



THE BEST ROOM IN THE HOUSE
ISN'T IN THE HOUSE AT ALL



2019 / 2020
PRODUCT CATALOG

INDEX

OUTDOOR FIREPLACES

Kalea Bay 6 - 9

FIRE FURNISHINGS

Sanctuary Series 12 - 15

BURNER SYSTEMS

Ignition Systems 18 - 19
Round Drop-In Pan 20 - 21
Round Flat 22 - 23
Square Drop-In Pan 24 - 25
Square Flat 26 - 27
Line of Fire Drop-In Pan 30 - 31
L-Series 32 - 35

BURNER KITS

Spur Kits 38
Ring Kits 39
H Kits 39

AnF

AnF Round 42 - 43
AnF Square 42 - 43
AnF Linear 42 - 43

SRW/ARCHITECTURAL BLOCK PRODUCTS

SRW Packages 46
SRW Control Panels 47
Flexframe 48
Vent Kits 49

JEWELRY

Media 52
Glass 52 - 53
Logs 54
How Much Media? 55

ACCESSORIES

E-Stop 58 - 59
Controls 60
Vent Kits 61
Windshields 62
Lids 63
Hoses & Regulators 64
Valves 65
Fittings 66
Flex Lines 66
Pans 67
Replacement Parts 68 - 69
Dealer Tools 70 - 71
Apparel 71
Gas Pipe Sizing 72
References 73
References 74 - 76





ABOUT US

Firegear would like to thank all of our past and present customers who have supported us throughout our 16-year history. We value your trust in us, and we will do our best to meet your service expectations. Rest assured, we will continually strive to earn your trust with each order placed. We work hard to stay abreast of all the nuances and changes in the outdoor category each day, and we stand committed to providing manufacturers, distributors, and dealers with quality products, information and technical support.

To provide extraordinary customer service is our primary goal. We do this by always having a human being answer the phone, by offering free Technical support and by promptly shipping all in house orders. In addition to the Technical support line, help videos are now available at www.firegearoutdoors.com to assist customers on their schedule.



ONLINE

Our catalog is a comprehensive list of all products we sell. We understand you may need more detailed information; including clearance to combustibles, product dimensions, etc. This information can be found on our website either in our Specification Book or our Installation Manuals.

You can find the specification book on the homepage of www.firegearoutdoors.com and click on the instructions tab.



OUTDOOR FIREPLACES





OFP-48LECO-N
OUTDOOR FIREPLACE

KALEA BAY

NEW VERSION!



WARNING - PROPOSITION 65

This product is designed to operate with one of the following fuel sources: Liquid Propane or Natural Gas. The fuel used to operate this product, and the products of combustion of such fuel, can expose you to chemicals including Benzene which is known to the State of California to cause cancer, birth defects and other reproductive harm and Carbon Monoxide which is known to the State of California to cause birth defects or other reproductive harm. (For more information go to: www.p65Warnings.ca.gov.)

OFP-72LECO-N
OUTDOOR FIREPLACE

*Picture shows "wood looking" tile, please refer to your installation manual for proper clearance to combustibles.

FEATURES

Clean contemporary outdoor linear gas fireplace, no chimney or venting required, ready for framing and finishing

Firebox and burner assembly constructed of weather/corrosion resistant 304 stainless steel

 **Ecoflow** Valve System: battery operated electronic ignition system provides reliable response and operation in humid, windy conditions

Easily converts to see-through with purchase of a Kalea Bay See-Through Conversion Kit

Control Center: On/Off, Low/High, Cont. Pilot & Learn with a battery drawer for easy access

Ships as Natural Gas (NG). Field convertible to Liquid Propane (LP). Conversion Kits sold separately

Intermittent or continuous pilot options

Drop-in burner system for ease of installation and serviceability

Control panel in 304 stainless steel enclosure

Safety valve turns off the gas in case of loss of flame

Tempered glass windshield to deter loss of flame in windy conditions

Each model includes two (2) 12"x6" vents to provide the required 18 square inches of cross ventilation

Optional controls include: On/Off/High/Low Remote Control, Wireless Timer, Wireless Wall On/Off Switch, Wireless Wall High/Low Controls and Home/Pool Automation System capabilities

Tested & Approved to: ANSI Z21.97-2014/CSA 2.41-2014 standards by Underwriters Laboratories

Built in the USA

MODELS

OFP-36LECO-N

36" W x 16" H Opening Dimensions

Natural Gas (31,000 Btu on High, 18,500 Btu on Low)

Liquid Propane (30,000 Btu on High, 19,500 Btu on Low)

OFP-60LECO-N

60" W x 16" H Opening Dimensions

Natural Gas (50,000 Btu on High, 36,000 Btu on Low)

Liquid Propane (50,000 Btu on High, 36,000 Btu on Low)

OFP-48LECO-N

48" W x 16" H Opening Dimensions

Natural Gas (43,500 Btu on High, 24,500 Btu on Low)

Liquid Propane (42,500 Btu on High, 29,000 Btu on Low)

OFP-72LECO-N

72" W x 16" H Opening Dimensions

Natural Gas (65,000 Btu on High, 42,000 Btu on Low)

Liquid Propane (60,000 Btu on High, 45,000 Btu on Low)



SINGLE-SIDED



SEE-THROUGH
Requires Conversion Kit

5

WARRANTY

Five (5) years on stainless steel components

2

WARRANTY

Two (2) years on gas valve, electronic components and pilot igniter assembly

1

WARRANTY

Commercial Applications, One (1) year warranty on all parts

Clifrock Kalea Bay Fireplace
by Nicolock featuring Firegear OFP-48LECO-N

NICOLOCK
paving stones & retaining walls



KALEA BAY CLEARANCES

SINGLE SIDED & SEE THROUGH

MODEL	OVERALL LENGTH	INSIDE OPENING	OVERALL HEIGHT	OPENING HEIGHT & DEPTH	LEG HEIGHT	VALVE BOX DEPTH	CLEARANCE TO SIDE WALL (SINGLE SIDED)	CLEARANCE TO SIDE WALL (SEE THROUGH)	CLEARANCE TO CEILING
OFP-36LECO-N	40"	36"	37 1/2"	16"	11 1/2"	8 3/4"	6"	36"	42 1/2"
OFP-48LECO-N	52"	48"	37 1/2"	16"	11 1/2"	8 3/4"	6"	36"	42 1/2"
OFP-60LECO-N	64"	60"	37 1/2"	16"	11 1/2"	8 3/4"	6"	36"	42 1/2"
OFP-72LECO-N	76"	72"	37 1/2"	16"	11 1/2"	8 3/4"	6"	36"	42 1/2"

KALEA BAY STRUCTURE

Kalea Bay - Single-Sided

Every Kalea Bay unit comes out of the box as a single-sided unit. But, it can be easily converted into a see-through unit.



Kalea Bay - See-Through Conversion Kits (Optional)

You can easily convert your Kalea Bay into a see-through unit with one of our See-Through Conversion Kits.



MODEL	SIZE	INCLUDES
73230	36"	Glass Windshield + Stainless Steel Hood
74230	48"	Glass Windshield + Stainless Steel Hood
75230	60"	Glass Windshield + Stainless Steel Hood
76230	72"	Glass Windshield + Stainless Steel Hood

CONTROL CENTER

The control center can be mounted within 6' of the fireplace. We also make the batteries accessible within the control center for easy maintenance.



Switch Layout



On / Off
Turn on and off the unit



Continuous Pilot
Keep the Pilot Light on



Low / High
Control the flame height



Learn
Add an accessory remote



Mounting Cut-Out Dimensions

5" Width x 5 5/8" Height

Control panel - Door Closed

WEATHER COVER

While the Kalea Bay boasts robust weather/corrosion resistant 304 stainless steel, sometimes the elements can be cruel. That's why we now offer a sturdy weather cover as an optional accessory to protect the burner system and media. Sometimes strong winds can lift media out of the pan, which can damage either the glass, pilot, or leave undesirable scratches or dents.

The weather cover is offered as an accessory for all our Kalea Bay models.

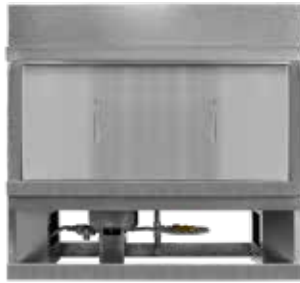

Models

- OFP-36COV
- OFP-48COV
- OFP-60COV
- OFP-72COV

ACCESSORIES



TM-R-AF1TX

Wireless Wall Timer (30min/60min/120min), twenty (20) foot range, surface mount, battery operated, uses two 3-volt button cell batteries (included)



1322WT

Wireless Wall Mount On/Off/High/Low Transmitter, twenty (20) foot range, surface mount, battery operated, uses two 3-volt button cell batteries (included)



1001D-AF1TX

Wireless wall mount switch (On/Off), twenty (20) foot range, surface mount, battery operated, uses two 3-volt button cell batteries (included)



WS

Wired wall mount switch (On/Off) with twenty (20) feet of low voltage wire



AF-4000HAT

Home/Pool Automation System Link (works with most manufacturers systems)



ADP10-OUT / ADP70-OUT

Outdoor 7.5 Vdc power adapter. Available in 10' length and 70' length



RCAF-3TX

3-Step battery-operated remote control to power an ON/OFF/Hi/LOW internal solenoid

FIRE FURNISHINGS



 **WARNING - PROPOSITION 65**

This product is designed to operate with one of the following fuel sources: Liquid Propane or Natural Gas. The fuel used to operate this product, and the products of combustion of such fuel, can expose you to chemicals including Benzene which is known to the State of California to cause cancer, birth defects and other reproductive harm and Carbon Monoxide which is known to the State of California to cause birth defects or other reproductive harm. (For more information go to: www.p65Warnings.ca.gov.)



SANCTUARY SERIES



 **WARNING - PROPOSITION 65**

This product is designed to operate with one of the following fuel sources: Liquid Propane or Natural Gas. The fuel used to operate this product, and the products of combustion of such fuel, can expose you to chemicals including Benzene which is known to the State of California to cause cancer, birth defects and other reproductive harm and Carbon Monoxide which is known to the State of California to cause birth defects or other reproductive harm. (For more information go to: www.p65Warnings.ca.gov.)

SAN2-34DBSTMSI-N
GFRC Fire Bowl

FEATURES

Firegear is proud to present our latest innovation in outdoor fire furnishings, the Sanctuary Series. Each Sanctuary fire furnishings is handcrafted using the highest quality materials and GIST molding/finishing process ensuring a beautiful one-of-a-kind finish with subtle variations in color and texture similar to natural stone.

Our linear model (Sanctuary 1) is equipped with TMSI technology offering variable flame height, modern safety features and spark ignition. We also offer two different sized round models with your choice of TMSI or MT burner systems.

Sanctuary structures are constructed of incredibly strong, weather resistant, long lasting GFRC (Glass Fiber Reinforced Concrete)

CSA or UL Certified Firegear Burner Systems in various different ignition systems

Each Sanctuary has been designed to provide a minimum of 18" square inches of cross ventilation for safety and proper drainage

Made in the USA

MODELS

Sanctuary 1

SAN1-30LHTMSI-N

Outdoor GFRC Fire Table - 430 lbs.

Dimensions: 56" width x 38" depth x 16" height

TMSI (Thermocouple Manual Safety with Spark Ignition) combining variable flame with safety features

Ships as Natural Gas. Liquid Propane (LP) conversion kit available.

Natural Gas: 65,000 BTU's

CSA Certified ANS Z21.97-2014/CSA 2.41-2014 Burner System

Includes weather cover

COLOR: SLATE



Perfectly sized for entertaining while enjoying the fire. The Sanctuary 1 provides plate room when outdoor entertaining.

Sanctuary 2

SAN2-34DBSTMSI-N

Outdoor GFRC Fire Bowl - 222 lbs.

Dimensions: 38 3/4" width x 18" height

TMSI (Thermocouple Manual Safety with Spark Ignition) combining variable flame, safety features and spark ignition.

Ships as Natural Gas. Liquid Propane (LP) conversion kit available.

Natural Gas: 65,000 BTU's

UL Certified ANS Z21.97-2014/CSA 2.41-2014 Burner System

Includes weather cover

SAN2-34DBSMT-N

Outdoor GFRC Fire Bowl - 222 lbs.

Dimensions: 38 3/4" width x 18" height

MT (Match Throw) variable flame with easy lighting with a butane lighter or match.

Ships as Natural Gas. Liquid Propane (LP) conversion kit available.

Natural Gas: 65,000 BTU's

UL Certified ANS Z21.97-2014/CSA 2.41-2014 Burner System

Includes weather cover

Sanctuary 3

SAN3-26DBSTMSI-N

Outdoor GFRC Fire Bowl - 112 lbs.

Dimensions: 30" width x 14 1/2" height

TMSI (Thermocouple Manual Safety with Spark Ignition) combining variable flame with safety features

Ships as Natural Gas. Liquid Propane (LP) conversion kit available.

Natural Gas: 65,000 BTU's

UL Certified ANS Z21.97-2014/CSA 2.41-2014 Burner System

Includes weather cover

SAN3-26DBSMT-N

Outdoor GFRC Fire Bowl - 112 lbs.

Dimensions: 30" width x 14 1/2" height

MT (Match Throw) variable flame with easy lighting with a butane lighter or match.

Ships as Natural Gas. Liquid Propane (LP) conversion kit available.

Natural Gas: 65,000 BTU's

UL Certified ANS Z21.97-2014/CSA 2.41-2014 Burner System

Includes weather cover



5

WARRANTY

Five (5) years on stainless steel components

2

WARRANTY

Two (2) years on gas valve, electronic components and pilot igniter assembly

1

WARRANTY

GFRC & Commercial Applications, One (1) year warranty on all parts

IGNITION SYSTEMS

TMSI (Thermocouple Manual Safety with Spark Ignition)

Tested and Approved to: ANSI Z21.97-2014/CSA 2.41-2014 standards by Underwriters Laboratories (UL)

Battery operated Manual Spark push button ignition

Safety Valve turns gas OFF if flame goes out

Fully adjustable flame height

MT (Match Throw)

Tested and Approved to: ANSI Z21.97-2014/CSA 2.41-2014 standards by Underwriters Laboratories (UL)

Key valve with key valve cover and 12" key

Fully adjustable flame height

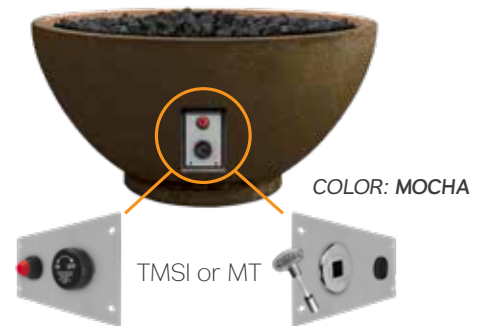
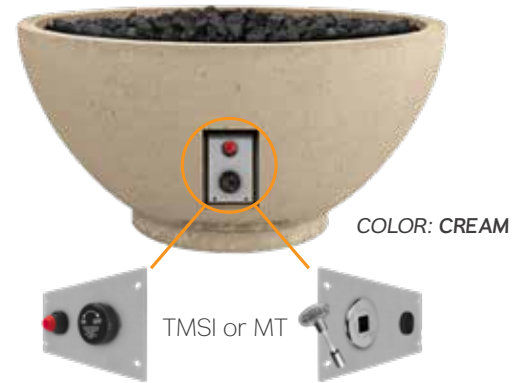

COLORS

Firegear offers a wide array of colors to fit any type of backyard or project setting.

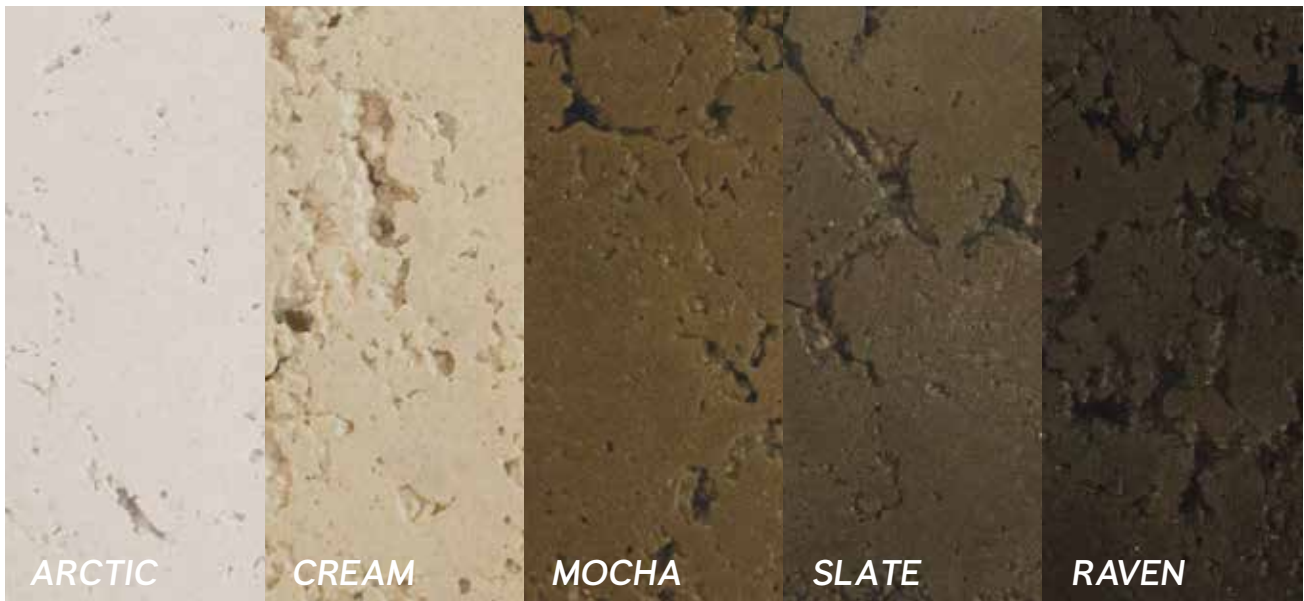

COLORS PRESENTED IN THIS CATALOG MAY NOT REPRESENT COLORS RECEIVED. We cannot guarantee that the color you see accurately portrays the true color of the product.

WEATHER COVER

Durable Rhinoweave fabric
Champagne Color
Breathable & Water resistant
Spring clinch lock offers secure fit.



SANCTUARY 1



SANCTUARY 2 & 3

PROPANE TANK HOLDER



COLOR: ARCTIC

Holds one (1) 20lb. tank with easy to remove top.
Model: SANCTUARY-LPTE
Weight: 135 lbs.
Dimensions: 20" wide x 21 1/2" height

ACCESSORIES



FG-LPQDK

Liquid propane quick disconnect kit - includes: 12' (144") 1/2" OD (3/8") ID gray PVC hose with quick disconnect fitting and socket dust cap, FG-LPRK liquid propane regulator, 3/8" MPT Adapter and ACME quick connect. CSA-AGA/CGA approved, rated at 80,000 BTU



LOF-BO-LP40

Liquid Propane (LP) Conversion Kit. Converts fire pit from Natural Gas to LP Gas. Includes: Orifice and instructions: For use with Sanctuary 1 models



LPK#41

Liquid Propane (LP) Conversion Kit. Converts fire pit from Natural Gas to LP Gas. Includes: Orifice/Air Shutter, rating plate label sticker and instructions - 65,000 BTU. For use with the Sanctuary 2 / 3 models.



Glass

Choose between large broken, large reflective, small reflective & beaded glass in an assortment of different colors.



Lava Rock

Mined from the earth, these dark rocks contrast beautifully against a bright flame. Each rock is approximately 1" - 2" in diameter.

BURNER SYSTEMS

ROUND & SQUARE



 **WARNING - PROPOSITION 65**

This product is designed to operate with one of the following fuel sources: Liquid Propane or Natural Gas. The fuel used to operate this product, and the products of combustion of such fuel, can expose you to chemicals including Benzene which is known to the State of California to cause cancer, birth defects and other reproductive harm and Carbon Monoxide which is known to the State of California to cause birth defects or other reproductive harm. (For more information go to: www.p65Warnings.ca.gov.)



Clifrock Ovation Round Fire Pit
Nicolock featuring Firegear Burner System (FPB-19RBSMT-N)

NICOLOCK
paving stones & retaining walls

TFS

Thermocouple Flame Sense

Firegear's TFS Electronic Ignition System comes fully assembled. No power, no problem. Our TFS systems do not require 110Vac and simply operate with four (4) AA batteries. You can place it virtually anywhere. Lighting the fire is at your fingertips using the provided On / Off / High / Low remote control. Don't want to use batteries? No problem, just add our A/C adapter ADP10-OUT / ADP70-OUT.

If you want to control your fire feature with your home / pool automation system, our AF-4000HAT works with most manufacturers systems. The TFS system features auto shut-off in case of flame loss. It will then auto re-light.

Tested and Approved to: ANSI Z21.97-2014/CSA 2.41-2014 standards by Underwriters Laboratories (UL)

Thermocouple Flame Sense TFS technology with Reliable Direct Spark Ignition (Non Piloted version)

Battery Operated Electronic Ignition with Safety Valve

Safety Valve turns gas OFF when flame goes out

High / Low adjustable flame height

Fully assembled and ready to install

Each unit ships with a 46' tranquiline flex line and all fittings necessary for installation

Pans Available in Round, Square and Flat Disc Configurations in a Variety of Sizes

Warranty: Five (5) year on stainless steel components. Two (2) years on gas valve, electronic components and pilot igniter assembly. Commercial Applications: One (1) year warranty on all parts

Optional Accessory: A/C adapter for continuous power - ADP10-OUT / ADP70-OUT

Optional Accessory: Home / Pool Automation Transmitter - AF-4000HAT

Optional Controls: Wired Wall Mount Switch, Wireless Wall Mount Switch, Wireless Wall Mount Timer, Wireless Wall Mount On/Off/High/Low

Must order gas specific (NG or LP)



How to Light

1. Press the ON button on the hand-held remote transmitter. You will hear the igniter probe begin sparking for fifteen (15) seconds and the flame will light .
2. To turn OFF the fire pit, simply press the OFF button on the remote control.

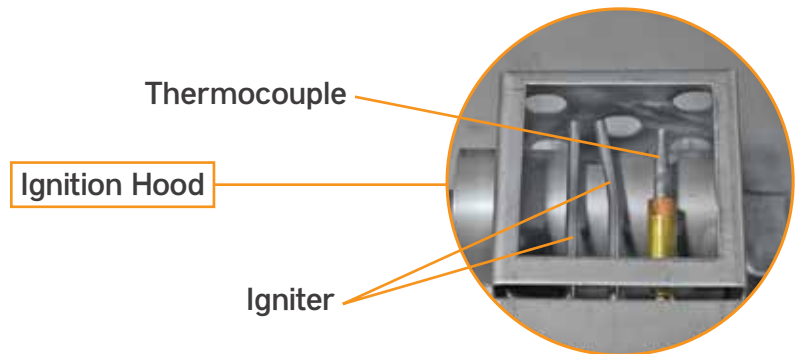

Image shown with screen off



Remote Systems

The TFS system has many optional accessories to choose from. You can learn up to three (3) different Skytech remotes on the same system

All thermocouple flame sense systems come standard with our RCAF-3TX. It's a wireless remote so you can ignite your fire pit anywhere within a 20 feet range. No more lighters, matches, or manual valves.



Home Automation

The AF-4000HAT Pool / Home Automation Transmitter allows you to operate your Firegear TFS product from the same controller you're using with your pool system or home automation system. It's important to note that even though you are using the HAT, you can still use your original remote that came with your TFS system.



Accessories

If you would prefer to NEVER change your batteries, we offer a 110V adapter in both a 10' and 70' lengths.

ADP10-OUT / ADP-70-OUT

TMSI

Thermocouple Manual Safety with Spark Ignition

Tested and Approved to: ANSI Z21.97-2014/CSA 2.41-2014 standards by Underwriters Laboratories (UL)

Thermocouple Manual Safety (TMSI) technology

Battery operated Manual Spark push button ignition

Safety Valve turns gas OFF if flame goes out

Fully adjustable flame height

Fully assembled & ready to install

Each unit ships with a mounting plate, 46" tranquiline flex line and all fittings necessary for installation

Pans available in round / square / flat configurations in a variety of sizes

Ships as Natural Gas, LP Conversion Kits available

Warranty: Five (5) years on stainless steel components. Two (2) years on gas valve, spark ignition components. Commercial Applications: One (1) year on all parts.



How to Light

1. Rotate the control knob on the gas valve counter-clockwise to the ON position.
2. Press the Spark Ignition button.
3. Press the control knob inward while pressing the spark ignition button.
4. After the fire pit lights, release the spark ignition button. Continue pressing the control knob for thirty (30) seconds, then release the control knob.
5. To turn OFF the fire pit, depress control knob slightly and turn clockwise to the OFF position.



MT

Match Throw

Tested and Approved to: ANSI Z21.97-2014/CSA 2.41-2014 standards by Underwriters Laboratories (UL)

Key valve with key valve cover and 12" key

Optional: Battery operated manual spark push button ignition

Fully adjustable flame height

Fully assembled and ready to install

Each unit ships with a 46" tranquiline flex line and all fittings necessary for installation

Pans available in round / square / flat configurations in a variety of sizes

Ships as Natural Gas, LP Conversion Kits available

Warranty: Five (5) years on stainless steel components. Two (2) years on gas valve, spark ignition components. Commercial Applications: One (1) year on all parts.



How to Light

1. Insert key into shut-off valve and secure key onto square end of the valve.
2. Light a long match or butane lighter and hold it near the burner.
3. Slowly turn the key counter-clockwise inside the gas valve (until it stops, which allows the gas to flow) and simultaneously apply the long burning match or Butane lighter as close to the end of the burner as possible.
4. To turn off the fire pit, insert key into key valve, turn the key clockwise until you feel a hard stop and the gas will shut off.



ROUND DROP-IN PAN SYSTEMS

TFS ROUND SYSTEMS



ACCESSORIES

WS Page 60

Wired wall mount switch (On/Off)

TM-R-AFITX Page 60

Wireless wall mount timer (30/60/120 min)

1001D-AFITX Page 60

Wireless wall mount switch (On/Off)

1322WT Page 60

Wireless wall mount On/Off/High/Low transmitter

AF-4000HAT Page 60

Home/Pool automation transmitter system

ADP10-OUT / ADP70-OUT Page 60

Outdoor 7.5 Vdc power adapter. Available in 10' and 70' models

VENT-KIT-6X12SS Page 61

Two (2) stainless steel 6" H x 12" W vents

LIDS Page 63

Stainless steel lids with brushed finish

MODEL	PAN SIZE	BURNER SIZE	IGNITION SYSTEM	GAS TYPE	BTU HIGH	BTU LOW
FPB-19RBSTFS-N	19"	16"	TFS	Natural	80,000	45,000
FPB-25RBSTFS-N	25"	22"	TFS	Natural	105,000	51,000
FPB-29RBSTFS-N	29"	22"	TFS	Natural	105,000	51,000
FPB-19RBSTFS-P	19"	16"	TFS	Propane	79,000	47,400
FPB-25RBSTFS-P	25"	22"	TFS	Propane	100,000	49,500
FPB-29RBSTFS-P	29"	22"	TFS	Propane	100,000	49,500

TMSI ROUND SYSTEMS



ACCESSORIES

E-STOP Page 58

Mechanical gas timer valve with manual emergency shut-off. Available in 1 hr and 2.5 hr models.

LPK#41

Liquid propane (LP) conversion kit. Converts fire pit from Natural Gas (NG) to Liquid Propane Gas (LP). Includes: orifice / air shutter, rating plate label sticker and instructions.

For use with FPB-19 / 25 / 29 / 33 RBSTMSI-N

LIDS Page 63

Stainless steel lids with brushed finish

VENT-KIT-6X12SS Page 61

Two (2) stainless steel 6" H x 12" W vents

MODEL	PAN SIZE	BURNER SIZE	IGNITION SYSTEM	GAS TYPE	BTU HIGH	BTU LOW
FPB-19RBSTMSI-N	19"	16"	TMSI	Natural	65,500	N/A
FPB-25RBSTMSI-N	25"	22"	TMSI	Natural	65,500	N/A
FPB-29RBSTMSI-N	29"	22"	TMSI	Natural	65,500	N/A
FPB-33RBSTMSI-N	33"	22"	TMSI	Natural	65,500	N/A

MT ROUND SYSTEMS



ACCESSORIES

E-STOP Page 58

Mechanical gas timer valve with manual emergency shut-off. Available in 1 hr and 2.5 hr models.

LPK#47

Liquid Propane (LP) conversion kit. Converts fire pit from Natural Gas (NG) to Liquid Propane Gas (LP). Includes: orifice / air shutter, rating plate label sticker and instructions.

For use with FPB-16RBSMT-N, 45,000 BTU

VENT-KIT-6X12SS Page 61

Two (2) stainless steel 6" H x 12" W vents

LIDS Page 63

Stainless steel lids with brushed finish

LPK#41

Liquid propane (LP) conversion kit. Converts fire pit from Natural Gas (NG) to Liquid Propane Gas (LP). Includes: orifice / air shutter, rating plate label sticker and instructions.

For use with FPB-19 / 25 / 29 / 33 RBSMTS-N

MSI-BSMTI

Manual spark ignition kit for FPB series match throw systems featuring the burning spur.

Kit includes: mounting plate, spark igniter module, ignition hood, ignition hood screen, igniter rain shield, 2-probe spark igniter, burner rain shield and bracket, ignition wiring and AAA battery.

MODEL	PAN SIZE	BURNER SIZE	IGNITION SYSTEM	GAS TYPE	BTU HIGH	BTU LOW
FPB-16RBSMT-N	16"	12"	MT	Natural	45,500	N/A
FPB-19RBSMT-N	19"	16"	MT	Natural	65,000	N/A
FPB-25RBSMT-N	25"	22"	MT	Natural	65,000	N/A
FPB-29RBSMT-N	29"	22"	MT	Natural	65,000	N/A
FPB-33RBSMT-N	33"	22"	MT	Natural	65,000	N/A

UNLISTED ROUND SYSTEMS



ACCESSORIES

OAS-LP45

Propane conversion kit (orifice / air shutter) for 16" burning spur. 55,000 BTU

OAS-LP35

Propane conversion kit (orifice / air shutter) for 22" burning spur. 99,000 BTU

OAS-LP29

Propane conversion kit (orifice / air shutter) for 31" burning spur. 150,000 BTU

VENT-KIT-6X12SS Page 61

Two (2) stainless steel 6" H x 12" W vents

E-STOP Page 58

Mechanical gas timer valve with manual emergency shut-off. Available in 1 hr and 2.5 hr models.

LIDS Page 63

Stainless steel lids with brushed finish

MODEL	PAN SIZE	BURNER SIZE	IGNITION SYSTEM	GAS TYPE	BTU HIGH	BTU LOW
FPB-29RBS22MT-N	29"	22"	MT	Natural	119,000	N/A
FPB-33RBS31MT-N	33"	31"	MT	Natural	171,000	N/A



WARNING - PROPOSITION 65

This product is designed to operate with one of the following fuel sources: Liquid Propane or Natural Gas. The fuel used to operate this product, and the products of combustion of such fuel, can expose you to chemicals including Benzene which is known to the State of California to cause cancer, birth defects and other reproductive harm and Carbon Monoxide which is known to the State of California to cause birth defects or other reproductive harm. (For more information go to: www.p65Warnings.ca.gov.)



CUSTOM PROJECTS!

Firegear offers Custom designed and built outdoor fire features to fit your specifications for both Residential and Commercial applications. For more details visit www.firegearoutdoors.com/customform

ROUND FLAT SYSTEMS

TFS ROUND FLAT SYSTEMS



ACCESSORIES

- WS** [Page 60](#)
Wired wall mount switch (On/Off)
- TM-R-AFITX** [Page 60](#)
Wireless wall mount timer (30/60/120 min)
- 1001D-AFITX** [Page 60](#)
Wireless wall mount switch (On/Off)
- 1322WT** [Page 60](#)
Wireless wall mount On/Off/High/Low transmitter
- AF-4000HAT** [Page 60](#)
Home/Pool automation transmitter system
- ADP10-OUT / ADP70-OUT** [Page 60](#)
Outdoor 7.5 Vdc power adapter. Available in 10' and 70' models
- VENT-KIT-6X12SS** [Page 61](#)
Two (2) stainless steel 6" H x 12" W vents

MODEL	PAN SIZE	BURNER SIZE	IGNITION SYSTEM	GAS TYPE	BTU HIGH	BTU LOW
FPB-29DBSTFS-N	29"	22"	TFS	Natural	105,000	51,000
FPB-29DBSTFS-P	29"	22"	TFS	Propane	100,000	49,500

TMSI ROUND FLAT SYSTEMS



ACCESSORIES

- E-STOP** [Page 58](#)
Mechanical gas timer valve with manual emergency shut-off. Available in 1 hr and 2.5 hr models.
- LPK#41**
Liquid propane (LP) conversion kit. Converts fire pit from Natural Gas (NG) to Liquid Propane Gas (LP). Includes: orifice / air shutter, rating plate label sticker and instructions.
For use with FPB-19 / 25 / 29 / 33 RBSTMSI-N
- VENT-KIT-6X12SS** [Page 61](#)
Two (2) stainless steel 6" H x 12" W vents

MODEL	PAN SIZE	BURNER SIZE	IGNITION SYSTEM	GAS TYPE	BTU HIGH	BTU LOW
FPB-26DBSTMSI-N	26"	16"	TMSI	Natural	65,500	N/A
FPB-29DBSTMSI-N	29"	22"	TMSI	Natural	65,500	N/A
FPB-34DBSTMSI-N	34"	22"	TMSI	Natural	65,500	N/A

MT ROUND FLAT SYSTEMS



ACCESSORIES

E-STOP [Page 58](#)

Mechanical gas timer valve with manual emergency shut-off. Available in 1 hr and 2.5 hr models.

LPK#41

Liquid propane (LP) conversion kit. Converts fire pit from Natural Gas (NG) to Liquid Propane Gas (LP). Includes: orifice / air shutter, rating plate label sticker and instructions.

For use with FPB-29 / 34 / 44 RBSTMSI-N

MSI-BSMTI

Manual spark ignition kit for FPB series match throw systems featuring the burning spur.

Kit includes: mounting plate, spark igniter module, ignition hood, ignition hood screen, igniter rain shield, 2-probe spark igniter, burner rain shield and bracket, ignition wiring and AAA battery.

VENT-KIT-6X12SS [Page 61](#)

Two (2) stainless steel 6" H x 12" W vents

MODEL	PAN SIZE	BURNER SIZE	IGNITION SYSTEM	GAS TYPE	BTU HIGH	BTU LOW
FPB-26DBSMT-N	26"	16"	MT	Natural	65,000	N/A
FPB-29DBSMT-N	29"	22"	MT	Natural	65,000	N/A
FPB-34DBSMT-N	34"	22"	MT	Natural	65,000	N/A

UNLISTED ROUND FLAT SYSTEMS



ACCESSORIES

OAS-LP35

Propane conversion kit (orifice / air shutter) for 22" burning spur. 99,000 BTU

OAS-LP29

Propane conversion kit (orifice / air shutter) for 31" burning spur. 150,000 BTU

OAS-LP25

Propane conversion kit (orifice / air shutter) for 36" burning spur. 180,000 BTU

VENT-KIT-6X12SS [Page 61](#)

Two (2) stainless steel 6" H x 12" W vents

E-STOP [Page 58](#)

Mechanical gas timer valve with manual emergency shut-off. Available in 1 hr and 2.5 hr models.

MODEL	PAN SIZE	BURNER SIZE	IGNITION SYSTEM	GAS TYPE	BTU HIGH	BTU LOW
FPB-29DBS22MT-N	29"	22"	MT	Natural	119,000	N/A
FPB-34DBS31MT-N	34"	31"	MT	Natural	171,000	N/A
FPB-44DBS36MT-N	44"	36"	MT	Natural	230,000	N/A

WARNING - PROPOSITION 65

This product is designed to operate with one of the following fuel sources: Liquid Propane or Natural Gas. The fuel used to operate this product, and the products of combustion of such fuel, can expose you to chemicals including Benzene which is known to the State of California to cause cancer, birth defects and other reproductive harm and Carbon Monoxide which is known to the State of California to cause birth defects or other reproductive harm. (For more information go to: www.p65Warnings.ca.gov.)

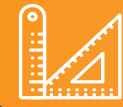

CUSTOM PROJECTS!
Firegear offers Custom designed and built outdoor fire features to fit your specifications for both Residential and Commercial applications. For more details visit www.firegearoutdoors.com/customform

SQUARE DROP-IN PAN SYSTEMS

TFS SQUARE SYSTEMS



ACCESSORIES

WS [Page 60](#)

Wired wall mount switch (On/Off)

TM-R-AFITX [Page 60](#)

Wireless wall mount timer (30/60/120 min)

1001D-AFITX [Page 60](#)

Wireless wall mount switch (On/Off)

1322WT [Page 60](#)

Wireless wall mount On/Off/High/Low transmitter

AF-4000HAT [Page 60](#)

Home/Pool automation transmitter system

ADP10-OUT / ADP70-OUT [Page 60](#)

Outdoor 7.5 Vdc power adapter. Available in 10' and 70' models

VENT-KIT-6X12SS [Page 61](#)

Two (2) stainless steel 6" H x 12" W vents

LIDS [Page 63](#)

Stainless steel lids with brushed finish

WINDSHIELDS [Page 62](#)

Tempered glass windshields

MODEL	PAN SIZE	BURNER SIZE	IGNITION SYSTEM	GAS TYPE	BTU HIGH	BTU LOW
FPB-20SBSTFS-N	20"	16"	TFS	Natural	80,000	48,000
FPB-20SBSTFS-P	20"	16"	TFS	Propane	79,000	47,400

TMSI SQUARE SYSTEMS



ACCESSORIES

E-STOP [Page 58](#)

Mechanical gas timer valve with manual emergency shut-off. Available in 1 hr and 2.5 hr models.

LPK#41

Liquid propane (LP) conversion kit. Converts fire pit from Natural Gas (NG) to Liquid Propane Gas (LP). Includes: orifice / air shutter, rating plate label sticker and instructions.

For use with FPB-20 / 26 / 32 / 38 SBSTMSI-N

VENT-KIT-6X12SS [Page 61](#)

Two (2) stainless steel 6" H x 12" W vents

LIDS [Page 63](#)

Stainless steel lids with brushed finish

WINDSHIELDS [Page 62](#)

Tempered glass windshields

MODEL	PAN SIZE	BURNER SIZE	IGNITION SYSTEM	GAS TYPE	BTU HIGH	BTU LOW
FPB-20SBSTMSI-N	20"	16"	TMSI	Natural	65,500	N/A

MT SQUARE SYSTEMS

ACCESSORIES



E-STOP [Page 58](#)

Mechanical gas timer valve with manual emergency shut-off. Available in 1 hr and 2.5 hr models.

LPK#41

Liquid propane (LP) conversion kit. Converts fire pit from Natural Gas (NG) to Liquid Propane Gas (LP). Includes: orifice / air shutter, rating plate label sticker and instructions.

For use with FPB-20 / 26 / 32 / 38 SBSMT-N

LIDS [Page 63](#)

Stainless steel lids with brushed finish

MSI-BSMTI

Manual spark ignition kit for FPB series match throw systems featuring the burning spur.

Kit includes: mounting plate, spark igniter module, ignition hood, ignition hood screen, igniter rain shield, 2-probe spark igniter, burner rain shield and bracket, ignition wiring and AAA battery.

VENT-KIT-6X12SS [Page 61](#)

Two (2) stainless steel 6" H x 12" W vents

WINDSHIELDS [Page 62](#)

Tempered glass windshields

MODEL	PAN SIZE	BURNER SIZE	IGNITION SYSTEM	GAS TYPE	BTU HIGH	BTU LOW
FPB-20SBSMT-N	20"	16"	MT	Natural	65,000	N/A



WARNING - PROPOSITION 65

This product is designed to operate with one of the following fuel sources: Liquid Propane or Natural Gas. The fuel used to operate this product, and the products of combustion of such fuel, can expose you to chemicals including Benzene which is known to the State of California to cause cancer, birth defects and other reproductive harm and Carbon Monoxide which is known to the State of California to cause birth defects or other reproductive harm. (For more information go to: www.p65Warnings.ca.gov.)



CUSTOM PROJECTS!

Firegear offers Custom designed and built outdoor fire features to fit your specifications for both Residential and Commercial applications. For more details visit www.firegearoutdoors.com/customform



SQUARE FLAT SYSTEMS

TFS SQUARE FLAT SYSTEMS



ACCESSORIES

WS Page 60

Wired wall mount switch (On/Off)

TM-R-AFITX Page 60

Wireless wall mount timer (30/60/120 min)

1001D-AFITX Page 60

Wireless wall mount switch (On/Off)

1322WT Page 60

Wireless wall mount On/Off/High/Low transmitter

AF-4000HAT Page 60

Home/Pool automation transmitter system

ADP10-OUT / ADP70-OUT Page 60

Outdoor 7.5 Vdc power adapter. Available in 10' and 70' models

VENT-KIT-6X12SS Page 61

Two (2) stainless steel 6" H x 12" W vents

MODEL	PAN SIZE	BURNER SIZE	IGNITION SYSTEM	GAS TYPE	BTU HIGH	BTU LOW
FPB-25SFBSTFS-N	25"	22"	TFS	Natural	105,000	51,000
FPB-25SFBSTFS-P	25"	22"	TFS	Propane	100,000	49,500

TMSI SQUARE FLAT SYSTEMS

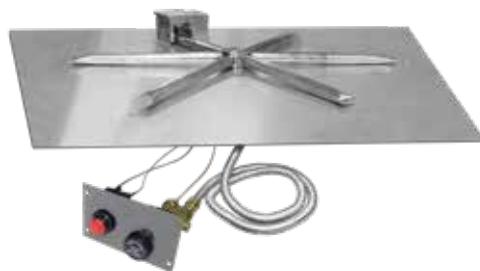

ACCESSORIES

E-STOP Page 58

Mechanical gas timer valve with manual emergency shut-off. Available in 1 hr and 2.5 hr models.

LPK#41

Liquid propane (LP) conversion kit. Converts fire pit from Natural Gas (NG) to Liquid Propane Gas (LP). Includes: orifice / air shutter, rating plate label sticker and instructions.

For use with FPB-25 / 30 / 34 / 40 SFBSTMSI-N

VENT-KIT-6X12SS Page 61

Two (2) stainless steel 6" H x 12" W vents

MODEL	PAN SIZE	BURNER SIZE	IGNITION SYSTEM	GAS TYPE	BTU HIGH	BTU LOW
FPB-25SFBSTMSI-N	25"	22"	TMSI	Natural	65,000	N/A
FPB-30SFBSTMSI-N	30"	22"	TMSI	Natural	65,000	N/A
FPB-34SFBSTMSI-N	34"	22"	TMSI	Natural	65,000	N/A

MT SQUARE FLAT SYSTEMS



ACCESSORIES

E-STOP [Page 58](#)

Mechanical gas timer valve with manual emergency shut-off. Available in 1 hr and 2.5 hr models.

LPK#41

Liquid propane (LP) conversion kit. Converts fire pit from Natural Gas (NG) to Liquid Propane Gas (LP). Includes: orifice / air shutter, rating plate label sticker and instructions.

For use with FPB-25 / 30 / 34 / 40 / 46 FBSMT-N

MSI-BSMTI

Manual spark ignition kit for FPB series match throw systems featuring the burning spur.

Kit includes: mounting plate, spark igniter module, ignition hood, ignition hood screen, igniter rain shield, 2-probe spark igniter, burner rain shield and bracket, ignition wiring and AAA battery.

VENT-KIT-6X12SS [Page 61](#)

Two (2) stainless steel 6" H x 12" W vents

MODEL	PAN SIZE	BURNER SIZE	IGNITION SYSTEM	GAS TYPE	BTU HIGH	BTU LOW
FPB-25SFBSMT-N	25"	22"	MT	Natural	65,000	N/A
FPB-30SFBSMT-N	30"	22"	MT	Natural	65,000	N/A
FPB-34SFBSMT-N	34"	22"	MT	Natural	65,000	N/A

UNLISTED SQUARE FLAT SYSTEMS

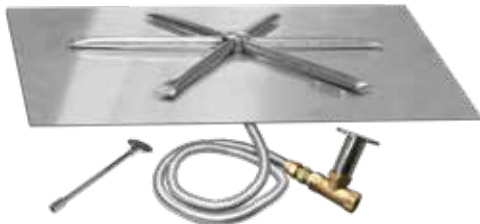

ACCESSORIES

OAS-LP35

Propane conversion kit (orifice / air shutter) for 22" burning spur. 99,000 BTU

OAS-LP29

Propane conversion kit (orifice / air shutter) for 31" burning spur. 150,000 BTU

OAS-LP25

Propane conversion kit (orifice / air shutter) for 36" burning spur. 180,000 BTU

VENT-KIT-6X12SS [Page 61](#)

Two (2) stainless steel 6" H x 12" W vents

E-STOP [Page 58](#)

Mechanical gas timer valve with manual emergency shut-off. Available in 1 hr and 2.5 hr models.

MODEL	PAN SIZE	BURNER SIZE	IGNITION SYSTEM	GAS TYPE	BTU HIGH	BTU LOW
FPB-25SFBS22MT-N	25"	22"	MT	Natural	119,000	N/A
FPB-30SFBS22MT-N	30"	22"	MT	Natural	119,000	N/A
FPB-34SFBS31MT-N	34"	31"	MT	Natural	171,000	N/A
FPB-40SFBS36MT-N*	40"	36"	MT	Natural	230,000	N/A
FPB-46SFBS36MT-N*	46"	36"	MT	Natural	230,000	N/A

* Special Order

WARNING - PROPOSITION 65

This product is designed to operate with one of the following fuel sources: Liquid Propane or Natural Gas. The fuel used to operate this product, and the products of combustion of such fuel, can expose you to chemicals including Benzene which is known to the State of California to cause cancer, birth defects and other reproductive harm and Carbon Monoxide which is known to the State of California to cause birth defects or other reproductive harm. (For more information go to: www.p65Warnings.ca.gov.)



CUSTOM PROJECTS!
 Firegear offers Custom designed and built outdoor fire features to fit your specifications for both Residential and Commercial applications. For more details visit www.firegearoutdoors.com/customform

BURNER SYSTEMS

LINEAR & RECTANGULAR



WARNING - PROPOSITION 65

This product is designed to operate with one of the following fuel sources: Liquid Propane or Natural Gas. The fuel used to operate this product, and the products of combustion of such fuel, can expose you to chemicals including Benzene which is known to the State of California to cause cancer, birth defects and other reproductive harm and Carbon Monoxide which is known to the State of California to cause birth defects or other reproductive harm. (For more information go to: www.p65Warnings.ca.gov.)



Weston Kit Fireplace
Belgard featuring Firegear Burner System (LOF-48LHTMSI-N)

BELGARD

LINE OF FIRE DROP-IN PAN SYSTEMS

LINE OF FIRE - H BURNER

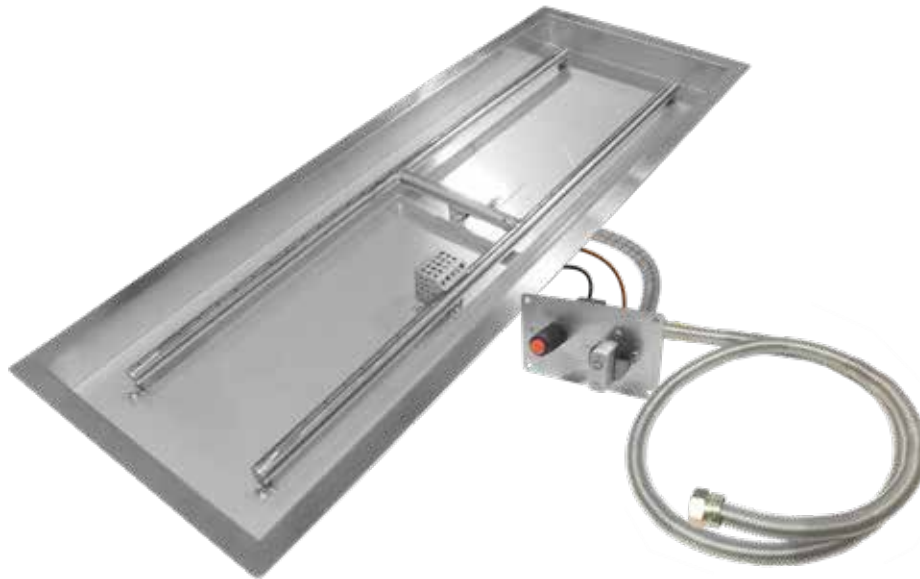

Heavy Duty Construction - Burner and pan feature 304 stainless steel construction

Spark Ignition - TMSI Thermocouple manual safety system with battery spark ignition

Linear Burner - Stainless steel burner provides a realistic flame presence

High BTU - These kits are designed with higher capacity orifices to provide a larger amount of flame

Includes - Burner, linear pan, gas flex line, TMSI safety valve, battery spark ignition system, and valve mounting plate

MODEL	PAN SIZE		BURNER SIZE	IGNITION SYSTEM	GAS TYPE	BTU (NG)
LOF-30LHTMSI-N	30" L x 10" W (inside dim)	32 1/2" L x 12 1/2" W (w/ lip)	26" x 6"	TMSI	Natural	65,000
LOF-36LHTMSI-N	36" L x 12" W (inside dim)	38 1/2" L x 14 1/2" W (w/ lip)	32" x 8"	TMSI	Natural	65,000
LOF-48LHTMSI-N	48" L x 14" W (inside dim)	50 1/2" L x 16 1/2" W (w/ lip)	44" x 10"	TMSI (Piloted)	Natural	95,000

ACCESSORIES



E-STOP (1hr or 2.5hr)

Mechanical timer with manual emergency shut-off. Comes in 1 hour timer or 2.5 hour timer.

ESTOP1-0H / ESTOP2-5H



VENT-KIT-6X12SS

Two (2) stainless steel 6" height x 12" width vents with mounting screws. Each vent provides 18 square inches of ventilation.



Lids

Stainless steel lids with brushed finish.

LOF-30LHTMSI-N: LID-LOF30LH

LOF-36LHTMSI-N: LID-LOF36LH

LOF-48LHTMSI-N: LID-LOF48LH



LOF-BO-LP40

Liquid Propane (LP) conversion kit. Converts fire pit from Natural Gas (NG) to Liquid Propane Gas (LP).

For use with LOF-30LHTMSI-N & LOF-36LHTMSI-N



LOF-BOPO-LP21

Liquid Propane (LP) conversion kit. Converts fire pit from Natural Gas (NG) to Liquid Propane Gas (LP).

For use with LOF-48LHTMSI-N

CUSTOM PROJECTS!
 Firegear offers Custom designed and built outdoor fire features to fit your specifications for both Residential and Commercial applications. For more details visit www.firegearoutdoors.com/customform

WARNING - PROPOSITION 65

This product is designed to operate with one of the following fuel sources: Liquid Propane or Natural Gas. The fuel used to operate this product, and the products of combustion of such fuel, can expose you to chemicals including Benzene which is known to the State of California to cause cancer, birth defects and other reproductive harm and Carbon Monoxide which is known to the State of California to cause birth defects or other reproductive harm. (For more information go to: www.p65Warnings.ca.gov)

LINE OF FIRE - T BURNER

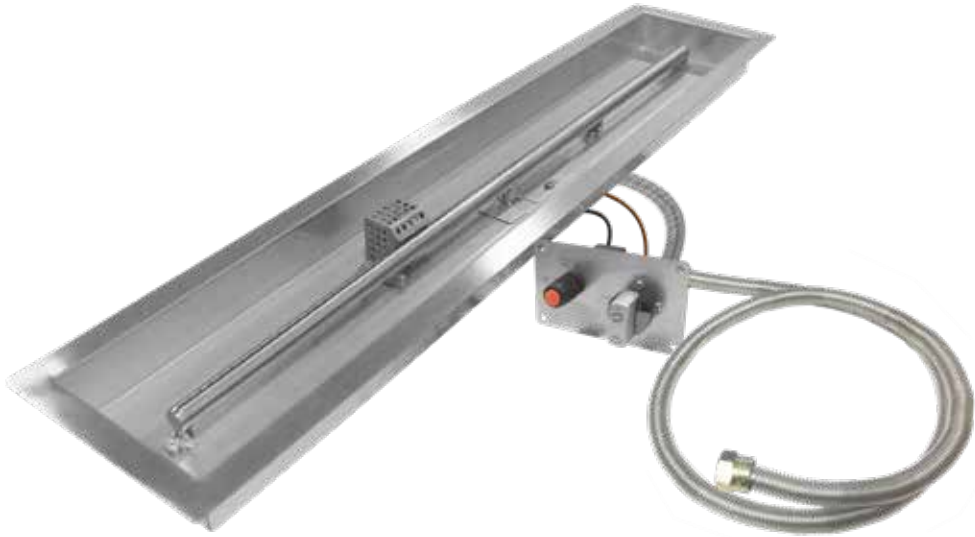

- Heavy Duty Construction - Burner and pan feature 304 stainless steel construction
- Spark Ignition - TMSI Thermocouple manual safety system with battery spark ignition
- Linear Burner - Stainless steel burner provides a realistic flame presence
- High BTU - These kits are designed with higher capacity orifices to provide a larger amount of flame
- Includes - Burner, linear pan, gas flex line, TMSI safety valve, battery spark ignition system, and valve mounting plate

MODEL	PAN SIZE		BURNER SIZE	IGNITION SYSTEM	GAS TYPE	BTU (NG)
LOF-30LTTMSI-N	30" L x 6" W (inside dim)	32 1/2" L x 8 1/2" W (w/ lip)	27"	TMSI	Natural	65,000
LOF-36LTTMSI-N	36" L x 6" W (inside dim)	38 1/2" L x 8 1/2" W (w/ lip)	33"	TMSI	Natural	65,000
LOF-48LTTMSI-N	48" L x 6" W (inside dim)	50 1/2" L x 8 1/2" W (w/ lip)	45"	TMSI (Piloted)	Natural	95,000
LOF-60LTTMSI-N	60" L x 6" W (inside dim)	62 1/2" L x 8 1/2" W (w/ lip)	47"	TMSI (Piloted)	Natural	95,000

ACCESSORIES



E-STOP (1hr or 2.5hr)
 Mechanical timer with manual emergency shut-off. Comes in 1 hour timer or 2.5 hour timer.
 ESTOP1-0H / ESTOP2-5H



VENT-KIT-6X12SS
 Two (2) stainless steel 6" height x 12" width vents with mounting screws. Each vent provides 18 square inches of ventilation.



Lids
 Stainless steel lids with brushed finish.
 LOF-30LTTMSI-N: LID-LOF-30LT
 LOF-36LTTMSI-N: LID-LOF-36LT
 LOF-48LTTMSI-N: LID-LOF-48LT
 LOF-60LTTMSI-N: LID-LOF-60LT



Windshields
 Stainless steel lids with brushed finish.
 LOF-30LTTMSI-N: GWS-3810
 LOF-36LTTMSI-N: GWS-4410
 LOF-48LTTMSI-N: GWS-6010
 LOF-60LTTMSI-N: GWS-8410



LOF-BO-LP40
 Liquid Propane (LP) conversion kit. Converts fire pit from Natural Gas (NG) to Liquid Propane Gas (LP).
 For use with LOF-30LTTMSI-N & LOF-36LTTMSI-N



LOF-BOPO-LP21
 Liquid Propane (LP) conversion kit. Converts fire pit from Natural Gas (NG) to Liquid Propane Gas (LP).
 For use with LOF-48LTTMSI-N & LOF-60LTTMSI-N

L-SERIES



Five (5) FPB-36LTFS-N installed of which Two (2) sets end to end, one (1) additional in the middle

FEATURES

The L Series is a heavy-duty, high-quality burner system designed with input from installation contractors looking for a simple, yet flexible design for linear gas fire pit projects. The burner is constructed from heavy-duty 304 stainless steel to create a long-lasting and durable product while the unique cradle design allows for adjustability to accommodate most thicknesses of your top finishing materials. The contemporary linear creates a realistic flame appearance. Firegear's unique thermocouple flame sensing TFS Systems are designed to provide a simple battery operated electronic ignition system that includes an automatic flame sensor to monitor the flame presence and shut off the gas supply in case of loss of flame. The L Series features an On/Off/High/Low operation at your fingertips with the Skytech RCAF-3TX remote control included. Prefer not to change batteries? No problem. Continuous power is as easy as adding one of our Outdoor rated 7.5 Vdc power adapters.

Designed to be able to fit two models end to end to create your desired length of burner.

Heavy Duty Construction - Burner features 304 stainless steel construction

Electronic Ignition - Thermocouple flame sensing (TFS) ignition system offers battery powered electronic ignition

Automatic Flame Sensor - Thermocouple monitors flame presence and shuts off gas supply if no flames are present

Remote Control - Included RCAF-3TX remote control allows On/Off/High/Low operation

Unique Cradle Design - Adjustable so that you can use various thickness top finishings materials.

Removable Burner pan - Simply lift the burner pan upward if service is necessary without disturbing your finishing materials

Tested and Approved to: ANSI Z21.97-2014/CSA 2.41-2014 standards by Underwriters Laboratories (UL)

Includes - Burner, linear cradle pan, flex line, electronic control box, remote / battery box and pilot assembly



TFS SYSTEM

Thermocouple Flame Sense Ignition system. Wireless remote included. No power required, all battery powered. A/C optional.

SIZES: 24' / 30' / 36'



MT SYSTEM

Simple & easy to operate Match Throw system. Use a butane lighter or match to start the flame.

SIZES: 24' / 30' / 36'

TFS L-SERIES



ACCESSORIES

WS Page 60

Wired wall mount switch (On/Off)

TM-R-AFITX Page 60

Wireless wall mount timer (30/60/120 min)

1001D-AFITX Page 60

Wireless wall mount switch (On/Off)

1322WT Page 60

Wireless wall mount On/Off/High/Low transmitter

AF-4000HAT Page 60

Home/Pool automation transmitter system

ADP10-OUT / ADP70-OUT Page 60

Outdoor 7.5 Vdc power adapter. Available in 10' and 70' models

LIDS Page 63

Stainless steel lids with brushed finish

WINDSHIELDS Page 62

Tempered glass windshields

TRIM Page 35

3/4" stainless steel decorative trim

MODEL	PAN SIZE	IGNITION SYSTEM	GAS TYPE	BTU HIGH	BTU LOW
FPB-24LTFS-N	24'	TFS	Natural	35,000	20,000
FPB-30LTFS-N	30'	TFS	Natural	42,000	23,000
FPB-36LTFS-N	36'	TFS	Natural	55,000	37,000
FPB-24LTFS-P	24'	TFS	Propane	35,000	20,000
FPB-30LTFS-P	30'	TFS	Propane	42,000	23,400
FPB-36LTFS-P	36'	TFS	Propane	55,000	37,500

MT L-SERIES



ACCESSORIES

LPK#50

Liquid propane (LP) conversion kit. Converts fire pit from Natural Gas to LP Gas. Includes: Orifice / Air Shutter, rating plate label sticker and instructions.

For use with FPB-24LMT-N, 35,000 BTU

LPK#48

Liquid propane (LP) conversion kit. Converts fire pit from Natural Gas to LP Gas. Includes: Orifice / Air Shutter, rating plate label sticker and instructions.

For use with FPB-30LMT-N, 45,000 BTU

E-STOP Page 58

Mechanical gas timer valve with manual emergency shut-off. Available in 1 hr and 2.5 hr models.

LPK#44

Liquid propane (LP) conversion kit. Converts fire pit from Natural Gas to LP Gas. Includes: Orifice / Air Shutter, rating plate label sticker and instructions.

For use with FPB-36LMT-N, 55,000 BTU

VENT-KIT-6X12SS Page 61

3/4" stainless steel decorative trim

LIDS Page 63

Stainless steel lids with brushed finish

WINDSHIELDS Page 62

Tempered glass windshields

TRIM Page 35

3/4" stainless steel decorative trim

MODEL	PAN SIZE	IGNITION SYSTEM	GAS TYPE	BTU HIGH	BTU LOW
FPB-24LMT-N	24'	MT	Natural	35,000	N/A
FPB-30LMT-N	30'	MT	Natural	45,000	N/A
FPB-36LMT-N	36'	MT	Natural	55,000	N/A



WARNING - PROPOSITION 65

This product is designed to operate with one of the following fuel sources: Liquid Propane or Natural Gas. The fuel used to operate this product, and the products of combustion of such fuel, can expose you to chemicals including Benzene which is known to the State of California to cause cancer, birth defects and other reproductive harm and Carbon Monoxide which is known to the State of California to cause birth defects or other reproductive harm. (For more information go to: www.p65Warnings.ca.gov)

TFS MODEL DIMENSIONS

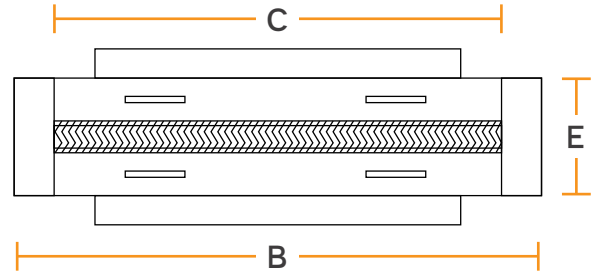
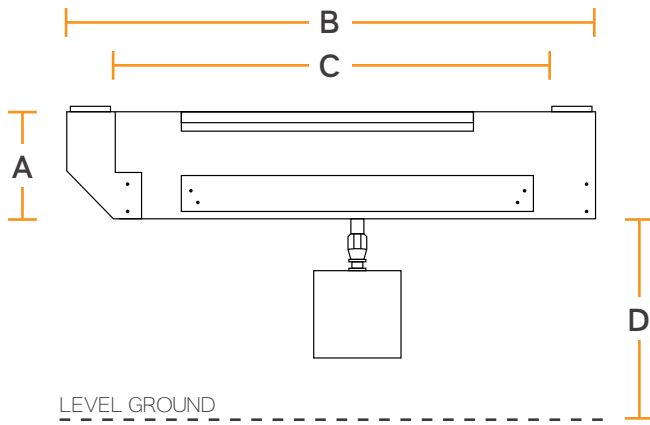

MODEL	A : PAN DEPTH	B : MIN INSTALL LENGTH	C : BURNER TUBE	D : FLOOR LEVEL	E : FRAMING WIDTH
FPB-24LTFS-N or P	4"	28.250"	24"	15"	7"
FPB-30LTFS-N or P	4"	34.250"	30"	15"	7"
FPB-36LTFS-N or P	4"	40.250"	36"	15"	7"

MT MODEL DIMENSIONS

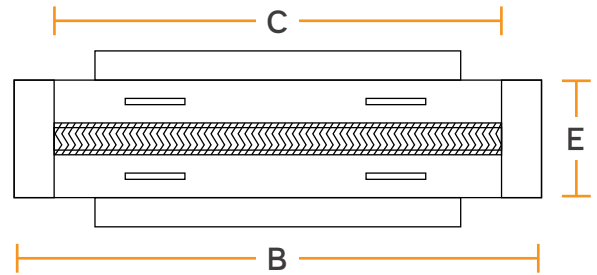
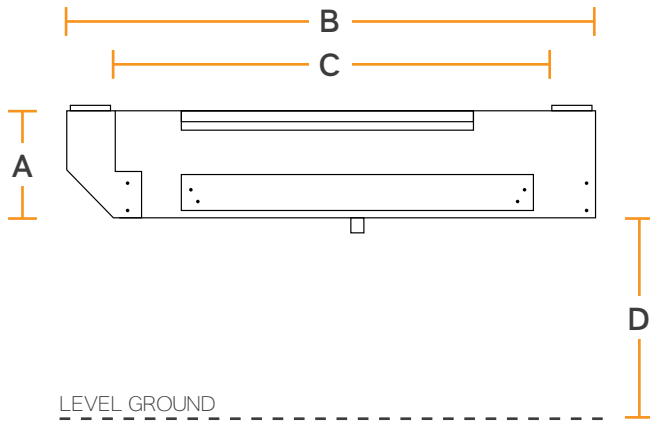

MODEL	A : PAN DEPTH	B : MIN INSTALL LENGTH	C : BURNER TUBE	D : FLOOR LEVEL	E : FRAMING WIDTH
FPB-24LTFS-N or P	4"	28.250"	24"	1"	7"
FPB-30LTFS-N or P	4"	34.250"	30"	1"	7"
FPB-36LTFS-N or P	4"	40.250"	36"	1"	7"

HEIGHT CONTROL



Each L-Series burner system comes with 2 cradle brackets that are adjustable so that you can achieve your desired height in order for the burner system to be flush with the surrounding enclosure.

COMBINING L-SERIES MODELS

The L-Series is designed to be able to fit two models end to end to create your desired length of burner. On the end of the L-Series burner system there is an extension bracket. By taking off the extension bracket on each unit you are able to connect the ends and create a flush finish. Combine any 24 / 30 / 36 inch system with one another to create your custom burner system.

2 TFS Units

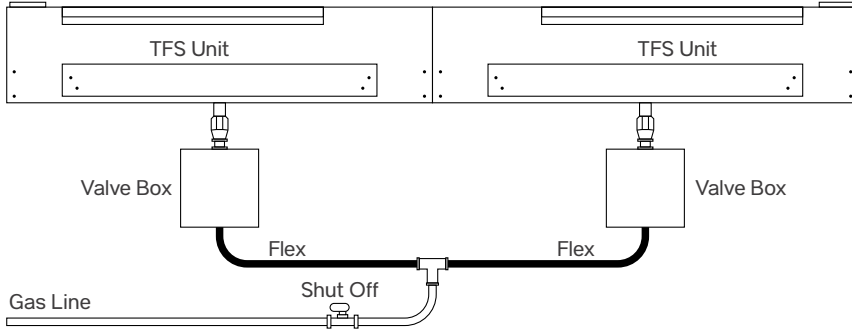

COMBINATION SIZE	MODEL	MODEL
48" Length	FPB-24L	FPB-24L
54" Length	FPB-24L	FPB-30L
60" Length	FPB-30L	FPB-30L
66" Length	FPB-30L	FPB-36L
72" Length	FPB-36L	FPB-36L

2 MT Units

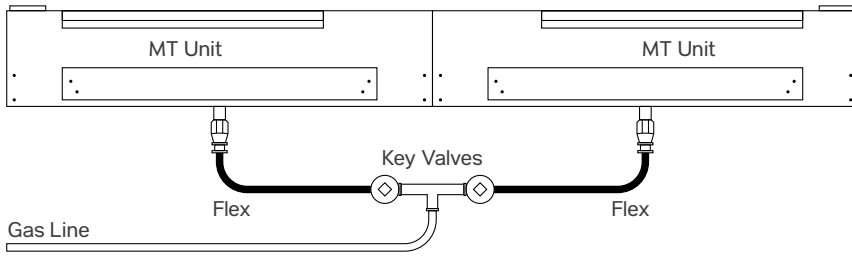

WINDSHIELDS

L-SERIES MODEL (S)	WINDSHIELD MODEL
FPB-24L	GWS-3810
FPB-30L	GWS-3810
FPB-36L	GWS-4410
FPB-24L + FPB-24L	GWS-6010
FPB-24L + FPB-30L	GWS-6010
FPB-30L + FPB-30L	GWS-8410
FPB-30L + FPB-36L	GWS-8410
FPB-36L + FPB-36L	GWS-8410



STAINLESS STEEL LIDS

L-SERIES MODEL (S)	LID MODEL
FPB-24L	LID-24L
FPB-30L	LID-30L
FPB-36L	LID-36L
FPB-24L + FPB-24L	LID-60L
FPB-30L + FPB-30L	LID-68L
FPB-36L + FPB-36L	LID-84L



DECORATIVE TRIM

L-SERIES MODEL (S)	TRIM MODEL
FPB-24L	TRIM-L24
FPB-30L	TRIM-L30
FPB-36L	TRIM-L36
FPB-24L + FPB-24L	TRIM-L48
FPB-30L + FPB-30L	TRIM-L60
FPB-36L + FPB-36L	TRIM-L72



We offer a 3/4" decorative brushed stainless steel trim piece to accent the L-Series burner system. We have (in stock) all the trim sizes to fit any L-Series or L-Series combination.

BURNER KITS



WARNING - PROPOSITION 65

This product is designed to operate with one of the following fuel sources: Liquid Propane or Natural Gas. The fuel used to operate this product, and the products of combustion of such fuel, can expose you to chemicals including Benzene which is known to the State of California to cause cancer, birth defects and other reproductive harm and Carbon Monoxide which is known to the State of California to cause birth defects or other reproductive harm. (For more information go to: www.p65Warnings.ca.gov.)



FPB-40SFBS36MT-N
OUTDOOR FIRE FEATURE

SPUR BURNER KITS

For a natural-looking flame that mimics a campfire, the Burning Spur's innovative design and superior construction (made of 304 stainless steel) is the choice of outdoor fire professionals. Backed by our five (5) year warranty, Firegear Burning Spurs will keep the fire going strong, season after season. To design the ultimate campfire feature, choose the Burning Spur Kit or pan/disc burner system that fits your design and ignition system. Pans and burners are available in a range of sizes, from 16" to 36".

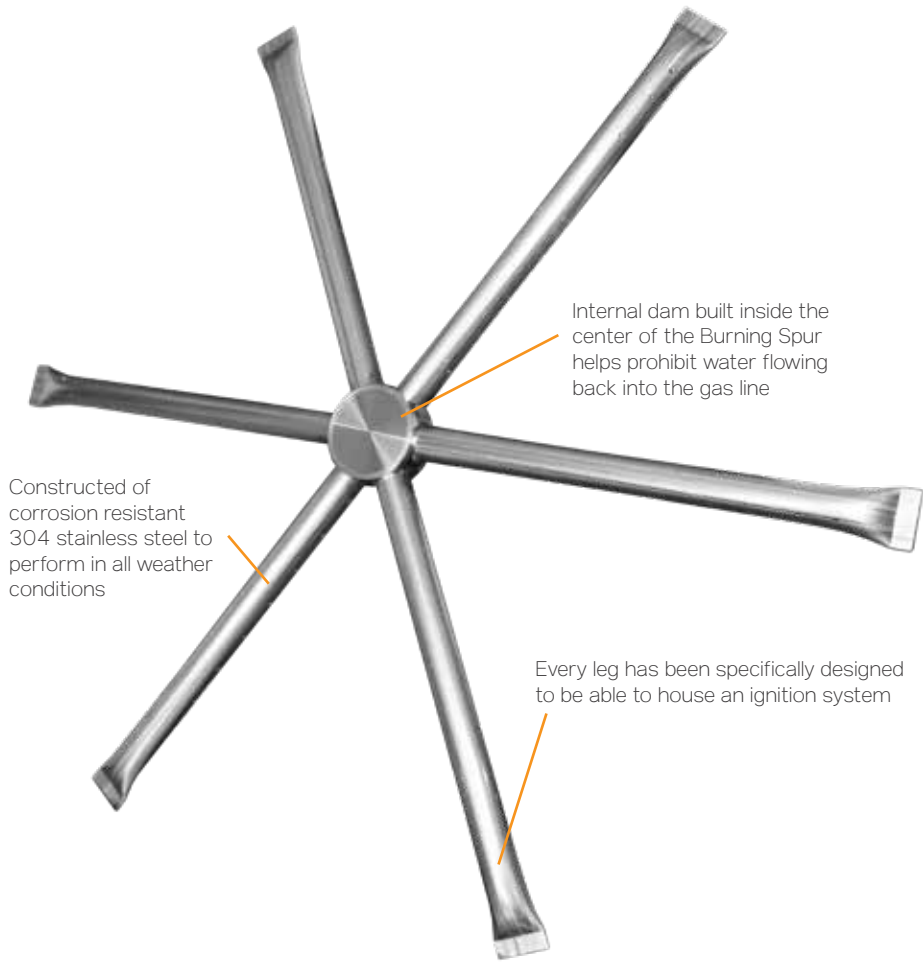

Constructed of corrosion resistant 304 stainless steel to perform in all weather conditions

Internal dam built inside the center of the Burning Spur helps prohibit water flowing back into the gas line

Every leg has been specifically designed to be able to house an ignition system

Features

The legs feature a pitched design letting water run off easily

The bottom hub features weep holes for water release so there is no freeze / thaw damage

LP conversion kits available in order to convert from Natural Gas to Propane

Cooling points between each spur leg helps prevent heat transfer to the outer edge

We offer a consumer warranty of five (5) years, also a commercial warranty of one (1) year

The stock sizes come in 12", 16", 22", 31", 36" (measured tip to tip)



KIT INCLUDES

- Burner
- Orifice
- Stainless Steel Tranquiline Gas Flex
- Fittings
- Key Valve
- Polished Chrome Key Valve Cover
- 12" Polished Chrome Key

Add an E-Stop



E-STOP (1hr or 2.5hr) [Page 58](#)

Mechanical timer with manual emergency shut-off. Comes in 1 hour timer or 2.5 hour timer.

MODEL	DESCRIPTION	LP ORIFICE	BTU NG	BTU LP
DBS-12K	12' - 304 Stainless steel burning spur	OAS-LP52	42,000	33,000
DBS-16K	16' - 304 Stainless steel burning spur	OAS-LP45	60,000	55,000
DBS-22K	22' - 304 Stainless steel burning spur	OAS-LP35	100,000	99,000
DBS-31K	31' - 304 Stainless steel burning spur	OAS-LP29	160,000	150,000
DBS-36K	36' - 304 Stainless steel burning spur	OAS-LP25	183,000	182,000

FIRE RING KITS



FEATURES

Constructed of 304 Stainless Steel
 Burner ports are drilled, not punched for an improved, quieter burner
 Ships as Natural Gas (NG), Liquid Propane (LP) conversion kits available

KIT INCLUDES

304 stainless steel fire ring with orifice (NG) - 30 / 36 / 48 orifice not included

Add an E-Stop



E-STOP (1hr or 2.5hr) Page 58

Mechanical timer with manual emergency shut-off. Comes in 1 hour timer or 2.5 hour timer.

MODEL	SIZE	DESCRIPTION	BTU NG	HUB SIZE	LP CON. KIT	BTU LP
FG-FR-6SSK	6'	6' single ring stainless steel ring burner kit	42,000	1/2" NPT	FR-OAS-LPK52	33,000
FG-FR-12SSK	12'	12' double ring stainless steel ring burner kit	42,000	1/2" NPT	FR-OAS-LPK52	33,000
FG-FR-18SSK	18'	18' double ring stainless steel ring burner kit	60,000	1/2" NPT	FR-OAS-LPK45	55,000
FG-FR-24SSK	24'	24' double ring stainless steel ring burner kit	100,000	1/2" NPT	FR-OAS-LPK35	99,500
FG-FR-30SSK	30'	30' triple ring stainless steel ring burner kit	up to 300,000	*3/4" NPT	FR-OAS-LPK4	300,000
FG-FR-36SSK	36'	36' triple ring stainless steel ring burner kit	up to 300,000	*3/4" NPT	FR-OAS-LPK4	300,000
FG-FR-48SSK	48'	48' triple ring stainless steel ring burner kit	up to 300,000	*3/4" NPT	FR-OAS-LPK4	300,000

* Includes 3/4" to 1/2" adapter, no orifice included

H BURNER KITS



FEATURES

Constructed of 304 Stainless Steel
 Burner ports are drilled, not punched for an improved, quieter burner
 Ships as Natural Gas (NG), Liquid Propane (LP) conversion kits available
 Easy to install center gas inlet

KIT INCLUDES

Burner, Orifice, Stainless Steel Tranquiline Gas Flex Line, Fittings, Key Valve, Polished Chrome Key Valve Cover, 12" Polished Chrome Key

Add an E-Stop



E-STOP (1hr or 2.5hr) Page 58

Mechanical timer with manual emergency shut-off. Comes in 1 hour timer or 2.5 hour timer.

MODEL	SIZE	DESCRIPTION	BTU NG	LP CON. KIT	BTU LP
FG-H-24SSK	24" x 6"	H style stainless steel burner	90,000	H-OAS-LP37	88,000
FG-H-30SSK	30" x 6"	H style stainless steel burner	120,000	H-OAS-LP31	117,000
FG-H-36SSK	36" x 6"	H style stainless steel burner	150,000	H-OAS-LP29	150,000
FG-H-48SSK	48" x 6"	H style stainless steel burner	170,000	H-OAS-LP27	168,500



WARNING - PROPOSITION 65

This product is designed to operate with one of the following fuel sources: Liquid Propane or Natural Gas. The fuel used to operate this product, and the products of combustion of such fuel, can expose you to chemicals including Benzene which is known to the State of California to cause cancer, birth defects and other reproductive harm and Carbon Monoxide which is known to the State of California to cause birth defects or other reproductive harm. (For more information go to: www.p65Warnings.ca.gov.)



CUSTOM PROJECTS!
 Firegear offers Custom designed and built outdoor fire features to fit your specifications for both Residential and Commercial applications. For more details visit www.firegearoutdoors.com/customform

AnF



WARNING - PROPOSITION 65

This product is designed to operate with one of the following fuel sources: Liquid Propane or Natural Gas. The fuel used to operate this product, and the products of combustion of such fuel, can expose you to chemicals including Benzene which is known to the State of California to cause cancer, birth defects and other reproductive harm and Carbon Monoxide which is known to the State of California to cause birth defects or other reproductive harm. (For more information go to: www.p65Warnings.ca.gov.)

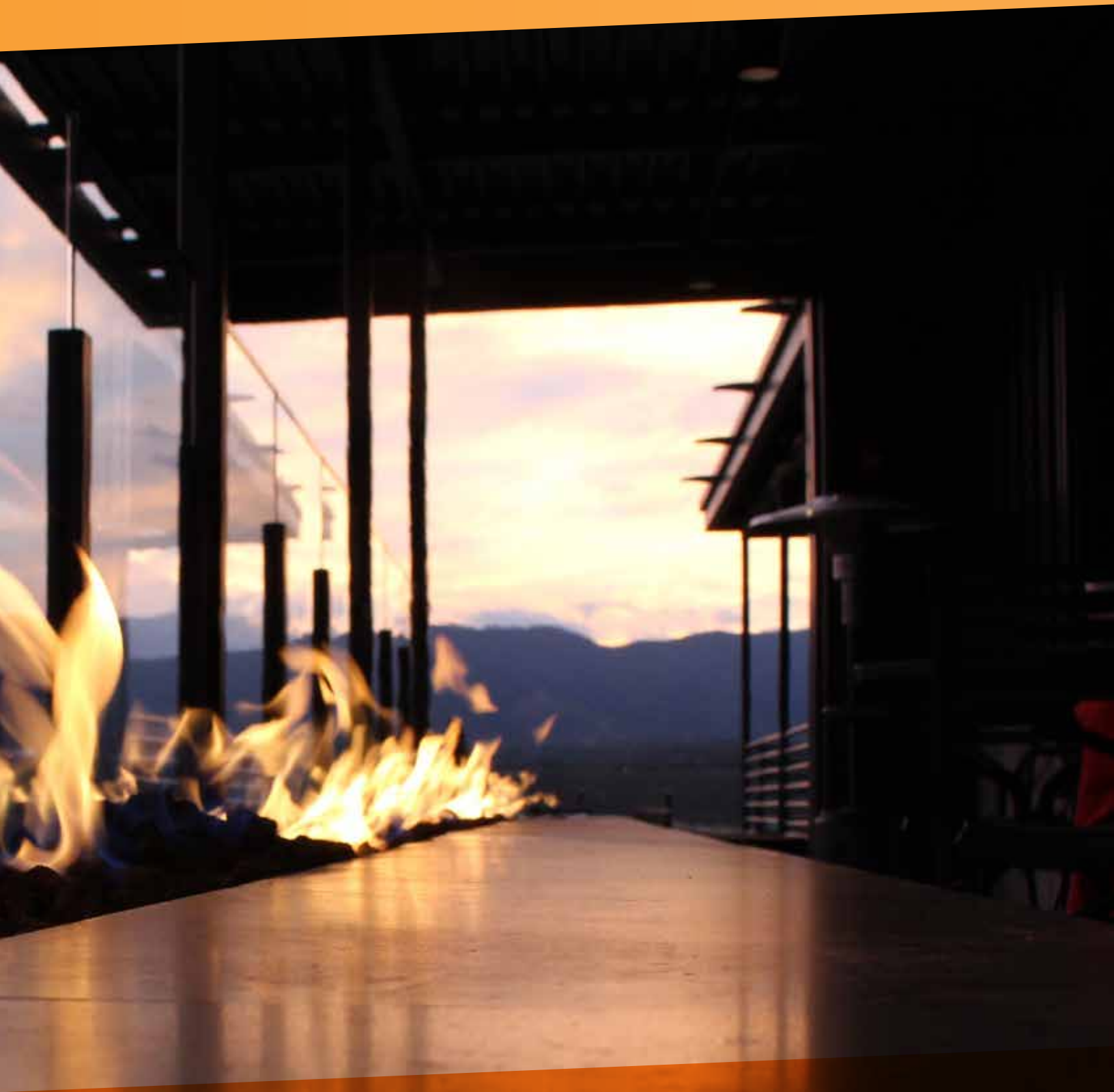

AnF - ASSEMBLE & FINISH



FEATURES

- Available in round, square and linear styles
- Simple assembly, typically around 30 minutes or less
- Automotive quality powder coat finish on all metal parts
- Supports up to 700 lbs.
- Heavy duty leveling legs with large flat pads
- Custom designed packaging protects the AnF from shipping damage
- Custom skid allows for stacking up to 3 high (Round Design)

- Knockdown design for ease of installation
- For easy shipping and installation, Individual sections are easily carried to the job site
- No heavy equipment required
- Each model includes two (2) Stainless Steel 12" x 6" vents to provide the required 18 square inches of cross ventilation (not installed)
- 5 Year Limited Warranty



ROUND AnF

Shipped in 4 pieces, the Round AnF provides a knock-down round design for easy shipping and quick installation. The round AnF can support a multitude of different burner pans.

SIZES: 42 / 48 / 60



SQUARE AnF

The square AnF can support a multitude of different burner types. The modular interior supports allow for complete customization.

SIZES: 48 / 60



LINEAR AnF

The linear AnF can support a multitude of different burner types. The modular interior supports allow for complete customization.

SIZES: 48 / 66* / 74* / 96*

*While supplies last

 **CUSTOM PROJECTS!**
Firegear offers Custom designed and built outdoor fire features to fit your specifications for both Residential and Commercial applications. For more details visit www.firegearoutdoors.com/customform

WHY THE AnF IS THE SUPERIOR ENCLOSURE

EXTRUDED ROUND AnF



LINEAR AnF CUT-AWAY

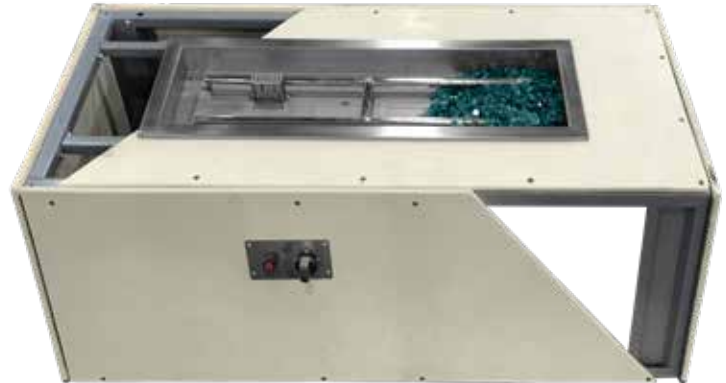

POWDER COATED

All steel is powder coated with Zinc Epoxy Primer which is engineered to protect from the outdoor elements. This type of powder coating is used in a number of applications including automotive.

BUILT TO LAST

Each AnF unit is built to last having been tested with 700 lbs, without structural failure and backed by a 5 Year Limited Warranty.

LEVELING LEGS

Heavy duty zinc plated leveling legs with large flat bottom for stability.

KNOCKDOWN

Knockdown design for easy shipping and quick installation.

FRAMEWORK

The AnF framework is constructed of 16 gauge galvanized steel.

EXTERIOR

The exterior panels are factory clad with 1/2" Permabase cement board. Permabase is impact resistant, extremely durable and dimensionally stable. It has overall flexural, compressive and tensile strength characteristics, highly moisture resistant and will not rot, disintegrate or swell when exposed to water.

ASSEMBLY



Using the screws for the body, screws for the pan supports, and leveling legs, construct the AnF and place it in your desired location. We provide a comprehensive installation guide in order to ensure the process goes smoothly.

PACKAGING & SHIPPING



Each AnF cabinet ships on its own specially designed skid. Round units can also be stacked three high for storage. We understand that packaging, shipping and storage can be one of the most difficult parts of enclosures.

SRW / ARCHITECTURAL BLOCK PRODUCTS



WARNING - PROPOSITION 65

This product is designed to operate with one of the following fuel sources: Liquid Propane or Natural Gas. The fuel used to operate this product, and the products of combustion of such fuel, can expose you to chemicals including Benzene which is known to the State of California to cause cancer, birth defects and other reproductive harm and Carbon Monoxide which is known to the State of California to cause birth defects or other reproductive harm. (For more information go to: www.p65Warnings.ca.gov.)



SQUARE FLAT SRW KIT PACKAGE
OUTDOOR FIRE FEATURE

SRW / ARCHITECTURAL BLOCK PACKAGES

..... SEGMENTED RETAINING WALL

WHAT'S IN A SRW KIT PACKAGE? WHY IS IT ADVANTAGEOUS?

Simply put? One model number, one package, one shipping number to track. By purchasing an SRW kit you get everything you need to build the interiors of your outdoor project. Burner system, vents, control segmented retaining wall kits, flexframe and media. It's all here. UL or CSA Listed to: ANSI Z21.97-2014/CSA 2.41-2014 standards by Underwriters Laboratories (UL)

ROUND FLAT SRW KIT PACKAGES

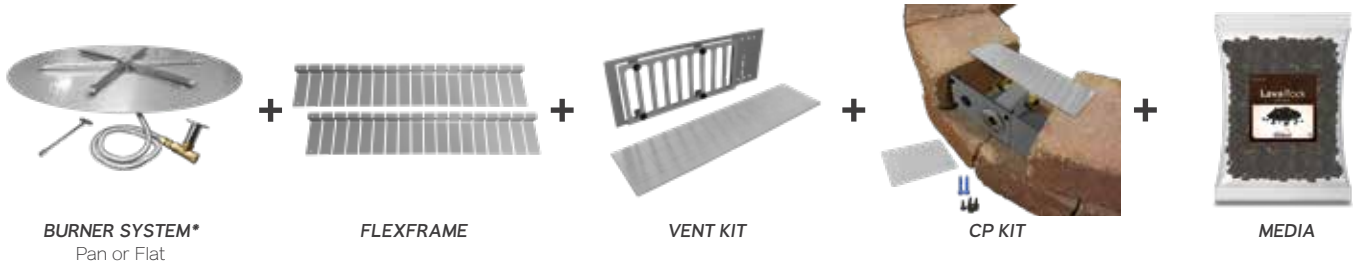

MODEL	IGNITION	PACKAGE INCLUDES
FPB-29DMTN-PK	MT	FPB-29DBSMT-N , FLEXFRAME-SS , PAVER-VENT-4LNTS , PAVER-CP-MT , FG-LAVA-10 (3)
FPB-29DTMSIN-PK	TMSI	FPB-29DBTMSI-N , FLEXFRAME-SS , PAVER-VENT-4LNTS , PAVER-CP-TMSI , FG-LAVA-10 (3)
FPB-29DTFSN-PK*	TFS	FPB-29DBSTFS-N , FLEXFRAME-SS , PAVER-VENT-4LNTS , FG-LAVA-10 (3)
FPB-34DMTN-PK	MT	FPB-34DBSMT-N , FLEXFRAME-SS3 , PAVER-VENT-4LNTS , PAVER-CP-MT , FG-LAVA-50
FPB-34DTMSIN-PK	TMSI	FPB-34DBTMSI-N , FLEXFRAME-SS3 , PAVER-VENT-4LNTS , PAVER-CP-TMSI , FG-LAVA-50
FPB-34D31MTN-PK***	MT	FPB-34DBS31MT-N , FLEXFRAME-SS3 , PAVER-VENT-4LNTS , PAVER-CP-MT , FG-LAVA-50

SQUARE FLAT SRW KIT PACKAGES

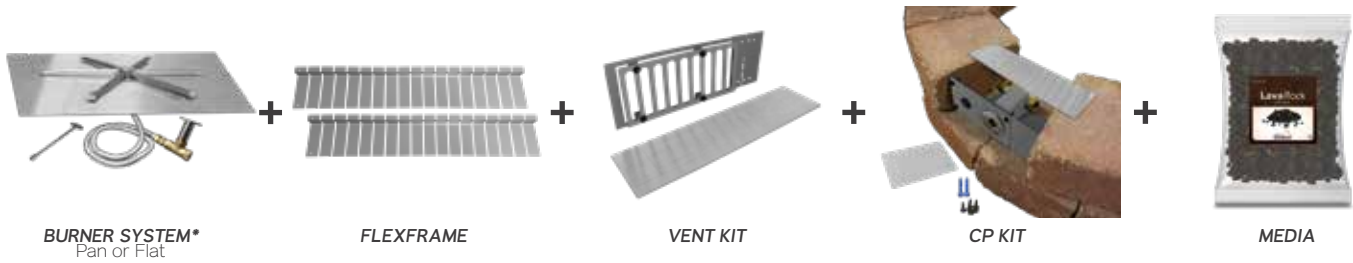

MODEL	IGNITION	PACKAGE INCLUDES
FPB-30SFMTN-PK	MT	FPB-30SFBSTMSI-N , FLEXFRAME-SS , PAVER-VENT-4LNTS , PAVER-CP-MT , FG-LAVA-10 (3)
FPB-30SFTMSIN-PK	TMSI	FPB-30SFBSTMSI-N , FLEXFRAME-SS , PAVER-VENT-4LNTS , PAVER-CP-TMSI , FG-LAVA-10 (3)
FPB-30SFTFSN-PK*	TFS	FPB-30SFBSTFS-N , FLEXFRAME-SS , PAVER-VENT-4LNTS , FG-LAVA-10 (3)

LINEAR SRW KIT PACKAGES

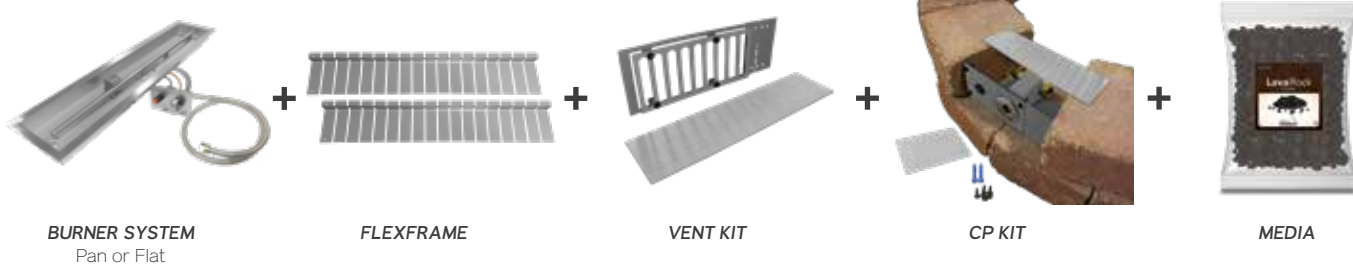

MODEL	IGNITION	PACKAGE INCLUDES
FPB-30LMTN-PK	MT	FPB-30LMT-N , FLEXFRAME-SS , PAVER-VENT-4LNTS , PAVER-CP-MT , FG-LAVA-10 (2)
LOF-36LTTMSIN-PK**	TMSI	LOF-36LTTMSI-N* , FLEXFRAME-SS , PAVER-VENT-4LNTS , PAVER-CP-TMSI , FG-LAVA-10 (2)
LOF-36LHTMSIN-PK**	TMSI	LOF-36LHTMSI-N* , FLEXFRAME-SS , PAVER-VENT-4LNTS , PAVER-CP-TMSI , FG-LAVA-10 (2)
FPB-36LTFSN-PK*	TFS	FPB-36LTFS-N , FLEXFRAME-SS , PAVER-VENT-4LNTS , FG-LAVA-10 (2)

SRW / ARCHITECTURAL BLOCK CONTROL PANELS

..... SEGMENTED RETAINING WALL

PAVER-CP-MT

For use when building fire pit enclosures with SRW block and Match Throw "MT" Burner Systems.

Key Valve Kit included as part of the Burner System.

Includes:

- Face Plate for Key Valve with Rubber Plug for MSI hole
- SRW Kit Bracket and Extender
- Lintel - 12' L x 3' W (20 gauge galvanized steel)
- Screws
- Fittings
- Tapcon® concrete anchors.

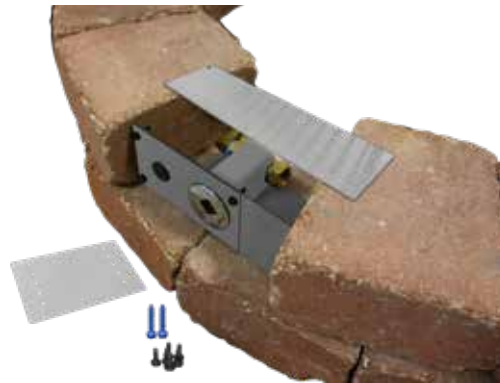

PAVER-CP-MT-MSI

For use when building fire pit enclosures with SRW block and Match Throw "MT" Burner Systems.

Key Valve Kit included as part of Burner System.

Includes:

- Face plate for Key Valve and MSI
- SRW Kit Bracket and Extender
- Lintel - 12' L x 3' W (20 gauge galvanized steel)
- Screws
- Battery Operated Piezo Igniter Assembly
- 48" Ignition Wire and a AAA battery
- Ignition Hood
- Screen
- Fittings
- Tapcon® concrete anchors.



PAVER-CP-TMSI

For use when building fire pit enclosures with SRW block and Thermocouple Manual Safety "TMSI" Burner Systems.

TMSI Valve Kit and Face Plate included as part of the Burner System.

Includes:

- SRW Kit Bracket and Extender
- Lintel - 12' L x 3' W (20 gauge galvanized steel)
- Screws
- Fittings
- Tapcon® concrete anchors.



ESTOP-CP-KIT

For use when building fire pit enclosures with SRW block and Firegear's E-Stop.

E-Stop sold separately.

Includes:

- Face plate
- SRW Kit Bracket and Extender
- Lintel - 12' L x 3' W (20 gauge galvanized steel)
- Screws
- Fittings, Tapcon® concrete anchors.



Dimensions of All Kits:

- Fully Extended: 7 1/8" H x 12' W
- Smallest Extension: 7 1/8" H x 8 1/2' W
- No Extension: 7 1/8" H x 8' W

FLEXFRAME

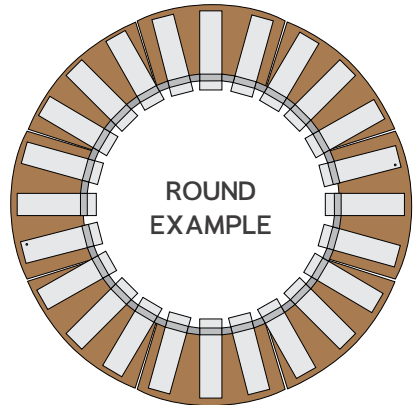
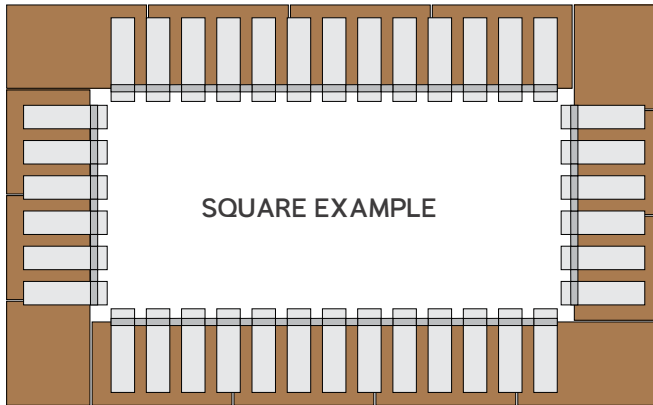

FLEXFRAME-SS

Constructed of 16 Gauge 304 Stainless Steel.

Provides additional protection against outdoor elements including salt water environments - two (2) 44' pieces per package.

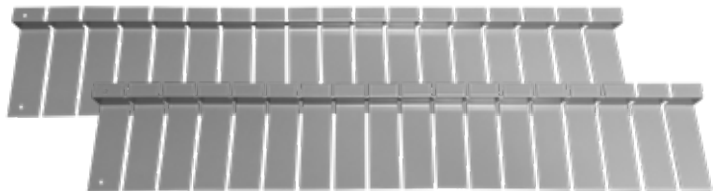

FLEXFRAME-SS3

Constructed of 16 Gauge 304 Stainless Steel.

Provides additional protection against outdoor elements including salt water environments - three (3) 44' pieces per package.

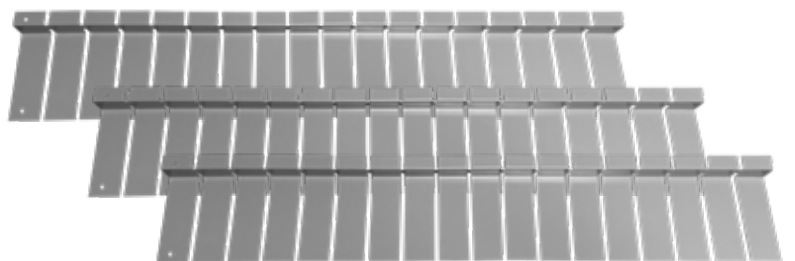

VENT KITS

PAVER-VENT-4-LNTS

Stainless Steel SRW Vent Kit with Lintel

Includes:

Two (2) 3 5/8" H x 8" W vents with mounting plate, extension plate extends overall size up to 10" W

Two (2) Tapcon® concrete anchors

Two (2) Lintels 12" L x 3" W (20 gauge galvanized steel)

Each vent provides 18 square inches of ventilation.



PAVER-VENT-6-LNTS

Stainless Steel SRW Vent Kit with Lintel

Includes:

Two (2) 5 5/8" H x 8" W vents with mounting plate, extension plate extends overall size up to 10" W

Two (2) Tapcon® concrete anchors

Two (2) Lintels 12" L x 3" W (20 gauge galvanized steel)

Each vent provides 18 square inches of ventilation.



Vent Kit Installed



WARNING - PROPOSITION 65

This product is designed to operate with one of the following fuel sources: Liquid Propane or Natural Gas. The fuel used to operate this product, and the products of combustion of such fuel, can expose you to chemicals including Benzene which is known to the State of California to cause cancer, birth defects and other reproductive harm and Carbon Monoxide which is known to the State of California to cause birth defects or other reproductive harm. (For more information go to: www.p65Warnings.ca.gov.)

JEWELRY



WARNING - PROPOSITION 65

This product is designed to operate with one of the following fuel sources: Liquid Propane or Natural Gas. The fuel used to operate this product, and the products of combustion of such fuel, can expose you to chemicals including Benzene which is known to the State of California to cause cancer, birth defects and other reproductive harm and Carbon Monoxide which is known to the State of California to cause birth defects or other reproductive harm. (For more information go to: www.p65Warnings.ca.gov.)



GRL-BLACK
LARGE REFLECTIVE GLASS

MEDIA



LAVA ROCK (FG-LAVA-10 / FG-LAVA-50)

Mined from the earth, these dark rocks contrast beautifully against a bright flame. Each rock is approximately 1" to 2" in diameter.



50 & 10 lb bag

Sold in approximately one (1) cubic foot bags



LAVA STONE (FG-LS50)

Made from tumbled lava rock, these stones lend a casual elegance. Each stone is approximately 1" to 2" in diameter.



50 lb bag



LAVA BOULDER (FG-LB30)

These rugged rocks are 6" to 12" in diameter, for a coastal, straight-off-the-beach style.



30 lb box

GLASS

BROKEN | Approximately 1/2" to 3/4" in size



PEPPER
GL-BLACK



BLUEBERRY
GL-DARK BLUE



SEABREEZE
GL-SEABREEZE



CRYSTAL
GL-CRYSTAL



CARIBBEAN
GL-LIGHTBLUE



COLA
GL-COPPER

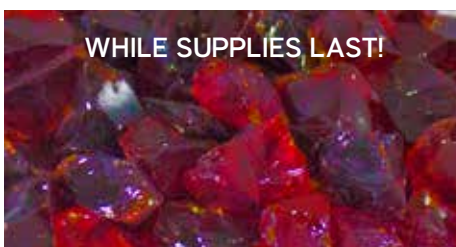

COSMO
GL-RED



All glass is sold in 5 lb. bags.
There are 8 bags per case.



Case pricing available.
Eight (8) 5lb. bags.

BEAD | Approximately 16 - 18mm in size



COBALT
GB-COBALT



H2O
GB-CLEAR



MIDNIGHT
GB-BLACK



SKY
GB-LT BLUE



TEQUILA
GB-GOLD



WHITE
GB-WHITE

LARGE REFLECTIVE | Mirror finish broken reflective, approximately 1/2" to 3/4" in size



EBONY
GRL-BLACK



BRONZE
GRL-BRONZE



COBALT
GRL-COBALT

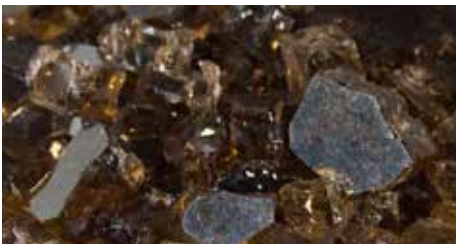

COPPER
GRL-COPPER



TAHITI
GRL-TAHITI

SMALL REFLECTIVE | Mirror finish broken reflective, approximately 1/4" to 3/8" in size



PLATINUM*
GR-PLAT

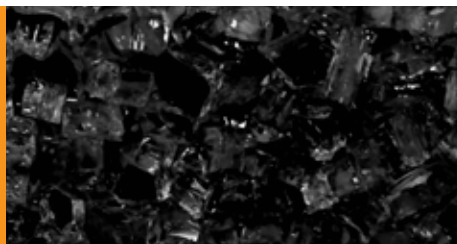

BLACK*
GR-BLACK

*While supplies last

LOG SETS

SPIT FIRE | L-SF

This seventeen (17) piece refractory log set is a great alternative to enjoy your fire feature without the mess of real wood and ashes.

Compatible with pits larger than 19"

Refractory concrete material

Ships as one (1) box, weighs approx 52 lbs.

Five (5) Year Limited Warranty



*Lava rock not included

BEACH FIRE | L-BF

The modest version of the Spit Fire, this eight (8) piece set is designed for smaller fire pit burners or used as an accent piece on larger burners.

Compatible with pits smaller than 20"

Refractory concrete material

Ships as one (1) box, weighs approx 20 lbs.

Five (5) Year Limited Warranty



*Lava rock not included

SEDONA | L-SEDONA

The Sedona is the Grand Daddy of all the Firegear log sets. This nineteen (19) piece majestic fire pit log set can stack as high as 32'.

Compatible with pits larger than 25"

Refractory concrete material

Ships as one (3) boxes, weighs approx 200 lbs., ships LTL

Five (5) Year Limited Warranty



*Lava rock not included

DRIFTWOOD TWIGS | 326-930

Beach washed and twisted driftwood twigs inspired this design. The coloration in this six (6) piece log set is truly unique.

Compatible with any size fire pit

Ceramic fiber composition

Ships as one (1) box, weighs approx 22 lbs.

One (1) Year Limited Warranty



*Lava rock not included

HOW MUCH MEDIA SHOULD I USE?

ROUND FIRE PITS

INSIDE DIAMETER OF FIRE PIT	LAVA ROCK ONLY	LAVA ROCK AS A BASE	GLASS ON TOP OF LAVA ROCK	LAVA STONES ON TOP OF LAVA ROCK	LAVA BOULDERS ON TOP OF LAVA ROCK
16"	10 lbs	5 lbs	10 lbs	10 lbs	1/4 box
19"	10 lbs	10 lbs	20 lbs	15 lbs	1/2 box
25"	15 lbs	15 lbs	30 lbs	20 lbs	3/4 box
29"	20 lbs	20 lbs	40 lbs	25 lbs	1 box
33"	25 lbs	25 lbs	50 lbs	30 lbs	1 box
34"	30 lbs	25 lbs	60 lbs	30 lbs	1 box
44"	45 lbs	35 lbs	70 lbs	50 lbs	2-3 boxes

SQUARE FIRE PITS

INSIDE DIAMETER OF FIRE PIT	LAVA ROCK ONLY	LAVA ROCK AS A BASE	GLASS ON TOP OF LAVA ROCK	LAVA STONES ON TOP OF LAVA ROCK	LAVA BOULDERS ON TOP OF LAVA ROCK
20"	10 lbs	10 lbs	20 lbs	15 lbs	1/2 box
26"	15 lbs	15 lbs	30 lbs	20 lbs	3/4 box
32"	25 lbs	25 lbs	50 lbs	30 lbs	1 box
38"	30 lbs	30 lbs	60 lbs	35 lbs	1 1/4 boxes

L-SERIES FIRE PITS

MODEL	LAVA ROCK ONLY	GLASS ONLY	LAVA STONES ONLY
FPB-24L	10 lbs	10 lbs	6 lbs
FPB-30L	10 lbs	13 lbs	10 lbs
FPB-36L	15 lbs	15 lbs	12 lbs
FPB-24L + FPB-24L	16 lbs	20 lbs	16 lbs
FPB-24L + FPB-30L	18 lbs	23 lbs	18 lbs
FPB-30L + FPB-30L	20 lbs	26 lbs	20 lbs
FPB-30L + FPB-36L	22 lbs	28 lbs	22 lbs
FPB-36L + FPB-36L	24 lbs	30 lbs	24 lbs

LOF (LINE OF FIRE) FIRE PITS

MODEL	LAVA ROCK ONLY	GLASS ONLY	LAVA STONES ONLY
LOF-30LHTMSI-N	20 lbs	25 lbs	20 lbs
LOF-36LHTMSI-N	25 lbs	35 lbs	25 lbs
LOF-48LHTMSI-N	35 lbs	55 lbs	35 lbs
LOF-30LTTMSI-N	10 lbs	20 lbs	10 lbs
LOF-36LTTMSI-N	15 lbs	25 lbs	15 lbs
LOF-48LTTMSI-N	20 lbs	30 lbs	20 lbs
LOF-60LTTMSI-N	25 lbs	40 lbs	25 lbs

LAVA ROCK ONLY

When using lava rock, use enough to cover entire burner. Do not over-fill. Just use enough to hide the burner from view.



LAVA ROCK & GLASS

In order to use glass, you must lay down a layer of lava rock. Fill the pan with lava rock until it is level with the top of the burner. Then take your glass and lay it on top of the lava rock and burner. The glass should only be 3/4" to 1" thick, or just enough to cover the burner.

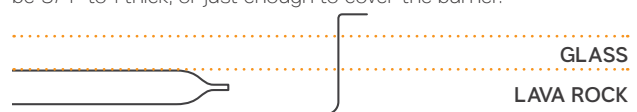

LAVA ROCK & LAVA STONES

In order to use lava stones, you must lay down a layer of lava rock. Fill the pan with lava rock until it is level with the top of the burner. Then take your lava stones and lay it on top of the lava rock and burner. The lava stones should only be one layer thick, just enough to cover the burner.



LAVA ROCK & LAVA BOULDERS

In order to use lava boulders, you must lay down a bottom layer of lava rock. Fill the pan with lava rock until it is level with the top of the burner. Then take your lava boulders and lay it on top of the lava rock and burner. Lava boulders are 6" to 12" in diameter.

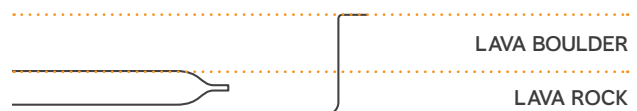

ACCESSORIES



WARNING - PROPOSITION 65

This product is designed to operate with one of the following fuel sources: Liquid Propane or Natural Gas. The fuel used to operate this product, and the products of combustion of such fuel, can expose you to chemicals including Benzene which is known to the State of California to cause cancer, birth defects and other reproductive harm and Carbon Monoxide which is known to the State of California to cause birth defects or other reproductive harm. (For more information go to: www.p65Warnings.ca.gov.)



Burner System: LOF-36LTMSI-N / Windshield: GWS-6010

Firegear Outdoors featuring Unilock

UNILOCK
PAVERS & WALLS

E-STOP GAS TIMER



COMPLETELY MECHANICAL NO POWER REQUIRED!

FEATURES

- Unique all mechanical gas shut-off timer with built-in emergency stop - no power required
- High Btu capacity
- Safest gas timer available in the industry
- Available in 2.5 and 1 hour models
- Innovative multi-port design provides installation flexibility
- 1/2" NPT inlets and outlets (side and back)
- Six (6) mounting holes (front and side) for secure installation
- Natural gas (NG) or Liquid Propane (LP) - no conversion necessary
- Dial has UV Protection



MODELS



ESTOP1-0H

Mechanical timer with manual emergency shut-off. 1 hour countdown timer.



ESTOP2-5H

Mechanical timer with manual emergency shut-off. 2.5 hour countdown timer.

MOUNTING & ENCLOSURES

[E-STOP SOLD SEPARATELY]

ESTOP-LC-KIT

Locking cabinet. Constructed of 304 stainless steel. Removable lock.

 REPRESENTS MOUNTING MATERIAL

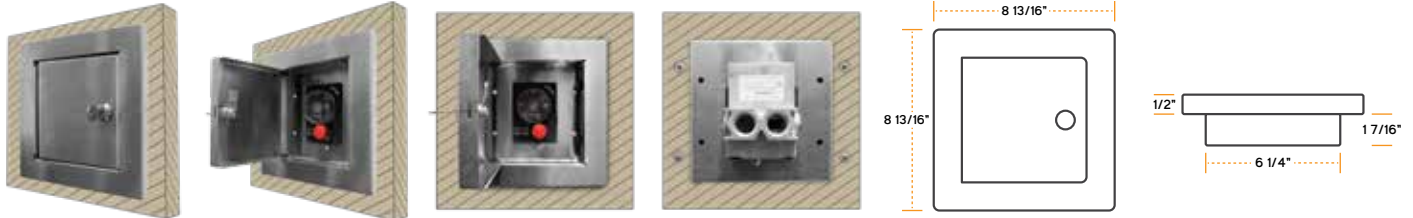

ESTOP-RM-KIT

Surface mount for the E-Stop. Constructed of 304 stainless steel.



ESTOP-CP-KIT

Designed for use with architectural block / pavers. Expands from 8" to 12" wide to accommodate various block sizes.



SPECIFICATIONS

TYPICAL MAXIMUM CAPACITY IS BASED ON:

Nominal pressure supplied to inlet of E-Stop Timer while appliances are in-operation

NG: 7.0-Inches-H2O

LP: 11.0-Inches-H2O

Minimum rated appliance inlet pressure

NG: 3.5-Inches-H2O

LP: 8.0-Inches-H2O

TYPICAL MAXIMUM CAPACITY

Natural Gas: 290,000 BTU/hr

Liquid Propane Gas: 430,000 BTU/hr

CSA RATED CAPACITY AT 1-INCH-H2O PRESSURE DROP

165,000 BTU/hr

WARNING - PROPOSITION 65

This product is designed to operate with one of the following fuel sources: Liquid Propane or Natural Gas. The fuel used to operate this product, and the products of combustion of such fuel, can expose you to chemicals including Benzene which is known to the State of California to cause cancer, birth defects and other reproductive harm and Carbon Monoxide which is known to the State of California to cause birth defects or other reproductive harm. (For more information go to: www.p65Warnings.ca.gov.)

CONTROLS

For use with: Ecoflow & Thermocouple Flame Sense



TM-R-AF1TX **TFS**
Wireless Wall Timer (30min/60min/120min), twenty (20) foot range, surface mount, battery operated, uses two 3-volt button cell batteries (included) - (TFS units only)



1322WT **TFS**
Wireless Wall Mount On/Off/High/Low Transmitter, twenty (20) foot range, surface mount, battery operated, uses two 3-volt button cell batteries (included) - (TFS units only)



1001D-AF1TX **TFS**
Wireless wall mount switch (On/Off), twenty (20) foot range, surface mount, battery operated, uses two 3-volt button cell batteries (included) - (TFS units only)



WS **TFS**
Wired wall mount switch (On/Off) with twenty (20) foot of low voltage wire



RCAF-3TX **TFS**
3-Step battery-operated remote control to power an ON/OFF internal solenoid, twenty (20) foot range



ADP10-OUT **TFS**
Outdoor 7.5 Vdc power adapter, 10 feet in length



ADP70-OUT **TFS**
Outdoor 7.5 Vdc power adapter, 70 feet in length



AF-4000HAT **TFS**
Pool/Home Automation System Link (works with most manufacturers systems)

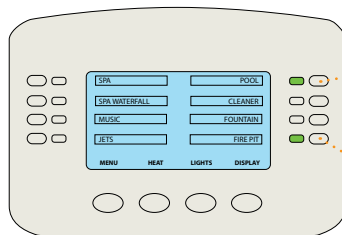

POOL/HOME SYSTEM

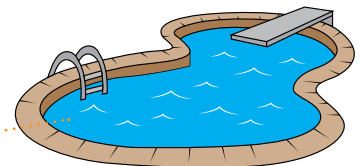

POOL



AF-4000HAT



FIRE FEATURE

VENT KIT

VENT-KIT-6X12SS

Includes two (2) Stainless Steel 6" H x 12" W vents with mounting screws. Each vent provides 18 square inches of ventilation.



No cutting, no guessing, no hassles – no problem®
necessaries™
kits for outdoor living

ROCKWOOD
RETAINING WALLS
A better way.™

WINDSHIELDS

ROUND WINDSHIELDS

Heavy duty 1/4" heat resistant tempered glass with pencil grind satin edges
Zinc die casted, plated polished chrome hardware with silicone rubber feet

MODEL	SIZE	DESIGNED TO FIT
GWS-22R	22.9" Diameter	FPB-16R / FPB-19R

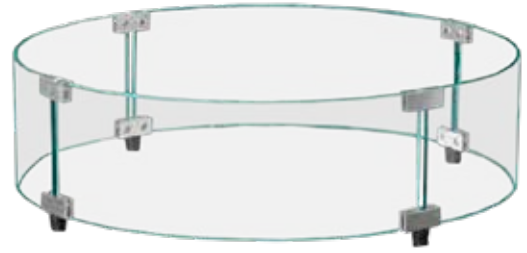

SQUARE WINDSHIELDS

Heavy duty 1/4" heat resistant tempered glass with pencil grind satin edges
Zinc die casted, plated polished chrome hardware with silicone rubber feet

MODEL	SIZE	DESIGNED TO FIT	GLASS PIECES
GWS-2424	24" x 24" L x 7 1/2" H	FPB-20S Square Burner	4
GWS-3838*	38" x 38" L x 7 1/2" H	FPB-32S Square Burner	4
GWS-4242*	42" x 42" L x 7 1/2" H	FPB-38S Square Burner	4

*While supplies last



LINEAR WINDSHIELDS

Heavy duty 1/4" heat resistant tempered glass with pencil grind satin edges
Zinc die casted, plated polished chrome hardware with silicone rubber feet

MODEL	SIZE	DESIGNED TO FIT
GWS-3810	38" L x 10" W x 7 1/2" H	FPB-24L / LOF-30LT
GWS-4410	44" L x 10" W x 7 1/2" H	FPB-30L / LOF-36LT
GWS-6010	60" L x 10" W x 7 1/2" H	FPB-24L + FPB-24L FPB-30L + FPB-24L LOF-48LT
GWS-8410	84" L x 10" W x 7 1/2" H	FPB-30L + FPB-30L FPB-36L + FPB-30L FPB-36L + FPB-36L LOF-60LT

GWS-6010: What's in this?

Four (4) 30" L x 7 1/2" T pieces
Two (2) 10" L x 7 1/2" T pieces

GWS-8410: What's in this?

Four (4) 42" L x 7 1/2" T pieces
Two (2) 10" L x 7 1/2" T pieces

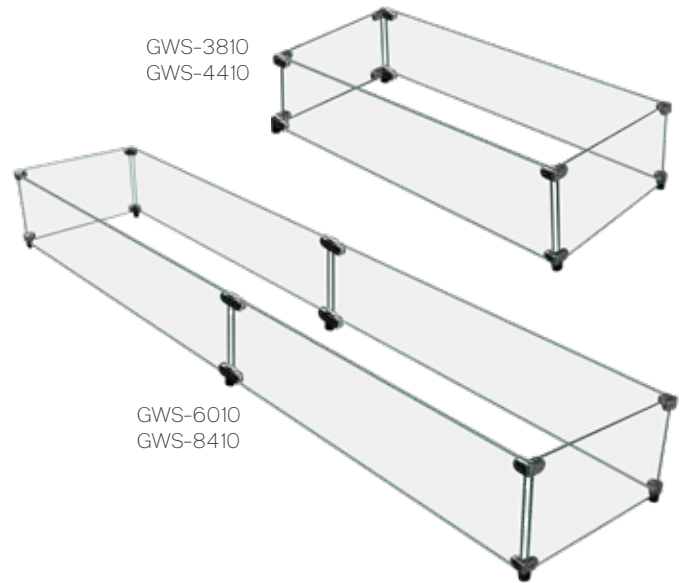

HARDWARE PACKAGES

MODEL	AMOUNT	DESIGNED TO FIT
GWS-BRACKET-S	Set of 4	All Square & Linear Windshields
GWS-STRAIGHTBRKT	Set of 4	All Linear Windshields



GWS-BRACKET-S



GWS-STRAIGHTBRKT

LIDS

ROUND LIDS

MODEL	DIMENSIONS	DESIGNED TO FIT
LID-16R	19" Diameter x 5/8" H - lid height with handle 2"	FPB-16R
LID-19R	22 3/8" Diameter x 5/8" H - lid height with handle 2"	FPB-19R Series
LID-25R	28 3/8" Diameter x 5/8" H - lid height with handle 2"	FPB-25R Series
LID-29R2*	32" Diameter x 1 1/8" H - lid height with handle 2.5"	FPB-29R Series
LID-33R2*	36" Diameter x 1 1/8" H - lid height with handle 2.5"	FPB-33R Series

*New style flat lid with placement tabs

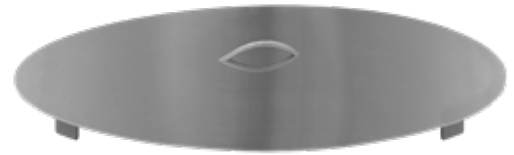

SQUARE LIDS

MODEL	DIMENSIONS	DESIGNED TO FIT
LID-20S	22 1/4" W x 5/8" H - lid height with handle 2"	FPB-20S Series
LID-26S*	28 1/4" W x 5/8" H - lid height with handle 2"	FPB-26S Series
LID-32S*	34 1/4" W x 5/8" H - lid height with handle 2"	FPB-32S Series
LID-38S*	40 1/4" W x 5/8" H - lid height with handle 2"	FPB-38S Series

*While supplies last

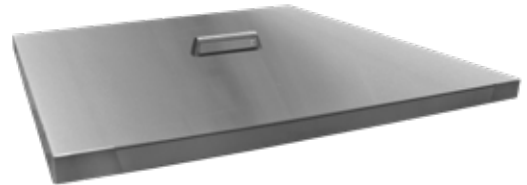

L-SERIES LIDS

MODEL	DIMENSIONS	DESIGNED TO FIT
LID-24L	29 1/4" L x 8 1/4" W x 2 5/8" H (with handle)	FPB-24L
LID-30L	35 3/4" L x 8 1/4" W x 2 5/8" H (with handle)	FPB-30L
LID-36L	41 3/4" L x 8 1/4" W x 2 5/8" H (with handle)	FPB-36L
LID-60L	53 3/4" L x 8 1/4" W x 2 5/8" H (with handle)	FPB-24L + FPB-24L
LID-68L	69 3/4" L x 8 1/4" W x 2 5/8" H (with handle)	FPB-30L + FPB-30L
LID-84L	77 3/4" L x 8 1/4" W x 2 5/8" H (with handle)	FPB-36L + FPB-36L

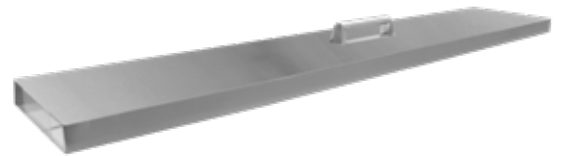

LINE OF FIRE LIDS

MODEL	DIMENSIONS	DESIGNED TO FIT
LID-LOF30LT	32 3/4" L x 8 3/4" W x 2 7/8" H (with handle)	LOF-30LT
LID-LOF36LT	38 3/4" L x 8 3/4" W x 2 7/8" H (with handle)	LOF-36LT
LID-LOF48LT	50 3/4" L x 8 3/4" W x 2 7/8" H (with handle)	LOF-48LT
LID-LOF60LT	62 3/4" L x 8 3/4" W x 2 7/8" H (with handle)	LOF-60LT
LID-LOF30LH	32 3/4" L x 12 3/4" W x 2 7/8" H (with handle)	LOF-30LH
LID-LOF36LH	38 3/4" L x 14 3/4" W x 2 7/8" H (with handle)	LOF-36LH
LID-LOF48LH	50 3/4" L x 16 3/4" W x 2 7/8" H (with handle)	LOF-48LH

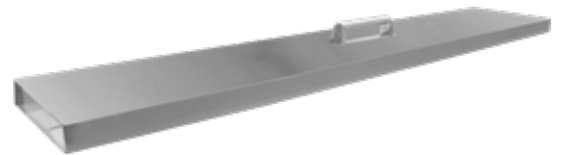

HOSES & REGULATORS

FG-LPQDK

Liquid propane quick disconnect kit - includes: 12' (144"), 1/2" OD, 3/8" ID, gray PVC hose with quick disconnect fitting and socket dust cap, FG-LPRK liquid propane regulator, 3/8" MPT Adapter and ACME quick connect. CSA-AGA/CGA approved, rated at 80,000 BTU



FG-12QDK

Quick Disconnect Kit for use with Natural Gas or Liquid Propane - 12' (144"), 1/2" OD, 3/8" ID, Gray PVC Hose, Quick Disconnect Fitting and Socket Dust Cap, 80,000 Btu. CSA-AGA/CGA approved to -40 Degrees F



FG-LPRK

Rated at 100,000 Btu Liquid Propane Regulator, 3/8" MPT Adapter and Acme Quick Connect. CSA-AGA/CGA approved



FG-32LPHRK

32" Liquid Propane Hose and Regulator Kit, Rated at 85,375 Btu 10" WC. CSA - AGA / CGA Approved, 3/8" Flared ID

FG-60LPHRK

32" Liquid Propane Hose and Regulator Kit, Rated at 130,000 Btu 10" WC. CSA - AGA / CGA Approved, 3/8" Flared ID



WARNING - PROPOSITION 65

This product is designed to operate with one of the following fuel sources: Liquid Propane or Natural Gas. The fuel used to operate this product, and the products of combustion of such fuel, can expose you to chemicals including Benzene which is known to the State of California to cause cancer, birth defects and other reproductive harm and Carbon Monoxide which is known to the State of California to cause birth defects or other reproductive harm. (For more information go to: www.p65Warnings.ca.gov)

VALVES



ESTOP1-0H

Mechanical timer with manual emergency shut-off. 1 hour countdown timer.



ESTOP2-5H

Mechanical timer with manual emergency shut-off. 2.5 hour countdown timer.



KV-PC-12

High Capacity Straight Key Valve with Polished Chrome Cover and 12" Key, 350,000 Btu @1/2 PSI

REPLACES:
KVSC-PC-12 & KVHC-PC-12



KEY-PC-12

12" Polished Chrome Key for Key Valve



01-387

Connector Ball Valve
3/8" OD Flare x 1/2" FIP



01-487

Connector Ball Valve
1/2" OD Flare x 1/2" FIP



01-266

Flare Ball Valve
3/8" OD Flare x 3/8" OD Flare



01-288

Flare Ball Valve
1/2" OD Flare x 1/2" OD Flare

FITTINGS



U1-6C-S (steel)

3/8" OD FLARE X 3/8" MIP (TAPPED 1/8" FIP)



U1-6D-S (steel)

3/8" OD FLARE X 1/2" MIP (TAPPED 3/8" FIP)



U3-6D-S (brass)

3/8" OD FLARE X 1/2" FIP



50-66 (brass)

3/8" OD FLARE X 3/8" FIP ELBOW



50-68 (brass)

3/8" OD FLARE X 1/2" FIP ELBOW



U1-8C-S (steel)

1/2" OD FLARE X 3/8" MIP (TAPPED 1/4" FIP)



U1-8D-S (steel)

1/2" OD FLARE X 1/2" MIP (TAPPED 3/8" FIP)



U3-8D-S (steel)

1/2" OD FLARE X 1/2" FIP



50-88 (brass)

1/2" OD FLARE X 1/2" FIP ELBOW

FLEX LINES

T100 SERIES



MODEL	DESCRIPTION
T100-9898-10	3/8" OD (1/4" ID) x 10', with 3/8" OD flare nuts
T100-9898-16	3/8" OD (1/4" ID) x 16', with 3/8" OD flare nuts
T100-9898-22	3/8" OD (1/4" ID) x 22', with 3/8" OD flare nuts
T100-9898-28	3/8" OD (1/4" ID) x 28', with 3/8" OD flare nuts
T100-9898-34	3/8" OD (1/4" ID) x 34', with 3/8" OD flare nuts

T102 SERIES



MODEL	DESCRIPTION
T102-9898-10	3/8" OD (1/4" ID) x 10', with 3/8" OD flare nuts
T102-9898-16	3/8" OD (1/4" ID) x 16', with 3/8" OD flare nuts
T102-9898-22	3/8" OD (1/4" ID) x 22', with 3/8" OD flare nuts
T102-9898-28	3/8" OD (1/4" ID) x 28', with 3/8" OD flare nuts
T102-9898-34	3/8" OD (1/4" ID) x 34', with 3/8" OD flare nuts

T200 SERIES



MODEL	DESCRIPTION
T200-9898-10	1/2" OD (3/8" ID) x 10', with 1/2" OD flare nuts
T200-9898-16	1/2" OD (3/8" ID) x 16', with 1/2" OD flare nuts
T200-9898-22	1/2" OD (3/8" ID) x 22', with 1/2" OD flare nuts
T200-9898-28	1/2" OD (3/8" ID) x 28', with 1/2" OD flare nuts
T200-9898-34	1/2" OD (3/8" ID) x 34', with 1/2" OD flare nuts
T200-9898-46	1/2" OD (3/8" ID) x 46', with 1/2" OD flare nuts

T202 SERIES



MODEL	DESCRIPTION
T202-9898-10	1/2" OD (3/8" ID) x 10', with 1/2" OD flare nuts
T202-9898-16	1/2" OD (3/8" ID) x 16', with 1/2" OD flare nuts
T202-9898-22	1/2" OD (3/8" ID) x 22', with 1/2" OD flare nuts
T202-9898-28	1/2" OD (3/8" ID) x 28', with 1/2" OD flare nuts
T202-9898-34	1/2" OD (3/8" ID) x 34', with 1/2" OD flare nuts

PANS

ROUND PAN

MODEL	THICKNESS	OUTSIDE DIM.	MIN/MAX CUT OUT	INSIDE PAN DIM.	OUTSIDE DIM.
PAN-SS16R	20 Gauge	18 1/2" including lip	16 1/2" - 17 1/4"	16"	2 1/2"
PAN-SS19R	16 Gauge	22" including lip	19 1/4" - 21 1/2"	19"	2 3/4"
PAN-SS25R	16 Gauge	28" including lip	25 1/4" - 27 1/2"	25"	2 3/4"
PAN-SS29R	16 Gauge	32 1/4" including lip	30" - 31 3/8"	29"	2 3/4"
PAN-SS33R	16 Gauge	36 1/4" including lip	34" - 35 1/4"	33"	2 3/4"

CENTER HOLE DIMENSION: 7/8"

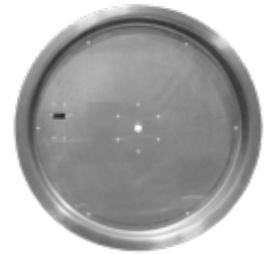

ROUND FLAT

MODEL	THICKNESS	OUTSIDE DIM.
PAN-SS19.75D*	16 Gauge	19 3/4"
PAN-SS29D	16 Gauge	29"
PAN-SS34D	16 Gauge	34"
PAN-SS44D	16 Gauge	44"

*While supplies last

CENTER HOLE DIMENSION: 7/8"

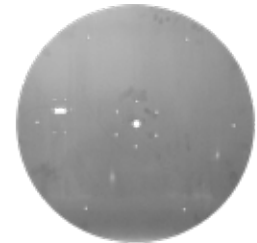

SQUARE PAN

MODEL	THICKNESS	OUTSIDE DIM.	MIN/MAX CUT OUT	INSIDE PAN DIM.	OUTSIDE DIM.
PAN-SS20S	16 Gauge	22" x 22"	20 1/4" - 21 3/4"	20"	2 1/2"

CENTER HOLE DIMENSION: 7/8"

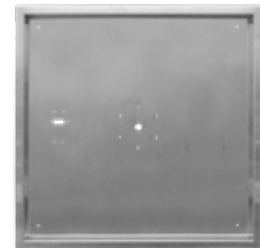

SQUARE FLAT

MODEL	THICKNESS	OUTSIDE DIM.
PAN-SS25SF	16 Gauge	25" x 25"
PAN-SS30SF	16 Gauge	30" x 30"
PAN-SS34SF	16 Gauge	34" x 34"
PAN-SS40SF	16 Gauge	40" x 40"
PAN-SS46SF*	16 Gauge	46" x 46"

*While supplies last

CENTER HOLE DIMENSION: 7/8"

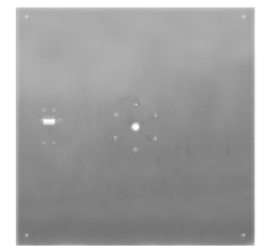

LINEAR PAN

MODEL	THICKNESS	OUTSIDE DIM.	MIN/MAX CUT OUT	INSIDE PAN DIM.	OUTSIDE DIM.
PAN-SS3010L	19 Gauge	32 1/2" x 12 1/2"	30 1/2" - 12 1/4"	30" x 10"	2 1/2"
PAN-SS3612L	19 Gauge	38 1/2" x 14 1/2"	36 1/2" - 14 1/4"	36" x 12"	2 1/2"
PAN-SS4814L	19 Gauge	50 1/2" x 16 1/2"	48 1/2" - 16 1/4"	48" x 14"	2 1/2"
PAN-SS3006L	19 Gauge	32 1/2" x 8 1/2"	30 1/2" - 8 1/4"	30" x 6"	2 1/2"
PAN-SS3606L	19 Gauge	38 1/2" x 8 1/2"	36 1/2" - 8 1/4"	36" x 6"	2 1/2"
PAN-SS4806L	19 Gauge	50 1/2" x 8 1/2"	48 1/2" - 8 1/4"	48" x 6"	2 1/2"
PAN-SS6006L	19 Gauge	62 1/2" x 8 1/2"	60 1/2" - 8 1/4"	60" x 6"	2 1/2"

CENTER HOLE DIMENSION: 7/8"



REPLACEMENT PARTS

ROUND / SQUARE / FLAT: TFS REPLACEMENT PARTS



AF-4025DSILSS0
Electronic IPI gas valve with solenoid



RCAF-3TXUNF
ON/OFF/Hi/LO transmitter



VCS-5000MODTC
Ignition module



AF-4000BP12
Battery pack (with 12ft 4-pin, 4-wire harness, cover plate and 12ft red & black 2-wire harness for solenoid)



TFS-IGNT-ASSEMBLY
Ignition module, igniter probes, thermocouple, and ignition hood

L-SERIES: TFS REPLACEMENT PARTS



AF-4025DSILSS36
Electronic IPI gas valve with solenoid



VCS-5000MODTC
Ignition module



AF-4000BP12
Battery pack (with 12ft 4-pin, 4-wire harness, cover plate and 12ft red & black 2-wire harness for solenoid)



RCAF-3TXUNF
ON/OFF HI/LO transmitter



PILOTSHIELD-L
Linear burner pilot cover



PILOTCOVER-L
Linear burner pilot shield



PILOTO-23300-206
Pilot assembly



WARNING - PROPOSITION 65

This product is designed to operate with one of the following fuel sources: Liquid Propane or Natural Gas. The fuel used to operate this product, and the products of combustion of such fuel, can expose you to chemicals including Benzene which is known to the State of California to cause cancer, birth defects and other reproductive harm and Carbon Monoxide which is known to the State of California to cause birth defects or other reproductive harm. (For more information go to: www.p65Warnings.ca.gov.)

REPLACEMENT PARTS

ROUND / SQUARE / FLAT: TMSI REPLACEMENT PARTS



ST3-080-1009

Copreci manual gas valve



ST3-050-1024

Manual gas valve knob for Copreci valve



TMS-TC-ASSEMBLY

Copreci thermocouple with ignition hood for non-piloted TMS systems

LINE OF FIRE: TMSI REPLACEMENT PARTS



FG-CONTROL-FP

Faceplate for TMSI line of fire systems



FG-GASVALVE-1

Gas valve - Non Piloted TMSI version



FG-GASVALVE-2

Gas valve - Piloted TMSI version



FG-CONTROL-KNOB

Control knob for TMSI line of fire systems



FG-SPARK-IGN

Spark igniter



FG-IGNITION-HOOD

Ignition hood for piloted and non-piloted systems



FG-IGNIT-ASSY-PI

Ignition assembly for piloted systems



FG-IGNITOR-WIRE

Ignition wire for non-piloted systems



FG-THERMOCOUPLE

Thermocouple for non-piloted systems

DEALER TOOLS



DIMENSIONS: 75" Tall x 22" Wide

FG-KIOSK-KIT

The Firegear three-sided spinning kiosk provides a step-by-step guide on how to select the proper components to build a fire pit.

Includes: FG-KIOSK-OUTDOOR / DBS-22 / KIOSK-FPB-20D / KIOSK-FPB-20TMS / FPB-30LTFS / KIOSK-GLASS-JARS



DIMENSIONS: 64" H x 26" W x 17" D

FG-JEWELRY-POP-2

A retail point of purchase display for all of the glass that Firegear has to offer. The POP display holds up to thirty-seven (37) bags of glass.

Limit one per location.

Includes GL-GLASSTOWER



FG-AD-BANNER

Firegear authorized dealer banner. 2 feet high x 4 feet long.



GL-SAMPLE-KIT

Twenty (20) different types of glass including large fireglass, beaded, reflective, lava stones and lava rock.



GL-GLASSTOWER

Spinning display with twenty (20) glass cylinders. 13 inches tall x 10 inches in diameter



BANNER UPS

Two different fabric banners. One for the Sanctuary Series, the other for a general product overview.



SAN-COLOR-SAMPLE

Sanctuary Sample Swatches

5 Colors: Raven (Black) - Slate (Grey) - Mocha (Brown) - Cream (Off White) - Arctic (White)

Size: 2 7/8" h x 2 7/8" w, 3/4" thick

APPAREL

CUSTOMIZE THESE APPAREL OPTIONS WITH **YOUR LOGO**



Firegear Letterman Jacket

We took the old-school letterman jacket and reworked it in comfortable wool-like polyester with a warm quilted lining. A detachable hood adds versatility (mens sizes only)

Special Order - Call for Details

Firegear Work Shirt

This shirt is ready for whatever the job throws at you. Moisture-wicking and with a stain-release finish, this versatile shirt is tested and approved for harsh work environments.

Special Order - Call for Details

GAS PIPE SIZING CHART

NATURAL GAS

PIPE LENGTH (feet)	1/2"	3/4"	1"	1 - 1/4"	1 - 1/2"	2"	2 - 2 1/2"	3"	4"
10	108	230	387	793	1237	2259	3640	6434	-
20	75	160	280	569	877	1610	2613	5236	9521
30	61	129	224	471	719	1335	2165	4107	7859
40	52	110	196	401	635	1143	1867	3258	6795
50	46	98	177	364	560	1041	1680	2936	6142
60	42	89	159	336	513	957	1559	2684	5647
70	38	82	149	317	476	896	1447	2492	5250
80	36	76	140	239	443	840	1353	2315	4900
90	33	71	133	275	420	793	1288	2203	4667
100	32	68	126	266	411	775	1246	2128	4518
125	28	60	117	243	369	700	1143	1904	4065
150	25	54	105	215	327	625	1008	1689	3645
175	23	50	93	196	303	583	993	1554	3370
200	22	47	84	182	280	541	877	1437	3160
300	17	37	70	145	224	439	686	1139	2539

Natural Gas (NG) flow is given in thousands of BTU/hr. One cubic foot of NG gas - 1000 BTU.

Nominal pressure at the burner for Natural Gas is 3.5" of water column. (Typical machine supply 5" - 7").

Pipe length must include additional length for all fittings. Add approximately 5 feet of pipe per fitting.

Natural Gas Example: A machine with a burner that requires 440,000 BTU would need a 1 - 1/4" pipe for a 20' long run.

LIQUID PROPANE

PIPE LENGTH (feet)	1/2"	3/4"	1"	1 - 1/4"	1 - 1/2"	2"	2 - 2 1/2"	3"	4"
10	275	567	1071	2205	3307	6221	10140	17990	35710
20	189	393	732	1496	2299	4331	7046	12510	25520
30	152	315	590	1212	1858	3465	5695	10110	20620
40	129	267	504	1039	1559	2992	4778	8481	17300
50	114	237	448	913	1417	2646	4343	7708	15730
60	103	217	409	834	1275	2394	3908	6936	14150
70	89	185	346	724	1086	2047	3329	5908	12050
80	78	162	307	630	976	1811	2991	5309	10830
90	69	146	275	567	866	1606	2654	4711	9613
100	63	132	252	511	787	1496	2412	4281	8736
125	54	112	209	439	665	1282	2083	3618	7382
150	48	100	185	390	590	1138	1808	3210	6549
175	43	90	168	353	534	1030	1637	2905	5927
200	40	83	155	325	491	947	1505	2671	5450
300	37	77	144	303	458	887	1404	2492	5084

Liquid Propane (LP) flow is given in thousands of BTU/hr. One cubic foot of NG gas - 2516 BTU.

This chart refers to low pressure LP, after regulation, standard nominal pressure at the burner for Liquid Propane Gas is 11" of water column

Pipe length must include additional length for all fittings. Add approximately 5 feet of pipe per fitting.

Liquid Propane Example: A machine with a burner that requires 440,000 BTU would need a 1" pipe for a 20' long run.

NOTE: The sizing charts above list the specific pipe sizes required for the amount of BTU's for a new gas line installations. If you are using an existing gas line you must take into consideration the existing gas line capacities to ensure you will have proper pressure.

This chart is for reference only, we recommend you consult with a Licensed Plumber/Gas Fitter or NFPA54 (National Fuel Gas Code - current edition) for more details.

PROPANE TANK BTU'S

11 lb. Tank	20 lb. Tank	30 lb. Tank	40 lb. Tank	50 lb. Tank
= 2.98 gal. of gas	= 5 gal. of gas	= 7 gal. of gas	= 10 gal. of gas	= 25 gal. of gas
= 256,205 BTU's	= 430,000 BTU's	= 640,000 BTU's	= 860,000 BTU's	= 2,159,400 BTU's

To determine how long a gas appliance will operate on one tank of gas first determined the total Btu's of the propane tank. Divide that number by the total Btu's of your appliance. This will provide to the approximate total time your gas appliance will operate on the tank of gas.

Example: I have a LP gas fire pit rated at 105,000 Btu's and I am considering using a 20lb. Propane tank to operate it. If you take 430,000 Btu's (total Btu's of a 20lb. tank) divided by 105,000 Btu's the total operating time will be approximate 4.09 hours.

REFERENCES

CAD DETAILS

Firegear has partnered with CADdetails to provide you free and easy access to CAD drawings in multiple CAD and BIM formats, specifications, 3D models, product brochures, video and related documents. To access the Firegear CADdetails files, visit our home page www.firegearoutdoors.com, click on the CADdetails logo and follow the registration process.

You can also go to www.firegearcad.com to quickly access our CAD Details page.

SPECIFICATION BOOK

Our catalog is a comprehensive list of all products we sell. We understand you may need more detailed information; including clearance to combustibles, product dimensions, etc. This information can be found on our website either in our Specification Book.

INSTALLATION MANUALS

If you need the installation manual for any Firegear product, they can be found on our website.



CUSTOM QUOTE REQUEST FORM

Estimated Lead Times:
Quotes: 2 - 3 business days
Orders: 2 - 3 weeks from date of order

Quote# _____ Request Date _____

CONTACT INFO

Distributor: _____ Contact: _____
Phone (Office): _____ Email: _____
Street Address: _____
City: _____ State: _____ Zip: _____

Re-Seller: _____ Contact: _____
Phone (Office): _____ Email: _____
Street Address: _____
City: _____ State: _____ Zip: _____

Project Name: _____
Expected N

**Download the Custom Quote Request Form at:
www.firegearoutdoors.com/customform**

PROJECT INFORMATION : Please answer / select all that apply

Project Application: Commercial Residential Estimated Length of Run for Gas Line _____
Gas Type: NG (Natural Gas) LP (Liquid Propane) Size of gas line _____

Please check which item best describes your project:

Complete custom fire feature (Includes Disc or Pan, Burner and Ignition System)
Custom Burner Only (No Pan, No Ignition System) Custom Pan Only
Can pan be shipped in segments? Yes No

IGNITION TYPE : How to turn it on - Check **one**

BTU set at 20,000 per linear foot. Example: A 4 foot burner would have an orifice rated at 80,000 BTU.
Hot Surface, Electronic Ignition (Requires 120Vac): 125,000 BTU 290,000 BTU 500,000 BTU
..... Choose One: 30Vdc or 24Vac
.....
Match Light (Light with Butane Lighter) (NOTE: Max BTU for match light is 65k BTU)

Ignition Accessories for Electronic Systems - Check all that apply

Mechanical Timer Emergency Shut Off Wall Switch On / Off Remote Control

Remote Control for Electronic Ignition Systems only (max distance is 25' from appliance)

ROUND & SQUARE PANS, DISC OR PLATES : (Flat or with Lip) Select or fill in where applicable

Style of Pan	Select One Below	Outside Dimension	Inside
Flat Disc (Round)	<input type="checkbox"/>	<input type="text"/>	N/A
Flat Plate (Square)	<input type="checkbox"/>	<input type="text"/>	N/A
Pan (Round with lip)	<input type="checkbox"/>	<input type="text"/>	<input type="text"/>
Pan (Square with lip)	<input type="checkbox"/>	<input type="text"/>	<input type="text"/>

Size of Lip if different from 1" each side

LINEAR / RECTANGULAR PANS: (with Lip or Plate) Fill out where applicable

Dimensions: Length Width

Linear Burner Flame Pattern : Select One Field of Fire (H Style) Single Row of Fire

Lip Required YES NO Size of Lip if different from 1" each side

CUSTOM BURNER ONLY: Select Shape

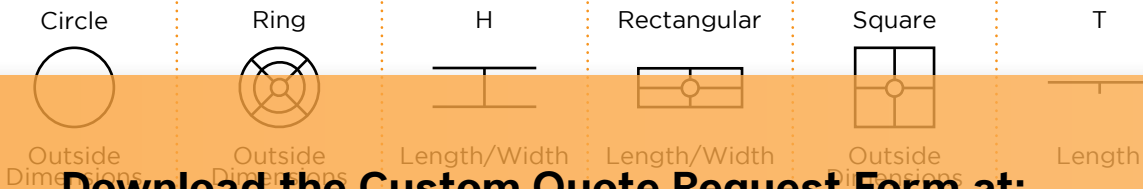

Download the Custom Quote Request Form at:
www.firegearoutdoors.com/customform

BURNER FLAME EXPECTATIONS:

BTU set at 20,000 per linear foot. Example: A 4 foot burner would have an orifice rated at 80,000 BTU.

Expected Height of Flame

Please help us understand the enclosure that the Custom Burner will be installed in. If you have drawings or pictures, please provide those as attachments. The more details we have the smoother the quote process will be.

ENCLOSURE DETAILS : Select or fill in where applicable

Constructed of: CMU (Concrete Masonry Unit) RTF (Ready to Finish Enclosure) SRW / Brick

Height & Width of Enclosure:

Height Width Depth

EXTERIOR ENCLOSURE FINISHING MATERIALS : Select all that apply

Manufactured Stone Real Stone Paver / Brick Stucco Other

VENTILATION : A minimum of 18 square inches of cross ventilation (2 opposite sides) is required to keep the components in good working order.

Size of vents being installed Do you want Firegear to provide vents? YES NO

SAVE FORM BEFORE SENDING

EMAIL TO : INFO@FIREGEAROUTDOORS.COM or FAX TO : 888.672.8024



9230 Conservation Way
Fort Wayne, IN 46809

Tech: 1.855.498.8324
Sales: 1.888.699.6167