

# PUSH-BUTTON / FLAME SENSING FIRE PIT INSERT



Penta 25FPPK



FPPK42X14-H

---

## FPPK Series

### Installation & Operation Instructions



Hearth Products Controls

Fire-inspired since 1975.

830-FPPK



**This is a Safety Alert Symbol**

When you see this symbol on the fire pit insert, or in this manual, look for one of the following signal word panels alerting you to the potential for personal injury, death or major property damage.

**IMPORTANT**

Necessary instructions

**WARNING**

**FOR OUTDOOR USE ONLY**

**WARNING**

Improper installation, adjustment, alteration, service, or maintenance can cause injury or property damage. Read the installation, operating, and maintenance instructions thoroughly before installing or servicing this equipment.

**WARNING**

- Do not store or use gasoline or other flammable vapors and liquids in vicinity of this or any other appliance.
- An LP-cylinder not connected for use shall not be stored in the vicinity of this or any other appliance.

 **DANGER**

If you smell gas:

- 1) Shut off gas to appliance.
- 2) Extinguish any open flame.
- 3) If odor continues, keep away from appliance and immediately call gas supplier or fire department.

 **DANGER**

 **CARBON MONOXIDE HAZARD**

This appliance can produce carbon monoxide which has no odor. Using it in an enclosed space can kill you.

Never use this appliance in an enclosed space such as a camper, tent, car or home.

The content of this manual may be revised without prior notice. Please consult with your Hearth Products Controls representative to obtain the most current version.



Hearth Products Controls

# Table of Contents

---

<b>1 Important Safety Information</b> .....	3
Technical Support .....	3
Symbol Legend .....	4
Important Safety Information for Installers .....	5
Important Safety Information for End-Users.....	5
<b>2 Product Features and Parts List</b> .....	6
<b>3 Selecting the Fire Pit Location</b> .....	7
<b>4 Overhead Structures and Sidewall Clearance Requirements</b> .....	8
<b>5 Fire Pit Enclosures Requirements</b> .....	10
<b>6 Remote LP Tank System Enclosure Requirements - If Applicable</b> .....	12
<b>7 Installing the Fire Pit</b> .....	16
<b>8 Adding Approved Media</b> .....	17
<b>9 Operating the Fire Pit</b> .....	19
<b>10 Maintaining the Fire Pit</b> .....	21
<b>11 Troubleshooting</b> .....	23
<b>12 Compatible Accessories</b> .....	24
<b>13 Replacement Parts</b> .....	24
<b>14 Warranty</b> .....	25



Hearth Products Controls



# Table of Contents

---

- Hearth Products Controls Company recommends that our products are installed by professionals locally licensed by the authority having jurisdiction in gas piping. All installation instructions must be followed to ensure proper performance and safety. Hearth Products Controls Company assumes no responsibility for problems relating to the installation.
- To qualify for warranty, all instructions must be strictly followed. Otherwise, warranty may be void. Never alter product or configuration in any way.
- Annual servicing should be handled by professionals certified in the US by the National Fireplace Institute (NFI) as NFI Gas Specialists or in Canada by WETT (Wood Energy Technical Training).
- It is the installer's responsibility to ensure a safe installation and to educate the end-user regarding the features, safety recommendations and proper operation of this product.
- Please reference page 1 for all warnings.

**INSTALLER:**

Leave this manual with the appliance.

**END USER:**

Retain this manual for future reference.

**SELECT MODELS**

Certified to  
**ANSI Z21.97-2014**  
**CSA 2.41-2014**



---

## Technical Support

For information and support contact your Hearth Products Controls dealer.



Hearth Products Controls

# 1 Important Safety Information

---

## Symbol Legend



### This is a Safety Alert Symbol

When you see this symbol on the fire pit insert, or in this manual, look for one of the following signal word panels alerting you to the potential for personal injury, death or major property damage.



Necessary instructions



Hearth Products Controls

# 1 Important Safety Information

***Please reference page 1 for all warnings.***

## Important Safety Information for Installers

Leave this manual with the end-user and instruct them to retain it for future reference. Instructions and product updates are also available at [www.hpcfire.com](http://www.hpcfire.com) under the Support tab.

Installers must carefully follow the instructions in this manual to prevent personal injury or property loss. These instructions contain information critical to the safe installation and operation of the fire pit.

- Instructions are updated as needed. It is the responsibility of the installers to check for product updates and installation manual updates at [www.hpcfire.com/support.html](http://www.hpcfire.com/support.html) prior to installation.
- It is the responsibility of the installer to follow:
  - The National Fuel Gas Code, ANSI Z223.1/NFPA 54 or International Fuel Gas Code.
  - The National Electrical Code, ANSI/NFPA 70.
  - Local codes
- Only use gas/fuel type specified for this fire pit as noted on the fire pit control box label. NEVER use an alternative fuel to include bio-fuel, ethanol, lighter fluid or any other fuel.
- Gas pressure and type should be checked prior to installation and use.
  - **Natural Gas Fire Pit:** Supply Pressure: Minimum: 3.5 inches W.C.; Maximum: 7.0 inches W.C.
  - **LP Gas:** Supply Pressure: Minimum: 8.0 inches W.C.; Maximum: 11.0 inches W.C.

## Important Safety Information for End-Users

- Never leave an operating fire pit unattended or with someone not familiar with its operation or emergency shut-off locations.
- Both children and adults should be alerted to the hazards of high surface temperatures and should stay away to avoid burns and clothing ignition.
- Young children should be carefully supervised when they are in the area of fire pit.
- Keep the appliance area clear and free from combustible materials, gasoline, and other flammable vapors and liquids.



Hearth Products Controls

## 2 Product Features and Parts List

---

FirePitInsert  
Installation and Operation Instructions



Hearth Products Controls



### 3 Selecting the Fire Pit Location

---

**NOTE:** All fire pits and systems are designed and intended for outdoor use only.

**IMPORTANT**

It is recommended that material such as granite, marble or other dense stone be kept away from heat and especially flame due to risk of cracking. HPC is not responsible for damage resulting from failure to follow these recommendations.

- Select a location that
  - ensures above-grade installation of the fire pit.
  - offers good drainage.
  - allows easy access for installation and maintenance of the fire pit.
  - provides sufficient horizontal room to enjoy the fire pit while allowing a safe distance from the heat and flame.
- Fire pits create very high temperatures. For clearances refer to table 3.1. Clothing or other flammable materials should not be placed on or near fire pit.

#### Clearances around Fire Pit

Fire Pit Clearances	Up to 142K
Under Valve Box when applicable for drainage	2"
Sides Surrounding Fire Pit From Structure or Combustibles	36" (12" for noncombustibles)
Overhead Clearance above Product	84"

Table 3.1 – Fire Pit Clearances



Hearth Products Controls

# 4 Overhead Structures and Sidewall Clearance Requirements

It's important to review the clearance requirements below for any type of overhead structure such as pergola, roof, overhang, screens, arbor, etc. or a sidewall to ensure that the distances are met. Figures 4.1 and 4.2.

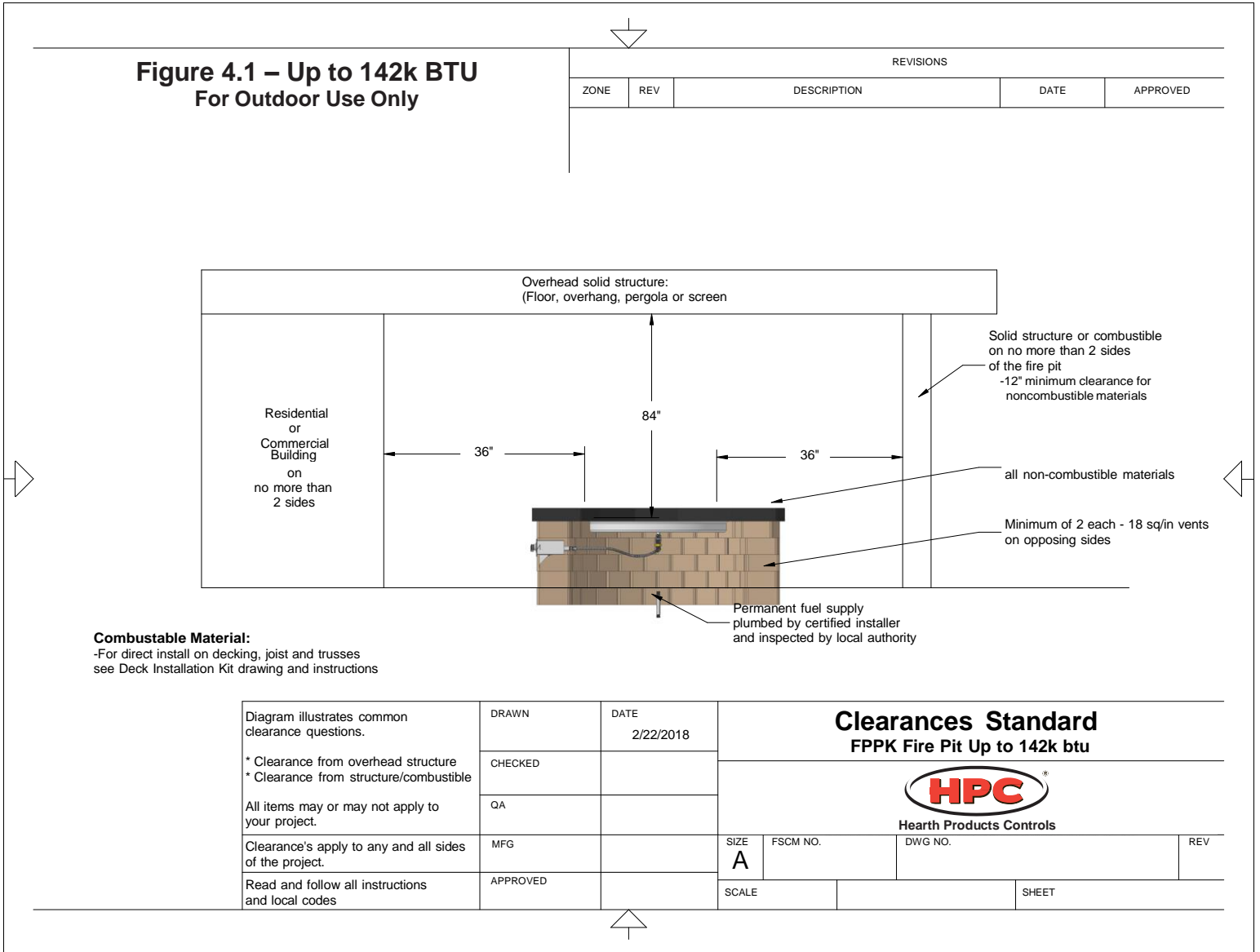
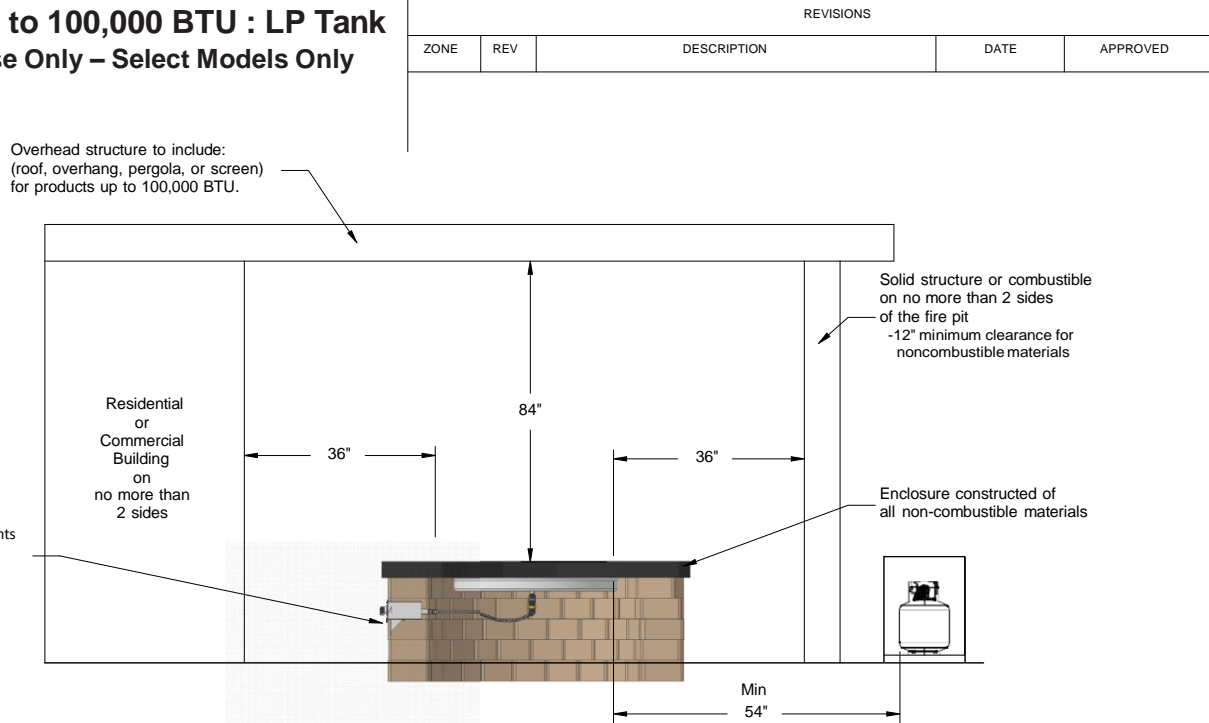

Table 4.1 – Clearances for standard fire pit up to 142k BTU

# 4 Overhead Structures and Sidewall Clearance Requirements

**Figure 4.2 – Up to 100,000 BTU : LP Tank  
For Outdoor Use Only – Select Models Only**



**Combustable Material:**  
-For direct install on decking, joist and trusses  
see Deck Installation Kit drawing and instructions

REVISIONS				
ZONE	REV	DESCRIPTION	DATE	APPROVED

Diagram illustrates common clearance questions.  * Clearance from overhead structure * Clearance from structure/combustible  All items may or may not apply to your project.	DRAWN	DATE	<b>Clearance LP tank fire pit up to 100k BTU</b>		
	CHECKED	2/22/2018			
	MFG		SIZE <b>A</b>	FSCM NO.	DWG NO.
Clearance's apply to any and all sides of the project.	APPROVED		: ALE SHEET		



Hearth Products Controls

Table 4.2 – Clearances for LP tank fire pit up to 100k BTU



Hearth Products Controls

## 5 Fire Pit Enclosures Requirements

---

### Location and design

- The enclosure must be installed above-grade and allow for drainage to prevent water damage to fire pit.
- Refer to cut sheets on our website for important dimensional information for your fire pit. Visit [www.hpcfired.com](http://www.hpcfired.com)
- The fire pit assembly should be recessed a minimum of two inches from the top of the enclosure to protect flame from being blown out.
- It is recommended that material such as granite, marble or other dense stone be kept away from heat and especially flame due to risk of cracking. Manufacturer is not responsible for damage.
- The enclosure must be constructed on a stable surface and be level. HPC recommends the use of the installation collar (optional) that may be mortared into or sandwiched between layers of the enclosure.
- The weight of the fire pit must be supported by the pan and not by any control/valve box.
- HPC recommends that the pan lip is recessed on a trough (linear), and large round enclosures, Figure 5.1. **NOTE:** HPC cannot guarantee the lip on all of our products will be perfectly flat and will not warp due to heat.
- There must be a minimum of 2 inches under the valve box for proper ventilation and drainage, see clearance drawings on page 8 and 9.
- The product must be accessible for service.



Figure 5.1 – Pan lip recessed on a trough.



# 5 Fire Pit Enclosures Requirements

---

## Construction materials

- Use non-combustible materials and construction for gas supply, power and enclosure.
- The interior void space of the enclosure surrounding the valve box cannot be filled with any material (gravel, crushed rock, concrete, etc.).

## Venting

- The enclosure must incorporate at least two vents to allow heat and or residual fuel to escape. Failure to properly vent the enclosure may result in the fire pit overheating or explosion.
- Some enclosures may require more ventilation based on material, size, and extended use.
- The vent may also work as a drain when installed at bottom sidewall to prevent water build up.
- Vent specifications:
  - A minimum of two vents (18 square inches for each vent) on opposing sides of the enclosure totaling 36 inches of free area are required (example: 3-inch x 6-inch or larger). Or, multiple vents uniformly made throughout the enclosure totaling 36 square inches or more of free area are acceptable.
  - Installation of the vents in the mid-to-lower area of the enclosure is recommended.

## Fuel line

- Fire pit must have a gas shutoff on the outside of the exterior of the fire pit to allow for emergency shut off and maintenance. The gas shutoff should not be used to adjust flame height.
- The installer is responsible for using the correct fuel line sizing that is able to supply the stated maximum BTU for the product—refer to product label on the fire pit for specifications.



## 6 Remote LP Tank System Enclosure Requirements - If Applicable

### IMPORTANT

Only select models of Push-Button / Match-Lit (FPPK and MLFPK) fire pits are permissible for small tank use. Please see the HPC product catalog, visit [www.hpcfire.com](http://www.hpcfire.com), or contact your HPC dealer for details.

### IMPORTANT

Locate the hose out of pathways to avoid accidental damage and prevent it from becoming a trip hazard.

For an enclosure using an LP tank system, follow these recommended specifications:

- You must follow local codes.

### IMPORTANT

The remote LP tank / enclosure should be a minimum of 54 inches from the fire pit.

- One side of the enclosure shall be completely open; OR
- For an enclosure having four sides, a top, and a bottom:
  - At least two ventilation openings shall be provided in the side walls of the enclosure, located within 5 inches (127mm) of the top of the enclosure, equally sized, spaced at a minimum of 180 degrees, and unobstructed. The opening(s) shall have a total free area of not less than 1 in<sup>2</sup> lb (14.2 cm<sup>2</sup>kg) of stored fuel capacity. See Figure 6.1.
  - Ventilation opening(s) shall be provided at the floor level of the enclosure and shall have a total free area of not less than 1/2 in<sup>2</sup> lb (7.1 cm<sup>2</sup>kg) of stored fuel capacity. If ventilation openings at floor level are in a side wall, there shall be at least two openings. The bottom of the openings shall be 1 inch (25.4mm) or less from the floor level and the upper edge no more than 5 inches (127mm) above the floor level. The openings shall be equally sized, spaced at a minimum of 180 degrees and unobstructed. See Figure 6.1.
- Every opening shall have minimum dimensions so as to permit the entrance of an 1/8 inch (3.2mm) diameter rod.

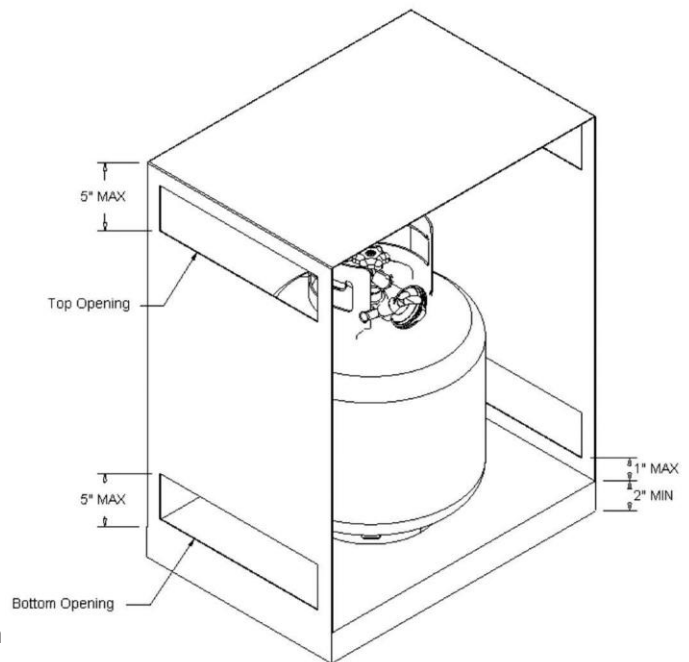

Figure 6.1 – Top and bottom side ventilation openings for LP tank enclosure.



## 6 Remote LP Tank System Enclosure Requirements - If Applicable

---

- Ventilation openings in sidewalls shall not communicate directly with other enclosures of the appliance. See Tables 6.1 and 6.2.

LP Tank Size	Top Opening	Bottom Opening
20 LB (9.1 KG)	20 in <sup>2</sup> (130 cm <sup>2</sup> )	10 in <sup>2</sup> (65 cm <sup>2</sup> )
30 LB (13.6 KG)	30 in <sup>2</sup> (195 cm <sup>2</sup> )	15 in <sup>2</sup> (100 cm <sup>2</sup> )

Table 6.1 – LP tank enclosure opening specifications by tank size.

LP Tank Enclosure Specifications
2 Openings for each top and bottom - 180° apart
From LP tank base to bottom of opening - Max. 1" (25.4mm)
From floor to base of LP tank - Min. 2" (50.8mm)

Table 6.2 – LP tank enclosure opening specifications.

- The cylinder valve shall be readily accessible for hand operation. A door on the enclosure to gain access to the cylinder valves is acceptable, provided it is non-locking and can be opened without the use of tools. Designs using a cover to gain access to the cylinder and cylinder valve shall be provided with handles or the equivalent at a minimum of 180 degrees apart to facilitate lifting of the cover.
- The enclosure for the LP-gas cylinder shall isolate the cylinder from the burner compartment to provide:
  - Shielding from radiation;
  - A flame barrier; and
  - Protection from foreign material.
- There shall be a minimum clearance of 2 inches (50.8mm) between the floor of the non-disposable LP-gas cylinder enclosure and the ground.
- The design of the enclosure shall be such that:
  - A non-disposable LP-gas cylinder can be connected, disconnected, and the connections inspected and tested outside the cylinder enclosure; and
  - Those connections, which could be disturbed when installing the cylinder in the enclosure, can be leak-tested inside the enclosure.



## 6 Remote LP Tank System Enclosure Requirements - If Applicable

---

### Propane Cylinder: Safety Requirements

- This appliance has been designed for use with a 20-lb. or 30-lb. size propane cylinder (not supplied).
- The propane cylinder should be checked by your propane supplier prior to installation and use.
- Never use a cylinder with a damaged valve. A worn cylinder may be hazardous and should be checked by your propane supplier.
- Use only a propane supply cylinder constructed and marked in accordance with the specifications for LP gas cylinders by the National Standard of Canada, CAN/CSA B339, Cylinders, Spheres and Tubes for Transportation of Dangerous Goods; and Commission, as applicable or the Specifications for LP-Gas Cylinders of by the U.S. Department of Transportation (DOT).
- Do not store a spare LP-gas cylinder under or near this appliance.
- Never fill the cylinder beyond 80 percent full.
- Only use the pressure regulator and hose assembly provided with this appliance or replacement pressure regulators and hose assemblies as specified by the manufacturer. The regulator supplies a pressure of 11 inches water column to the appliance and has a QCC1 type fitting.

### Propane cylinder specifications

- The propane cylinder must be provided with a cylinder connection device compatible with the connection for outdoor appliances.
- The propane cylinder must be supplied with a shut-off valve terminating in a propane cylinder valve type QCC1 and include a collar to protect the cylinder valve. A QCC1 cylinder has a positive seating connection, which will not allow gas to flow until a positive seal has been achieved. It is also equipped with an excess flow device. In order to attain full flow to the appliance, the valve must be in the off position when the cylinder valve is turned on.
- The propane cylinder must have a safety relief device having direct communication with the vapor space of the cylinder.
- The cylinder supply system must be arranged for vapor withdrawal.
- The cylinder shall incorporate listed overfill protection device (OPD).





## 6 Remote LP Tank System Enclosure Requirements – If Applicable

### Locating the LP tank:



Figure 6.2

### Securing the LP tank:

1. Fasten the L-bracket to the bottom of the propane tank using the nut and bolt (supplied). Ensure the nut is tight and will not loosen.
2. Select the location for the propane tank following the guidelines above, Figure 6.2.
3. Screw the bracket to the mounting surface. For concrete surface, use a concrete anchor (not supplied). Ensure that screw is tight so that the cylinder cannot move.

### Connecting the Cylinder:

1. Ensure the gas regulator has no kinks and is smooth.
2. Remove the cap or plug from the cylinder fuel valve.
3. Insert the black QCC1 regulator nipple onto the QCC1 fuel valve and tighten until snug. Do not use tools.
4. Perform a leak test on all joints prior to using the gas appliance. A leak test must be performed annually and each time a cylinder is hooked up or if a part of the gas system is replaced.
5. Follow the instructions for natural gas hook-up if the appliance is to be connected directly to a house propane gas supply line.

#### WARNING

Failure to follow location and mounting guidelines for the LP tank could result in serious injury.

#### WARNING

- Locate the LP Tank and enclosure out of pathways to avoid accidental damage and prevent them from becoming a trip hazard.
- Locate the hose out of pathways to avoid accidental damage and prevent it from becoming a trip hazard.

#### WARNING

- Always ensure L-bracket is securely fastened to prevent the LP tank from tipping.

#### INSTALLATION

We suggest that our products be installed by professionals that are locally licensed by the authority having jurisdiction in gas piping.



# 7 Installing the Fire Pit

---

## INSTALLATION

We suggest that our products be installed by professionals that are locally licensed by the authority having jurisdiction in gas piping.

### IMPORTANT

To prevent damage, unhook the fire pit from the gas supply for pressure leak tests.

### IMPORTANT

**Burn Testing:** It is the responsibility of the qualified installer to test for gas leaks at all connections.

### IMPORTANT

**Gas Plumbing Connections:** Use joint compound or tape that is resistant to all gases. Apply joint compound only to all male pipe fittings. **DO NOT use on flex line flared fittings.** Be sure to tighten every joint securely.

- Perform all leak tests with leak detector or leak reactant.

### Installation Steps:

1. Set fire pit in properly constructed enclosure, read **Section 5 – Fire Pit Enclosure Requirements.**
2. Position fire pit following safety recommendations with access to all gas connections for testing. Read **Section 3 – Selecting the Fire Pit Location** for more details.
3. Shut off gas supply to fire pit.
4. Connect fire pit to main gas supply. Warning: avoid sharp bends with flex line to prevent whistling.
5. Turn on gas supply, purge gas lines of air and perform leak test on all inlet connections. Repair as needed.
6. Light fire pit. It may take several cycles to purge air from the lines. Read **Section 9 – Operating the Fire Pit.**
7. Once fire pit is lit, perform leak test on all gas connections. Repair as needed.
8. Turn off fire pit and allow it to cool.
9. Apply media as described in **Section 8, Adding Approved Media.** When filling the pan with lava rock and/or decorative glass, the instructions in Section 8 must be followed.
10. Turn on fire pit again and perform leak test with media correctly installed. If gas leak is detected verify correct media application and repair as needed.
11. Verify correct operation and lighting.
12. Review safety manual with end-user. Instruct end-user that fire pit or media must not be changed or modified.
13. Leave manual with end user.
14. Apply the Start Up and Shutdown decal next to control box in an obvious and highly visible position.

### IMPORTANT

For Penta Burner inserts, flame will be smaller with no media on the burner.



Hearth Products Controls

## 8 Adding Approved Media

---

### WARNING

FOR GLASS MEDIA USAGE WITH LP GAS- WHEN USING APPROVED DECORATIVE GLASS TO COVER BURNER APPLY ONLY ENOUGH TO HIDE BURNER. APPLYING OVER 1/2" MAY CREATE BACK PRESSURE AND GAS LEAKAGE FROM AIR MIXER RESULTING IN LP POOLING UNDER FIRE PIT.

### WARNING

FOR GLASS MEDIA USAGE WITH LP GAS- THE UNIT MUST BE TESTED WITH MEDIA OVER BURNER FOR CONFIRMATION OF NO BACK PRESSURE CREATING GAS TO LEAK OUT OF AIR MIXER VENTURI HOLES. THIS MAY HAVE TO BE DONE PRIOR TO PLACING IN ENCLOSURE IF NO ACCESS DOOR.

### WARNING

Never use any material that is non-porous or holds moisture such as gravel, pebbles, river rock, etc. When heated, non-porous material will not allow heated steam to readily escape which can break and cause personal injury or damage. Material that holds moisture can boil and fracture unexpectedly when exposed to heat.

**IMPORTANT** The fire pit is designed to use approved media correctly installed over the burner to achieve proper combustion.

- Never install a mesh or screen under the media.
- Media affects flame pattern greatly. It is possible to create an unusual flame pattern that could damage your enclosure. Enclosure damage from an open flame fire feature is not covered under any warranty.
- The use of concrete logs is not recommended.









# 8 Adding Approved Media

## Application of Approved Media

Please follow the instructions below to add the finishing touch to your fire pit.

Particular attention needs to be on the pilot assembly area.

Incorrect media installation will cause the pilot flame to suffocate and turn off pit or delay main burner ignition.

Lava Rock Only Application	Decorative Glass Application
<p>1) Install your fire pit per instructions.</p>  <p>2) Apply lava rock ONLY deep enough to cover ring.</p> 	<p>1) Install your fire pit per instructions.</p>  <p>2) Fill pan with media. Cover burner with 1/4 to 1/2 inches of glass. Do not overfill pan with glass. All LP installations must be checked for back pressure with media installed. Failure to do so may result in personal injury or property damage.</p> 
<p>1) Blowout Box: Leave vents open. Do not cover vents with lava rock or allow any rock to block flame opening. Incorrect media installation will cause the pilot flame to suffocate and turn off pit or delay main burner ignition.</p> <p>2)</p>  <p>Do not cover box vents!</p>	<p>3) Blowout Box: Do not cover blowout box vents or opening with glass. Incorrect media installation will cause the pilot flame to suffocate and turn off pit or delay main burner ignition.</p>  <p>Do not cover box vents!</p>  <p>Do not cover pilot opening!</p>



## 9 Operating the Fire Pit

---

- Before use, be sure to test all gas connections for leaks. Do not use fire pit if there is any evidence of leaking gas. If leaking gas suspected, turn off the main gas supply and repair immediately.
- Do not use the enclosure as a seating area. Wind and gusty conditions will affect the flame in an unpredictable manner. If conditions exist that are not safe for patrons, turn off the fire pit.
- The hose should be inspected before each use of the fire pit and replaced prior to use if there is evidence of excessive abrasion or wear or if the hose is damaged. The replacement hose assembly shall be that specified by the manufacturer.
- Do not use the fire pit if any part has been under water. Immediately call a qualified service technician to inspect the fire pit and to replace any part of the control system and any gas control that has been under water.
- Never use any material that is non-porous and holds moisture such as gravel, pebbles, river rock, etc. This material, when heated will cause the trapped moisture to boil and fracture unexpectedly. This material is not sufficiently porous to allow heated steam to readily escape which can break and cause personal injury or damage.
- Solid fuels shall not be burned in the fire pit.
- Leaves, sticks, wood, paper, clothing, food material, should be kept away from the fire pit. Clothing or other flammable materials should not be hung from the appliance or placed on or near the appliance. Keep the appliance area free from gasoline, and other flammable vapors and liquids.
- Fire pit is not for cooking.
- Make sure that there is no vegetation or other objects over the top or sides of the fire pit that could interfere with safe operation. See clearances in **Section 3 – Selecting the Fire Pit Location**.
- If lava rock is wet, allow the fire pit to burn for 45 minutes prior to coming within 15 feet of the fire pit.
- When the fire pit is not in operation, turn off gas valve.
- When not in use, the fire pit must be covered at all times.



## 9 Operating the Fire Pit

### FPPK Push-Button Flame Sensing Start-up

1. STOP! Read the safety information on “If you smell gas”, **Section 1 – Important Safety Information**.
2. Ensure fire pit is clear of people and debris. Remove any covers and the fire pit is safe to start.
3. Turn gas supply valve to fire pit to ON position
4. Rotate gas valve knob counter clockwise to pilot light position
5. Depress and hold the valve knob.
6. Turn ON spark igniter by depressing switch in short burst until pilot lights.

7. Once lit, release switch for spark igniter while continuing to depress valve knob for 20 seconds.
8. Turn knob counter clockwise to light main burner.

**NOTE:** If the burner fails to light, wait 5 minutes for gas to clear, then repeat steps 3-8.

9. Ensure fire pit, children and patrons are supervised by a responsible adult who is familiar with emergency shut-down.
10. Flammable materials should not be placed on or near the fire pit.

**This product is intended to be connected to fixed piping systems or an LP small tank (only on select models).**



### DANGER

If you smell gas:

- 1) Shut off gas to appliance.
- 2) Extinguish any open flame.
- 3) If odor continues, keep away from appliance and immediately call gas supplier or fire department.

### FPPK Shutdown

1. Turn “off” fire pit by slightly pressing and turning valve clockwise to “OFF” position, Figure 9.1.
2. Slightly push in and turn clockwise to extinguish pilot, Figure 9.2.
3. Turn off main gas valve to fire pit.
4. After fire pit has cooled, cover fire pit.



Figure 9.1



Figure 9.2



# 10 Maintaining the Fire Pit

- Any guard or protective device removed for servicing must be replaced prior to operating the fire pit.
- We suggest that our products be serviced annually by a professional certified in the US by the National Fireplace Institute (NFI) as NFI Gas Specialists.
- Ensure gas is shut off and fire pit is cool before servicing.
- Keep fire pit covered at all times when not in use and free of debris.
- In some areas of the country, spiders or insects have been known to build nests and/or lay eggs in the venturi holes of the air-mixer for LP units. This can cause fuel to fill the fire feature cavity and result in personal injury or property damage. Periodic inspection by a qualified service technician of the air-mixer is required to ensure your fire feature performs properly, Figure 10.1.
- **Burner Cleaning: One time a year.** If flames exhibit any abnormal shapes or behavior, or if burner fails to ignite properly, then the burner holes may require cleaning. The appliance can be cleaned by carefully removing the logs and media to allow access to burner. Use a brush to carefully remove dust, spider webs, and loose particles from base, logs, and fire ring itself. If evidence of damage, fire ring must be replaced with fire ring specified by the manufacturer.
- **Thermocouple cleaning of soot: Once every six months or as needed.** Remove lava rock & glass around pilot, then the blowout box lid. Clean thermocouple of any soot using soft brush. Be careful not to damage hot wire element. Place lava rock or glass back as explained in **Section 8 – Adding Approved Media.**
- **Visually inspect the pilot.** The pilot flame should cover 3/8 inch to 1/2 inch of the thermocouple, Figure 10.2. Cleaning of the pilot orifice may be required by removing pilot hood counter clockwise and removing orifice, Figure 10.3.

## Service



We suggest that our products be serviced by a professional certified in the US by the National Fireplace Institute (NFI) as NFI Gas Specialists.



Figure 10.1 – Locating orifice for cleaning



Figure 10.2 – Pilot flame coverage of thermocouple.

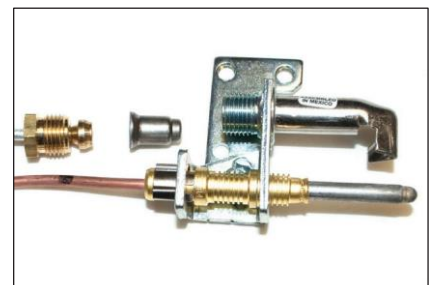

Figure 10.3 – Cleaning pilot orifice



# 10 Maintaining the Fire Pit

## Installing / Changing Batteries to Spark Igniter Unit in Valve Box

Carefully unscrew the spark igniter unit cap, Figure 10.4.

1. Remove cap with battery, Figure 10.5.
2. Remove old battery from cap, install new battery
3. Holding by cap, slide battery into spark igniter unit, Figure 10.6 .
4. Tighten cap lightly- DO NOT over tighten.

We recommend using Alkaline battery.



Figure 10.4 – Unscrew spark igniter unit cap.



Figure 10.5 – Remove igniter unit cap with battery.



Figure 10.6 – Slide battery into spark igniter unit.



Hearth Products Controls



# 11 Troubleshooting

Table 11.1, below indicates some potential causes and countermeasures to the symptoms indicated in bold type. **Please contact your retailer or certified technician for service and repair.**

### Service



We suggest that our products be serviced by a professional certified in the US by the National Fireplace Institute (NFI) as NFI Gas Specialists.

Problem	Possible Causes	Solution
<b>Pilot Will Not Light</b>	Air in gas line	New install - may take several attempts Check gas level of LP tank
	No gas flow - gas not ON or line obstruction	Confirm gas is ON upstream Possible debris in line: insulation, dirt, plastic, etc.
	Pilot orifice dirty or clogged	Remove orifice and clean (Section 10)
<b>Pilot will not light with spark igniter but will light with a match</b>	Dead or incorrectly installed battery	Replace properly with good AA battery (Section 10)
	Improper gap at electrode tip	The gap can be adjusted by bending the tip in or out while holding electrode stable above ceramic block to achieve spark
<b>Pilot will not stay lit when control knob released</b>	Knob not being held in long enough	Thermocouple must have time to heat up. Hold the knob in for 30 seconds after pilot lights.
	Small pilot flame: pilot orifice dirty or clogged	Remove pilot orifice and clean
	Dirty thermocouple	Clean using soft brush (Section 10)
	Faulty thermocouple or valve	Replace thermocouple or valve
<b>Burner will not stay lit</b>	Gas pressure improper	Confirm proper gas pressure (See Section 1 – Important Information for Installers)
	Burner obstructed	Confirm no water or debris in burner
	Improperly applied or too much media	Re-apply media (Section 8)
	Too windy	Use when less windy or with our wind guard (See page 24, Figure 12.1)
<b>Low flame when turned to High</b>	Gas pressure improper	Confirm proper gas pressure (See Section 1 – Important Information for Installers)
	Propane (LP) - Improper lighting procedure	Fire pit valve must be OFF when tank is turned ON. Turn ON tank slowly to allow pressure to equalize
	Lack of gas	Check gas level of LP tank
	Supply hose is pinched	Reposition supply hose as necessary
	Natural Gas (NG) - undersized gas supply line	Gas pipe, flex line, shutoff valve, etc. must be sized to deliver fire pit input pressure & BTU requirement
<b>Flame is creating large amount of soot</b>	Propane (LP) - mesh spider guard or venturis are blocked with debris - grass, dirt, etc.	Thoroughly clean spider guard - (Section 10)
<b>Noise when lit</b>	Whistling - flex line bent too sharp	Re-route flex line to reduce bend
	Propane (LP) - Humming regulator	Not a defect - normal occurrence on hot days due to internal vibrations in regulator

Table 11.1 – Troubleshooting



## 12 Compatible Accessories

---

- **Wind guards** – Clear glass wind guards protect flames from being blown out in windy conditions as well as personal belongings from being blown into the fire. Available in round, linear and square shapes. See Figure 12.1.
- **Fire pit cover** – Hearth Products Controls has decorative copper covers and heavy-duty vinyl covers for your fire pit that will protect it from rain, snow, and moisture. See Figure 12.2.

For a complete list of accessories, visit [www.hpcfire.com](http://www.hpcfire.com)



Figure 12.1 – Wind guard



Figure 12.2 – Fire pit cover

## 13 Replacement Parts

---

Please contact your dealer for parts – if unsure please contact HPC or visit our website at [www.hpcfire.com](http://www.hpcfire.com) and we will be happy to help you



Hearth Products Controls

## 14 Warranty

---

### Limited Warranty

Hearth Products Controls Company (HPC) warranties fire pits against manufacturing defects that prevent safe and correct function as follows:

- Electronics, Gas valve: Commercial-1 yr; Residential- 3 yr.
- Pilot Assembly: Commercial- 1 yr; Residential- 2 yr.
- Stainless Steel Pan, Fire Ring, & Valve Box: Commercial-1 yr.; Residential-5 yrs.

This commences from the date of original sale / shipment from HPC FOB Dayton, Ohio. This warranty is for parts and in-house (HPC) labor. The defective product must be sent back to HPC with a Return Merchandise Authorization (RMA) issued by HPC for that specific product and any other additional information for the nature of the defect or warranty claim.

The warranty does not cover items that have been damaged by overheating, modification, abuse, or improper storage. Also any labor involving installation or maintenance with the unit is not covered.

This warranty excludes claims for consequential, indirect-collateral expenses arising from product defects or warranty recovery.



**Hearth Products Controls**

**Fire-inspired since 1975.**

3050 Plainfield Road  
Kettering, Ohio 45432

For detailed product information, go to [www.hpcfire.com](http://www.hpcfire.com)