

Type MB Wall Fan Packages



Type MB Fan Packages

Application: *Versatile*

Type MB fan packages have been specifically designed for use with C-fans ranging in size from 24 to 60 inches. The design allows for more versatility of use in all applications where a complete fan package is desired. These complete packages greatly simplify the specification and use of ventilation equipment in commercial and industrial metal buildings.

Fan packages are shipped completely assembled and each package includes fan, shutter, guard, and housing as standard.

By expanding upon the original design to allow for flexible usage, American Coolair MB fan packages are now more practical and efficient for use in *supply* or *exhaust* applications.

Drive Mechanism: *Unique*

Type MB Belt drive models are designed for quiet operation and low initial cost, using a variety of available motors. Each model incorporates a unique American Coolair fan bearing and shaft assembly whereby a shaft is mounted on a cross-frame member and the power is applied directly to a cast aluminum hub. Drive belt power is applied to the fan/hub assembly in the same plane as the bearings. This reduces bearing load and dramatically increases fan life. Bearings are permanently lubricated and sealed.

Most models are equipped with a variable pitch motor pulley which allows fan speed adjustment where desirable.

The setting made at the factory operates the fan at the maximum safe load of the motor. The pulley may be opened to reduce fan speed and thus decrease air flow and sound levels.

If an increase in fan speed is desired, contact your American Coolair representative for information on fan performance and motor load before making any adjustment.

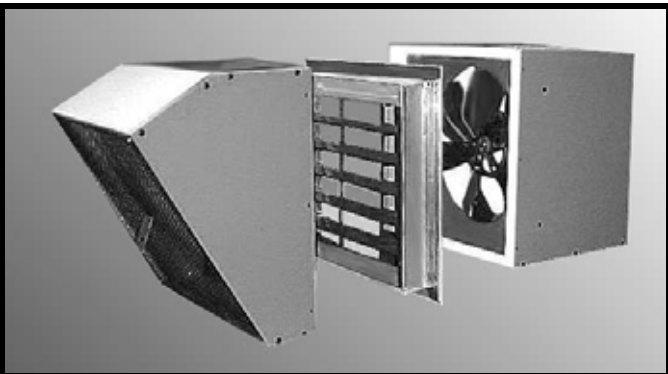

MB fan package for exhaust with optional discharge hood

Construction: *Rigid, Long-Lasting*

The wall housing is fabricated of galvanized steel for rigidity, long life and years of protection against rust and corrosion. An exterior finish coat of epoxy can be specified.

Type MB fan packages feature aluminum shutters with reinforced interlocking blades.

The fan panel is fabricated of heavy-gauge steel, and the uprights which support the motor and propeller are formed from heavy-gauge steel angle for maximum strength and rigidity.

- The fan panel assembly, mounted in the wall housing, utilizes all-welded construction.
- The deep spun venturi orifice is specifically engineered to provide maximum efficient air movement and quiet operation.
- The shutter is counterbalanced for automatic (gravity) operation.
- All propeller blade assemblies are dynamically balanced.
- Parts requiring painting are processed through the advanced American Coolair multi-stage pretreatment system prior to the application of any coatings to ensure maximum finish adhesion. For additional protective coating options, see the **Accessories** section on Page 6.

Motors: *Efficient, Economical*

American Coolair's air-over-motor design provides extra capacity and economy because air velocity over motor is used to dissipate heat and thus increase horsepower capability.

Totally-enclosed motors are standard for MB fan packages. Several motor alternatives are available to fit your specific needs such as explosion-proof, energy-efficient, and severe-duty.

Only nationally recognized brand motors with nationwide service facilities are used.

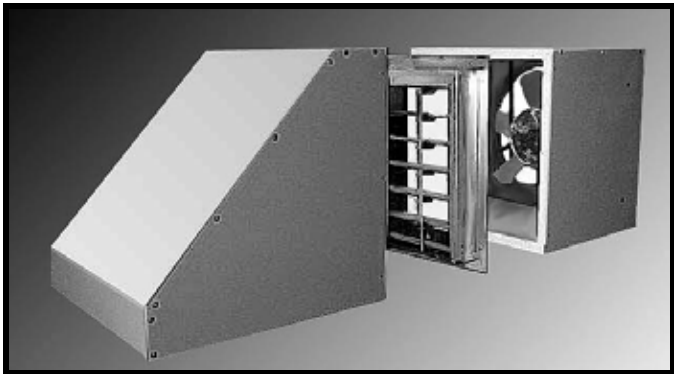

MB fan package for supply with optional inlet hood (for better all-weather protection in supply configuration, a motorized SR or SU inlet shutter is recommended)

Selection

The following are some of the basic considerations in determining which model and how many fan packages are needed for a specific building. A more thorough discussion of the fan selection is available in American Coolair's "Industrial and Commercial Ventilation Handbook". Factory-trained representatives are also available locally to aid you. Simply consult a business directory or visit us at *coolair.com* to find an American Coolair representative in your area.

Fan Package Location

Fans should all be at one end of the building. They may be in the end wall or in a sidewall near the end. They should be located so that equipment or stacks of material in the building will not block airflow into the fans. If large doors are going to be kept open in warm weather, fans should be at the opposite end of the building from the doors.

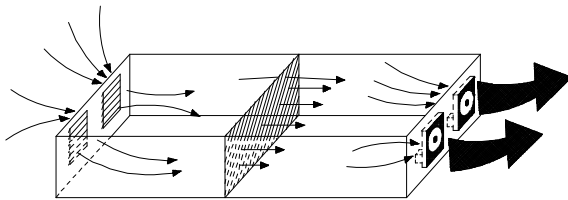

Calculation of Air Volume:

Rate of Air Velocity Method.

This is the method recommended by American Coolair and will provide adequate air movement to produce personnel comfort, not just minimum ventilation.

$$CFM = H \times W \times V$$

Where: **CFM** is air volume in cubic feet per minute
H is the height of the building (ft.)
W is the width of the building (ft.)
V is the desired velocity (see table) (ft./min.)

VELOCITY TABLE

Length of Building	Velocity
Up to 100'	150 ft./min.
100' to 200'	200 ft./min.
200' to 300'	250 ft./min.
300' and longer	250 ft./min plus booster fans

Example: Laundry 100' long by 30' wide by 15' high. Air is to be pulled through the 100' length.

$$CFM = 15' \times 30' \times 150 \text{ ft./min.} = 67,500 \text{ cubic ft./minute}$$

Rate of Air Change Method.

This is the most common method of specifying air volume for small buildings (50,000 cubic feet or less). Rate can be specified for ventilation or personnel comfort.

$$CFM = \frac{H \times W \times L}{R}$$

Where:

CFM is air movement in cubic feet per minute
H is the height of the building (ft.)
W is the width of the building (ft.)
L is the length of the building (ft.)
R is the rate of air change in minutes (see table)

TYPICAL RECOMMENDED AIR CHANGE RATES

Type of Facility	Personnel Comfort	Ventilation
Bakeries, Restaurants, Laundries & other hot spots	1/2 minute	3 minutes
Factories, Shops, Warehouses & Garages	3/4 minute	4 minutes
Residences, Schools, Offices & Churches	1 minute	5 minutes

Example: Laundry 100' long by 30' wide by 15' high — air is to be change to provide personnel comfort:

$$CFM = \frac{15' \times 30' \times 100'}{1/2 \text{ minute}} = 90,000 \text{ cubic ft./minute.}$$

Air Intakes

Provision must be made for air to enter the building. Air intakes should be at the opposite end of the building from the fans so that air movement will occur throughout the building. Wall louvers or roof mounted intakes can be used. Your local American Coolair representative can help you determine what is needed and provide the proper intakes for you.

Sound

Sound ratings may also be a factor in fan selection. These are provided in sones. If additional information is needed, contact your American Coolair representative.

Performance Ratings

Type MB fan ratings shown herein are net performance of complete fan package, including the effects of the shutter, wall housing, and guard. The air and sound performance ratings are based on American Coolair's Type CB fans, which are licensed to bear the AMCA Certified Ratings Seal. BHP does not include drive losses.

Typical Specifications

Belt driven propeller wall fan packages shall be American Coolair Type MBA, MBL, MBH, and MBHX as manufactured by American Coolair Corporation, Jacksonville, Florida; specific models shall be as shown in the fan schedule. Fan packages shall include fan unit, wall housing, (automatic gravity) shutter, and 1 X 1/2" PVC coated inlet guard. Panels and structural angle supports shall be of welded steel construction with spun orifice to provide improved performance (MBL, MBH, & MBHX). Die formed steel blades shall be firmly attached to cast aluminum hub, which also serves as driven sheave. Fan hub shall rotate on fixed shaft using oversized sealed ball bearings. Belt load shall be applied to hub in the same plane as bearings, eliminating overhung load on bearings and increasing bearing life. Motor pulleys shall be variable pitch (except where noted below). (Specify for each fan model in schedule the required CFM and static pressure; motor enclosure, phase and voltage; and accessories such as wall shutter, motor side or front guard, wall housing, etc.)

Item No.	Cubic Feet Per Minute (CFM) at Static Pressure					Fan Model ¹	Fan Size	Motor HP	Fan RPM	Sone Rating ²	Max BHP ³	Approx. Ship Wt.	Shutter Model
	0"	1/8"	1/4"	3/8"	1/2"								
1	2,998	2,822	2,629	2,384	---	MBA18H	18	1/3	1,475	18.0	0.41	110	SU
2	3,421	3,268	3,104	2,926	2,692	MBA18J		1/2	1,683	23.0	0.61	116	SU
3	3,915	3,782	3,642	3,496	3,336	MBA18K		3/4	1,926	27	0.91	130	SU
4	4,356	4,237	4,113	3,985	3,850	MBA18L		1	2,143	32	1.25	135	SU
5	3,082	2,822	2,537	---	---	MBA20G	20	1/4	1,165	13.9	0.31	115	SU
6	3,383	3,147	2,903	---	---	MBA20H		1/3	1,279	16.5	0.40	115	SU
7	3,870	3,664	3,455	3,227	---	MBA20J		1/2	1,463	21.0	0.61	121	SU
8	4,418	4,238	4,055	3,871	3,663	MBA20K		3/4	1,670	26	0.91	135	SU
9	4,910	4,748	4,584	4,420	4,251	MBA20L*		1	1,856	30	1.25	140	SU
10	5,444	5,298	5,151	5,003	4,854	MBA20M*		1 1/2	2,058	36	1.70	162	SU
11	5,010	4,266	---	---	---	MBL24G	24	1/4	702	12.7	0.30	216	LRW
12	5,588	4,950	---	---	---	MBL24H		1/3	783	16.0	0.41	216	LRW
13	6,244	5,691	4,972	---	---	MBL24J		1/2	875	19.8	0.60	219	LRW
14	7,222	6,757	6,199	---	---	MBL24K		3/4	1,012	26	0.90	223	S
15	7,557	7,163	6,697	6,024	5,365	MBH24L*		1	1,065	28	1.25	246	S
16	8,345	7,990	7,599	7,078	6,439	MBH24M*		1 1/2	1,176	33	1.56	248	S
17	6,755	5,346	---	---	---	MBL30G	30	1/4	505	10.4	0.30	276	LRW
18	7,531	6,327	---	---	---	MBL30H		1/3	563	13.0	0.41	276	LRW
19	8,334	7,273	5,696	---	---	MBL30J		1/2	623	16.1	0.60	279	LRW
20	9,725	8,836	7,788	---	---	MBL30K		3/4	727	20	0.90	282	LRW
21	10,713	9,895	8,878	---	---	MBH30L		1	807	25	1.25	290	S
22	11,761	11,027	10,165	9,088	---	MBH30M		1 1/2	886	28	1.70	309	S
23	12,836	12,170	11,420	10,512	9,463	MBH30N		2	967	34	2.25	316	S
24	14,775	14,203	13,584	12,888	12,077	MBH30P*		3	1,113	48	3.31	334	SR
25	8,191	5,894	---	---	---	MBL36G	36	1/4	411	6.8	0.30	349	LRW
26	9,168	7,218	---	---	---	MBL36H		1/3	460	8.3	0.41	349	LRW
27	10,583	9,087	---	---	---	MBL36J		1/2	531	10.1	0.60	352	LRW
28	11,799	10,542	8,631	---	---	MBL36K		3/4	592	13.2	0.90	355	LRW
29	13,314	12,240	10,681	---	---	MBL36L		1	668	15.5	1.25	361	LRW
30	14,197	12,893	11,604	9,702	---	MBH36M		1 1/2	680	20	1.65	385	LRW
31	15,659	14,489	13,310	11,963	10,127	MBH36N		2	750	24	2.25	393	S
32	18,185	17,200	16,144	15,156	13,965	MBH36P		3	871	30	3.35	411	SR
33	21,296	20,474	19,567	18,467	17,847	MBH36Q*		5	1,020	43	5.25	438	SR
34	10,973	7,612	---	---	---	MBL42H		42	1/3	329	8.7	0.41	330
35	12,640	9,957	---	---	---	MBL42J	1/2		379	11.3	0.60	333	LRW
36	14,074	11,694	7,975	---	---	MBL42K	3/4		422	14.0	0.90	336	LRW
37	15,909	13,788	11,384	---	---	MBL42L	1		477	17.4	1.25	343	LRW
38	16,991	15,161	12,957	9,865	---	MBH42M	1 1/2		517	22	1.65	365	LRW
39	18,765	17,132	15,255	12,959	9,429	MBH42N	2		571	25	2.25	373	LRW
40	21,789	20,403	18,883	17,164	15,147	MBH42P	3		663	32	3.34	390	S
41	26,160	25,021	23,812	22,514	21,099	MBH42Q	5		796	44	5.53	417	SR

Item No.	Cubic Feet Per Minute (CFM) at Static Pressure					Fan Model ¹	Fan Size	Motor HP	Fan RPM	Sone Rating ²	Max BHP ³	Approx. Ship Wt.	Shutter Model
	0"	1/8"	1/4"	3/8"	1/2"								
42	15,084	11,079	---	---	---	MBL48J		1/2	315	10.6	0.60	393	LRW
43	17,382	14,225	---	---	---	MBL48K		3/4	363	14.1	0.90	396	LRW
44	19,441	16,686	---	---	---	MBL48L		1	406	16.9	1.25	403	LRW
45	20,722	18,318	14,065	---	---	MBH48M		1 1/2	425	19.6	1.66	431	LRW
46	23,014	20,899	17,851	---	---	MBH48N	48	2	472	23	2.25	438	LRW
47	26,183	24,351	22,184	18,520	---	MBH48P		3	537	29	3.34	455	LRW
48	30,912	29,374	27,734	25,701	22,536	MBH48Q		5	634	37	5.49	482	S
49	34,223	32,795	31,532	30,380	29,241	MBHX48R*		7 1/2	745	49	7.92	780	SR
50	37,531	36,214	35,030	33,944	32,914	MBHX48S*		10	817	57	10.39	812	SR
51	16,433	10,224	---	---	---	MBH54J		1/2	287	11.1	0.60	432	LRW
52	19,239	15,312	---	---	---	MBH54K		3/4	336	14.6	0.91	439	LRW
53	21,529	18,183	---	---	---	MBH54L		1	376	17.6	1.25	446	LRW
54	23,132	20,063	14,165	---	---	MBH54M		1 1/2	404	19.5	1.68	450	LRW
55	25,880	23,172	19,756	---	---	MBH54N	54	2	452	23	2.26	457	LRW
56	29,201	26,824	24,208	19,549	---	MBH54P		3	510	28	3.35	484	LRW
57	35,736	33,713	31,531	28,908	---	MBHX54Q		5	547	33	5.37	775	S
58	41,485	39,756	37,943	35,982	33,671	MBHX54R		7 1/2	635	43	8.39	832	SR
59	45,143	43,560	41,915	40,181	38,269	MBHX54S*		10	691	50	10.71	864	SR
60	25,107	19,853	---	---	---	MBHX60L		1	297	13.0	1.25	759	S
61	27,728	23,068	---	---	---	MBHX60M		1 1/2	328	15.7	1.66	771	S
62	30,264	26,137	21,017	---	---	MBHX60N		2	358	18.2	2.25	775	S
63	34,237	30,775	26,496	---	---	MBHX60P	60	3	405	21	3.19	793	S
64	40,746	37,992	34,490	30,948	---	MBHX60Q		5	482	28	5.40	820	S
65	47,171	44,861	42,092	38,908	35,891	MBHX60R		7 1/2	558	37	8.38	878	S
66	51,989	49,923	47,546	44,758	41,888	MBHX60S		10	615	45	11.04	911	SR

- 1 - The first three or four letters of model number identify **fan type, drive configuration** and **style**. The next two numbers indicate **fan size**; the next letter identifies the motor horsepower. Example; Model MBL24G is Type M, belt drive, Style L, 24" size 1/4 HP.
 - 2 - The sound ratings shown are loudness values in sones at 5 ft. (1.5m) in a hemispherical free field calculated per AMCA standard 301. Values shown are for installation Type A: free inlet fan sone levels. The ratings shown are at 0" static pressure.
 - 3 - Maximum brake horsepower (BHP) within the catalog performance range. BHP does not include belt drive losses. Bearing losses are included. BHP at most static pressures listed is less than shown, in some cases, substantially less. For specific BHP values at individual static pressure points, contact your American Coolair representative. Because of the cooling the motor receives from the moving airstream, motor loading beyond the nominal nameplate rating on these American Coolair fans does not overheat the motor and is within NEMA recommended limits and motor service factor. It is not detrimental to the motor and is economically desirable.
- * - These models use fixed pitch motor pulleys.

To convert air performance (CFM and SP) and power (BHP) to metric units, multiply CFM x .000472 to obtain cubic meters per second (CMS). Multiply SP x 248.36 to obtain Pascals (Pa). Multiply BHP x .7457 to obtain Kilowatts (kW).

Example: 3904 CFM x .000472 = 1.8427 CMS
0.125 SP x 248.36 = 31.05 Pa
0.886 BHP x .7457 = 0.661 kW

Standard MB Fan Package

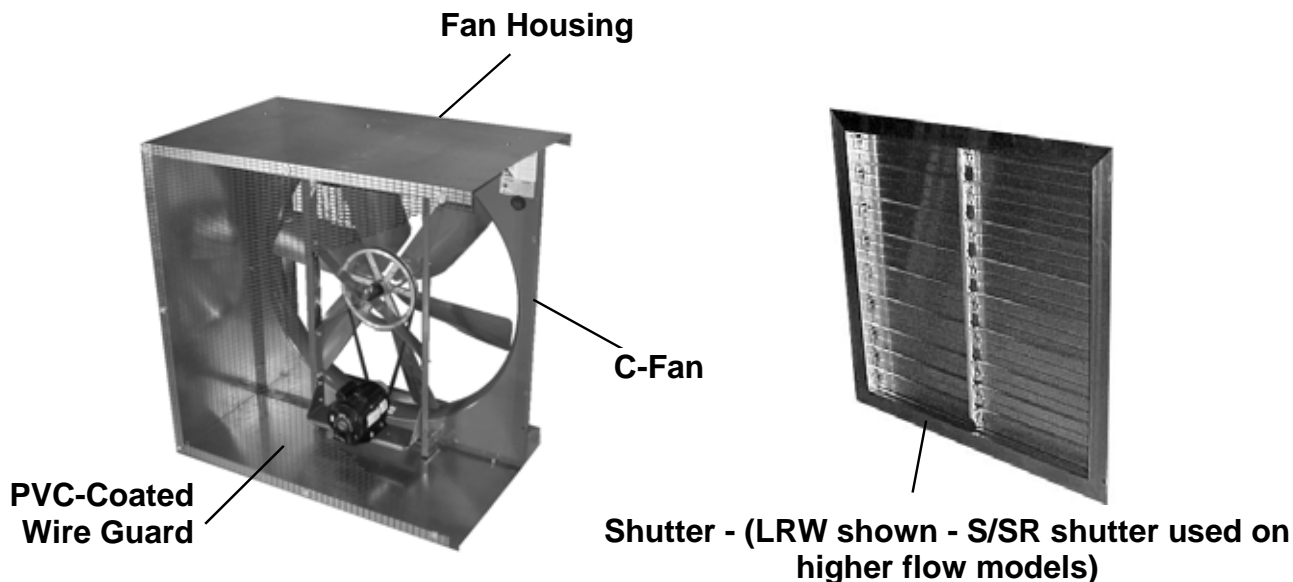

Accessories for MB Fan Packages



INLET HOOD OPTION

- Specifically designed for supply applications
- Designed to prevent entrainment of moisture into the airstream
- Hardware kit included for ease of assembly
- PVC-coated wire guard available
- Wide range of sizes to fit every need

DISCHARGE HOOD OPTION

- Specifically designed for exhaust applications
- Designed for all-weather performance with minimal pressure losses
- Hardware kit included for ease of assembly
- PVC-coated wire guard available
- Wide range of sizes to fit every need



Spark-Resistant Construction

For hazardous locations, MBL and MBH fan packages can be ordered with a non-ferrous blade assembly and explosion proof motor. **Motors only** qualify for Class I Group D and Class II Groups F & G hazards.

Protective Coatings

For most applications, the American Coolair thermosetting epoxy powder coating system will provide the necessary surface protection for painted parts. For applications that require more specialized surface protection, American Coolair offers alternatives such as 6 mil epoxy coating or hot dip galvanizing. For more information about special protective coatings, contact your American Coolair representative.

Shutter Bird Guard

Guard made of PVC-coated steel wire with $\frac{1}{2}$ " x 1" spacing protects shutter from damage by birds or vandalism. Attaches flat against shutter face giving an attractive appearance (requires Type S or SR shutter).

Mounting Flanges

Galvanized steel mounting flanges can be used for mounting an inlet hood or a discharge hood to the wall. They can also be used to mount the fan housing to the wall if the fan housing is extending through the wall. A hardware kit for installation is included.

Type MB Fan Package and Accessory Dimensions

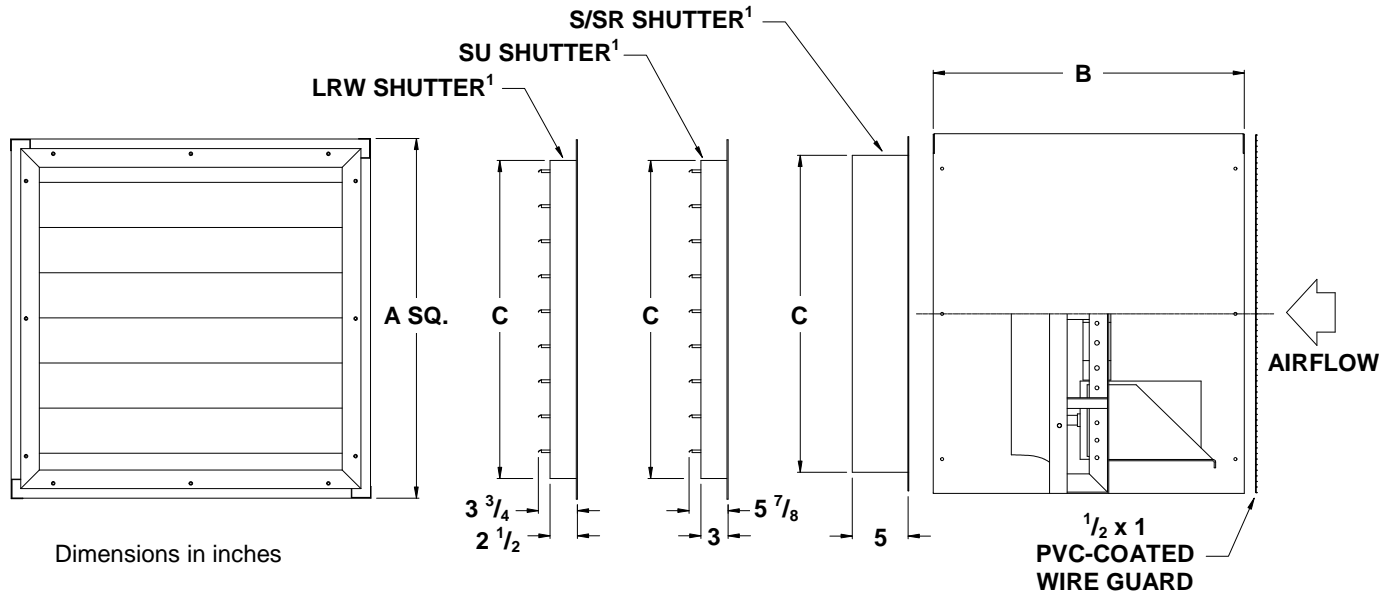

Fan Size	Dimensions in Inches									
	A	B	C ¹		D	E	F	G	Square Wall Opening	
			LRW	S/SR/SU					Shutter ² Clearance	Housing ³ Clearance
18, 20	26 1/4	25 3/8	—	22 1/4	19	26 1/2	27 1/2	29 1/2	22 3/4	27
24	32 1/4	26 7/8	27	28 3/8	22	32 1/2	33 1/2	35 3/8	28 7/8	33
30	38 1/4	26 7/8	33	34 3/8	24 5/8	38 1/2	39 1/2	41 3/8	34 7/8	39
36	44 1/4	32 5/8	39	40 3/8	27 5/8	44 1/2	45 1/2	47 3/8	40 7/8	45
42	50 1/4	32 5/8	45	46 3/8	30 1/4	50 1/2	51 1/2	53 3/8	46 7/8	51
48	56 3/8	32 5/8	51	52 3/8	32 7/8	56 1/2	57 1/2	59 1/2	52 7/8	57 1/8
54	62 3/8	32 5/8	57	58 3/8	35 3/4	62 1/2	63 1/2	65 5/8	58 7/8	63 1/8
60	68 3/8	32 5/8	—	64 3/8	35 3/4	68 1/2	69 1/2	71 5/8	64 7/8	69 1/8

Dimension A is the OD of the square wall housing, including hardware.

Dimension B is the length of the wall housing.

Dimension C is the OD of the shutter frame.

Dimension D is the overall length of the discharge hood.

Dimension E is the overall height of both the discharge and inlet hood.

Dimension F is the overall length of the inlet hood.

Dimension G is the overall height of the mounting flanges.

- 1 - LRW shutter used on most models. S/SR shutter used on higher flow models. SU shutter used on all MBA models. See Pages 4 & 5 for shutter usage by fan model.
- 2 - "Shutter Clearance" Wall Opening Dimension is for metal building installations only. Opening allows for shutter frame only to protrude to the outside.
- 3 - "Housing Clearance" Wall Opening Dimension is for installations where the MB package is to be recessed into a wall.

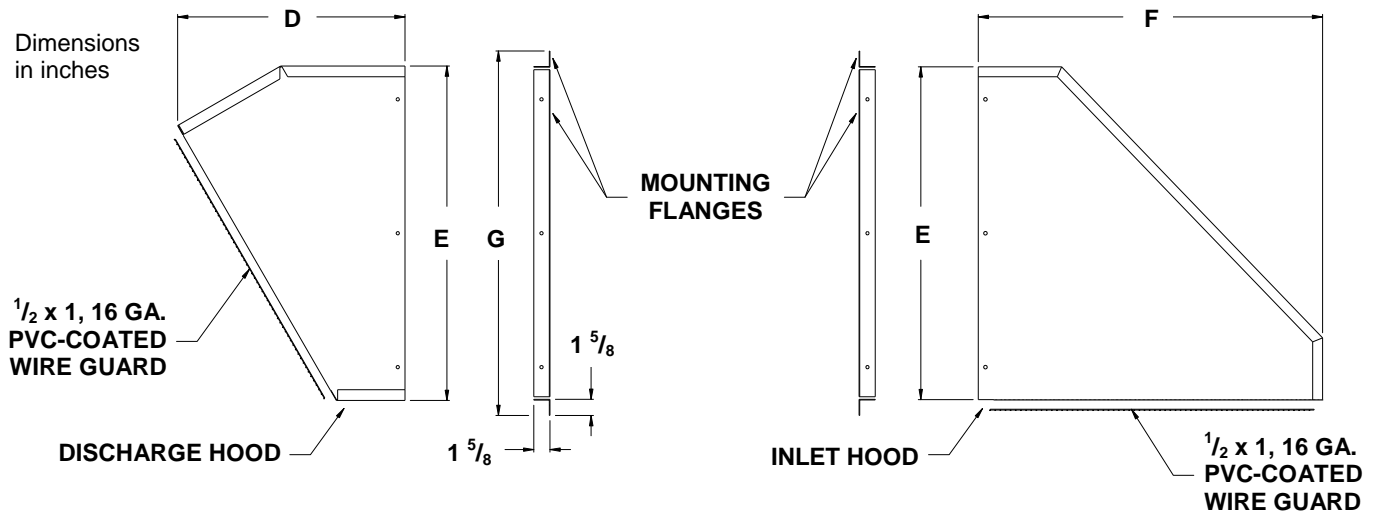

Installation and Maintenance

Installation: Type MB fan packages are shipped completely assembled with shutter, housing, fan and guard for quick, easy installation. Installation and maintenance instructions are included.

- Place the fan package on a supporting girt, on the inside of the building, and push the fan package against the outside skin.
- Cut an opening in the building panel slightly larger than the shutter frame and smaller than the fan housing (See dimensions on Page 7).
- Push the shutter through the opening.
- Attach two pieces of angle (supplied by others), one on either side of the fan housing, from the support girt to the girt above (See Figure 1).
- Fasten the fan housing to the angle with 6 self-drilling, sheet metal screws (3 per side).
- Attach the building panel to the fan housing above the shutter.
- Flash and caulk around the shutter opening to suit the building panel.
- All electrical connections should be made by a licensed electrician.

Maintenance: Type MB fan packages should be cleaned as necessary to remove accumulated dust, dirt and other foreign matter which may collect on blades or other fan package parts.

Fan belt should be inspected and tension adjusted after the first 8-10 hours of fan operation and periodically thereafter. Check belt for proper alignment.

Fan bearings are permanently lubricated. For lubrication of electric motor, see instructions supplied by the motor manufacturer.

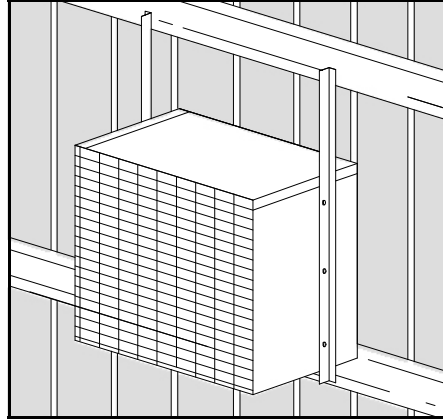

Fig. 1

Limited Warranty

In the sale of its products, American Coolair Corporation agrees to correct, by repairs or replacement, any defects in workmanship or material that may develop under proper and normal use during the period of one year from the date of shipment from the factory. Any product or part proving, upon American Coolair's examination, to be defective during limited warranty period will be repaired or replaced, at American Coolair's option, f.o.b. factory, without charge.

Deterioration or wear caused by chemicals, abrasive action or excessive heat shall not constitute defects.

Motors are guaranteed only to the extent of the manufacturer's warranty.

American Coolair's limited warranty does not apply to any of its products or parts that have been subject to accidental damage, misuse by the user, unauthorized alterations, improper installation or electrical wiring, or lack of proper lubrication or other service requirements as established by American Coolair.

Repairs or replacements provided under the above terms shall constitute fulfillment of all American Coolair's obligations with respect to limited warranty.

THE LIMITED WARRANTY STATED HEREIN IS IN LIEU OF ALL OTHER WARRANTIES, EXPRESS, STATUTORY OR IMPLIED, INCLUDING WITHOUT LIMITATION THAT OF MERCHANTABILITY AND FITNESS.

NO LIABILITY FOR REINSTALLATION COST OR FOR ANY SPECIAL, INDIRECT OR CONSEQUENTIAL DAMAGES OF ANY NATURE IS ASSUMED OR SHALL BE IMPOSED UPON AMERICAN COOLAIR.

WARNING

CAUTION



DO NOT INSTALL FAN WITH MOVING PARTS WITHIN 8 FEET OF FLOOR OR GRADE LEVEL WITHOUT A GUARD THAT COMPLIES WITH OSHA REGULATIONS. **DO NOT** USE UNLESS ELECTRICAL WIRING COMPLIES WITH ALL APPLICABLE CODES. **DO NOT** WIRE WITHOUT PROVIDING FOR A POWER SOURCE DISCONNECT AT THE FAN ITSELF. **DO NOT** SERVICE EXCEPT BY A QUALIFIED MAINTENANCE TECHNICIAN AND ONLY AFTER DISCONNECTING THE POWER SOURCE. FAILURE TO OBSERVE THESE PRECAUTIONS CAN RESULT IN SERIOUS INJURY OR DEATH.



Represented By:

AMERICAN COOLAIR CORPORATION

PO BOX 2300, JACKSONVILLE, FL 32203

Phone: (904) 389-3646

Fax: (904) 387-3449

E-mail: fans@coolair.com

Website: www.coolair.com