

**SPLIT TYPE
ROOM AIR CONDITIONER
FLOOR type
INVERTER**

SERVICE INSTRUCTION

Models	Indoor unit	Outdoor unit
	AGU9RLF	AOU9RLFF
	AGU12RLF	AOU12RLFF
	AGU15RLF	AOU15RLFF

Refrigerant
R410A

CONTENTS

1. DESCRIPTION OF EACH CONTROL OPERATION

1. COOLING OPERATION.....	01-01
2. HEATING OPERATION.....	01-02
3. DRY OPERATION.....	01-02
4. AUTO CHANGEOVER OPERATION.....	01-03
5. INDOOR FAN CONTROL.....	01-04
6. OUTDOOR FAN CONTROL.....	01-06
7. LOUVER CONTROL.....	01-07
8. COMPRESSOR CONTROL.....	01-08
9. TIMER OPERATION CONTROL.....	01-09
10. ELECTRONIC EXPANSION VALVE CONTROL.....	01-12
11. TEST OPERATION CONTROL.....	01-12
12. PREVENT TO RESTART FOR 3 MINUTES (3 MINUTES ST).....	01-12
13. FOUR-WAY VALVE EXTENSION SELECT.....	01-12
14. AUTO RESTART.....	01-13
15. MANUAL AUTO OPERATION (Indoor unit body operation).....	01-13
16. FORCED COOLING OPERATION (TEST OPERATION).....	01-13
17. COMPRESSOR PREHEATING.....	01-14
18. MIN. (MINIMUM) HEAT OPERATION.....	01-14
19. ECONOMY OPERATION.....	01-14
20. POWERFUL OPERATION.....	01-14
21. DEFROST OPERATION CONTROL.....	01-15
22. OFF DEFROST OPERATION CONTROL.....	01-17
23. AIR OUTLET SELECTION (DAMPER CONTROL).....	01-18
24. VARIOUS PROTECTIONS.....	01-20

2. TROUBLE SHOOTING

2-1 ERROR DISPLAY.....	02-01
2-1-1 INDOOR UNIT AND WIRED REMOTE CONTROLLER DISPLAY.....	02-01
2-1-2 WIRED REMOTE CONTROLLER DISPLAY(OPTION).....	02-02
2-2 TROUBLE SHOOTING WITH ERROR CODE.....	02-03
2-3 TROUBLE SHOOTING WITH NO ERROR CODE.....	02-26
2-4 SERVICE PARTS INFORMATION.....	02-31

3. APPENDING DATA

3-1 FUNCTION SETTING.....	03-01
3-1-1 INDOOR UNIT.....	03-01
3-1-2 Procedures to change the Function Setting for wireless RC.....	03-03
3-2 Thermistor Resistance Values.....	03-05
3-2-1 INDOOR UNIT.....	03-05
3-2-2 OUTDOOR UNIT.....	03-05

FLOOR type INVERTER

1 . DESCRIPTION OF EACH CONTROL OPERATION

1. COOLING OPERATION

A sensor (room temperature thermistor) built in the indoor unit body will usually perceive difference or variation between a set temperature and present room temperature, and controls the operation frequency of the compressor.

* If the room temperature is 4°F(2°C) higher than a set temperature, the compressor operation frequency will attain to maximum performance.

* If the room temperature is 5°F(2.5°C) lower than a set temperature, the compressor will be stopped.

* When the room temperature is between +4°F(+2°C) to -5°F(-2.5°C) of the setting temperature, the compressor frequency is controlled within the range shown in Table 1.

However, the maximum frequency is limited in the range shown in Fig. 1 based on the fan speed mode and the outdoor temperature.

(Table 1 : Compressor frequency range)

	Air flow	Minimum frequency	Maximum frequency I	Maximum frequency II
AOU9RLFF AOU12RLFF	Upper & Lower	10rps	76rps	57rps
	Upper			
AOU15RLFF	Upper & Lower	12rps	91rps	56rps
	Upper			

When the compressor operates for 30 minutes continuously at over the maximum frequency II, the maximum frequency is changed from Maximum Frequency I to Maximum Frequency II.

(Fig.1 : Outdoor temperature zone)

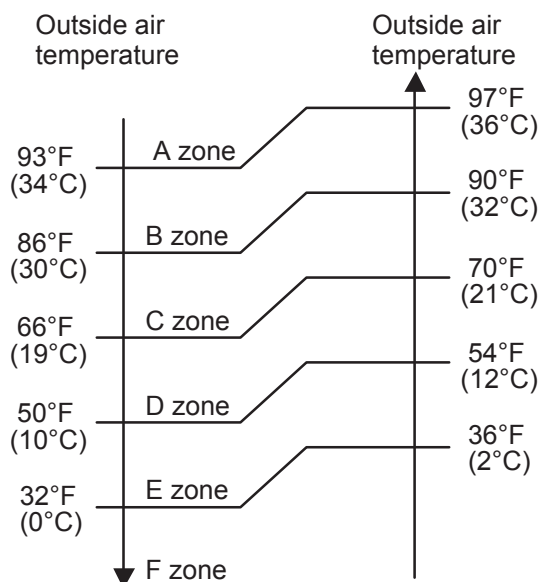

(Table 2 : Limit of maximum speed based on outdoor temperature)

AOU9/12RLFF

	Outdoor temp. zone	Indoor fan mode			
		Hi	Me	Lo	Quiet
Upper & Lower air flow	A zone	76rps	45rps	37rps	29rps
	B zone	76rps	45rps	37rps	29rps
	C zone	76rps	45rps	37rps	26rps
	D zone	43rps	35rps	26rps	20rps
	E zone	51rps	37rps	31rps	22rps
	F zone	51rps	37rps	31rps	22rps
Upper air flow	A zone	76rps	45rps	37rps	29rps
	B zone	76rps	45rps	37rps	29rps
	C zone	76rps	45rps	37rps	26rps
	D zone	43rps	35rps	26rps	20rps
	E zone	51rps	37rps	31rps	22rps
	F zone	51rps	37rps	31rps	22rps

AOU15RLFF

	Outdoor temp. zone	Indoor fan mode			
		Hi	Me	Lo	Quiet
Upper & Lower air flow	A zone	91rps	44rps	34rps	24rps
	B zone	91rps	44rps	34rps	24rps
	C zone	72rps	44rps	34rps	24rps
	D zone	52rps	30rps	21rps	18rps
	E zone	62rps	34rps	27rps	19rps
	F zone	62rps	34rps	27rps	19rps
Upper air flow	A zone	91rps	44rps	34rps	24rps
	B zone	91rps	44rps	34rps	24rps
	C zone	72rps	44rps	34rps	24rps
	D zone	52rps	30rps	21rps	18rps
	E zone	62rps	34rps	27rps	19rps
	F zone	62rps	34rps	27rps	19rps

2. HEATING OPERATION

A sensor (room temperature thermistor) built in the indoor unit body will usually perceive difference or variation between a set temperature and present room temperature, and controls the operation frequency of the compressor.

- * If the room temperature is lower by 6°F(3°C) than a set temperature, the compressor operation frequency will attain to maximum performance.
- * If the room temperature is higher 5°F(2.5°C) than a set temperature, the compressor will be stopped.
- * When the room temperature is between +5°F(+2.5°C) to -6°F(-3°C) of the setting temperature, the compressor frequency is controlled within the range shown in Table 3.

(Table 3 : Compressor frequency range)

	Air flow	Minimum frequency	Maximum frequency
AOU9RLFF	Upper & Lower	16rps	119rps
AOU12RLFF	Upper		
AOU15RLFF	Upper & Lower	16rps	140rps
	Upper		

3. DRY OPERATION

The compressor frequency shall change according to the temperature, set temperature, and room temperature variation which the room temperature sensor of the indoor unit body has detected as shown in the Table 4.

However, after the compressor is driven, the outdoor unit shall run at operation frequency of 51rps (9RLFF), 51rps (12RLFF), 52rps (15RLFF) for a minute.

(Table 4 : Compressor frequency in Dry mode)

		Operating frequency			Operating frequency			Operating frequency
AOU 9RLFF	X zone	26rps	AOU 12RLFF	X zone	26rps	AOU 15RLFF	X zone	24rps
	J zone	18rps		J zone	18rps		J zone	16rps
	Y zone	0rps		Y zone	0rps		Y zone	0rps

(Fig.2 : Compressor Control based on Room Temperature)

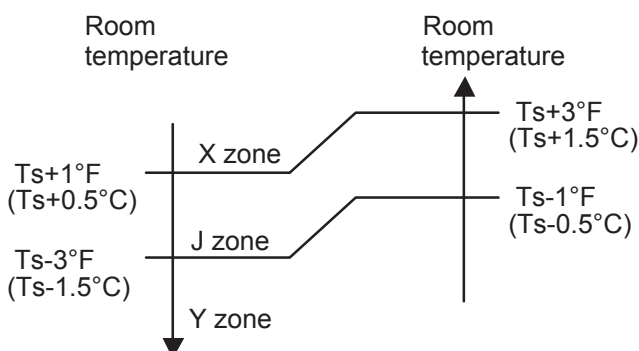

4. AUTO CHANGEOVER OPERATION

When the air conditioner is set to the AUTO mode by remote control, operation starts in the optimum mode from among the HEATING, COOLING, DRY and MONITORING modes. During operation, the optimum mode is automatically switched in accordance with temperature changes. The temperature can be set between 64°F(18°C) and 88°F(30°C) in 2°F(1°C) steps.

(Fig3 : Operation flow chart)

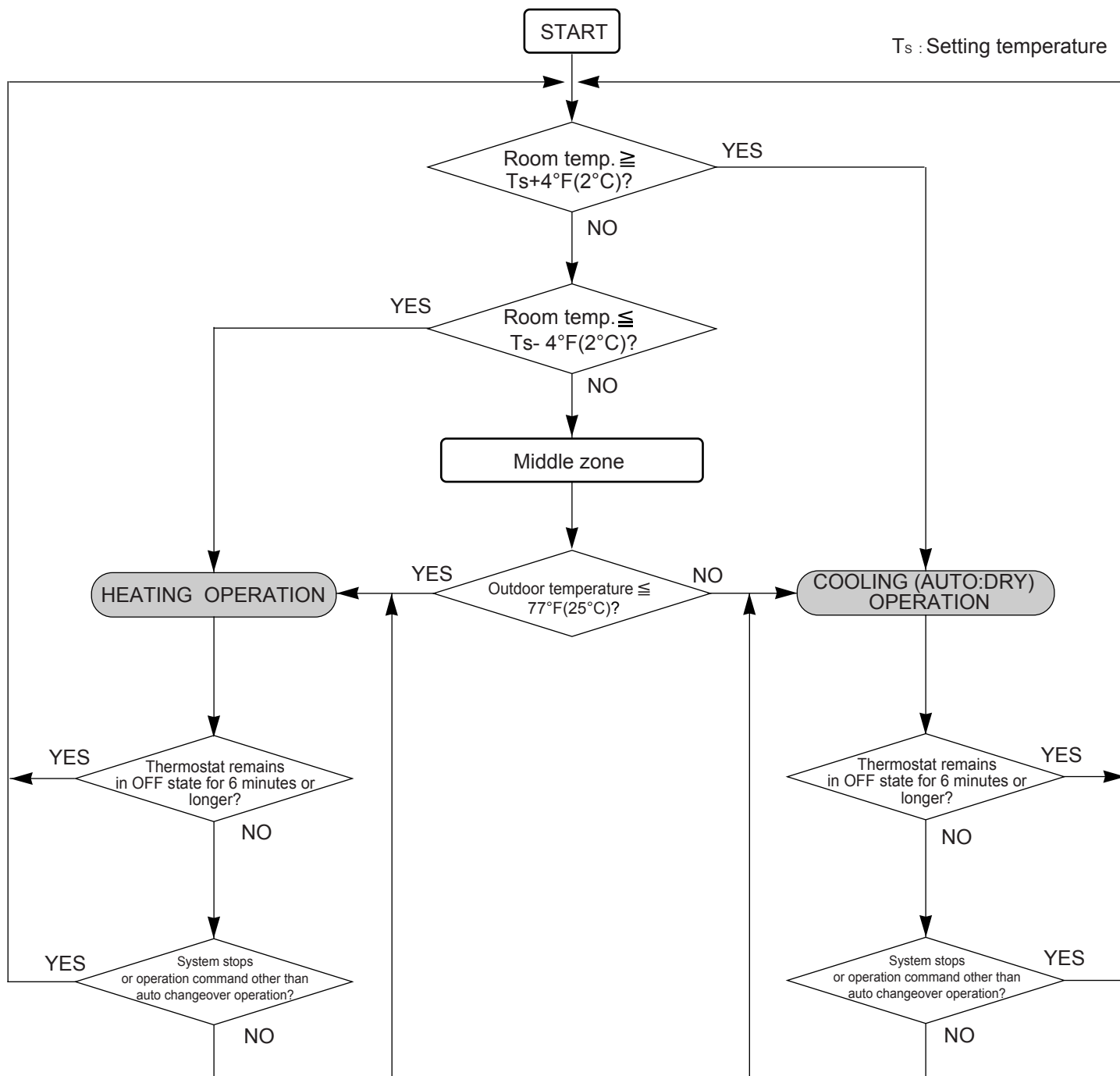

5. INDOOR FAN CONTROL

1. Fan speed

(Table 5 : Indoor fan speed)

AGU9/ 12RLF

Operation mode	Air flow mode		Speed (rpm)	
			Upper& Lower air flow mode	Upper air flow mode
Heating	Powerful	(Upper/ Lower)	1350/ 1150	1350/ ---
	Hi		1240/ 1040	1280/ ---
	Me		1040/ 880	1080/ ---
	Lo		840/ 700	870/ ---
	Quiet		660/ 560	680/ ---
	Cool air prevention		660/ 560	680/ ---
Cooling/ Fan	Powerful	(Upper/ Lower)	1300/ 1100	1300/ ---
	Hi		1190/ 1000	1230/ ---
	Me		1000/ 850	1030/ ---
	Lo		820/ 690	850/ ---
	Quiet		660/ 560	680/ ---
	S-Lo		660/ 560	680/ ---
Dry		(Upper/ Lower)	---- / ----	X zone: 680 J zone: 680

AGU15RLF

Operation mode	Air flow mode		Speed (rpm)	
			Upper& Lower air flow mode	Upper air flow mode
Heating	Powerful	(Upper/ Lower)	1440/ 1230	1440/ ---
	Hi		1330/ 1120	1370/ ---
	Me		1100/ 930	1130/ ---
	Lo		860/ 730	890/ ---
	Quiet		660/ 560	680/ ---
	Cool air prevention		660/ 560	680/ ---
Cooling/ Fan	Powerful	(Upper/ Lower)	1440/ 1230	1440/ ---
	Hi		1330/ 1120	1370/ ---
	Me		1100/ 930	1130/ ---
	Lo		890/ 750	890/ ---
	Quiet		660/ 560	680/ ---
	S-Lo		660/ 560	680/ ---
Dry		(Upper/ Lower)	---- / ----	X zone: 680 J zone: 680

2. FAN OPERATION

The airflow can be switched in 5 steps such as Auto, Quiet, Lo, Me, Hi, while the indoor fan only runs. When fan mode is set at [Auto], it operates on [Me] fan Speed.

3. COOLING OPERATION

Switch the airflow [Auto], and the indoor fan motor will run according to a room temperature, as shown in Fig4.

On the other hand, if switched in [Hi]~[Quiet], the indoor motor will run at a constant airflow of [Cool] operation modes Quiet, Lo, Me, Hi, as shown in Table 5.

(Fig.4 : Airflow change - over (Cooling : Auto))

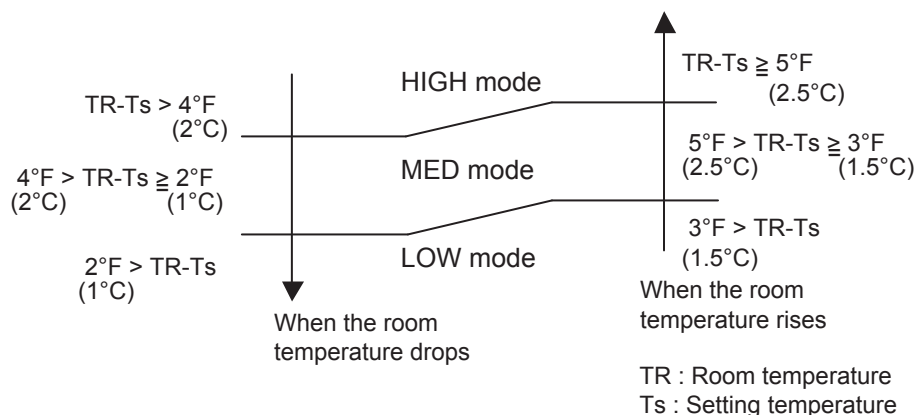

5. HEATING OPERATION

Switch the airflow [Auto], and the indoor fan motor will run according to a room temperature, as shown in Fig. 5

On the other hand, if switched in [Hi] ~ [Quiet], the indoor motor will run at a constant airflow of [Heat] operation modes Quiet, Lo, Me, High, as shown in Table 5.

(Fig. 5 : Airflow change - over (Heating : Auto))

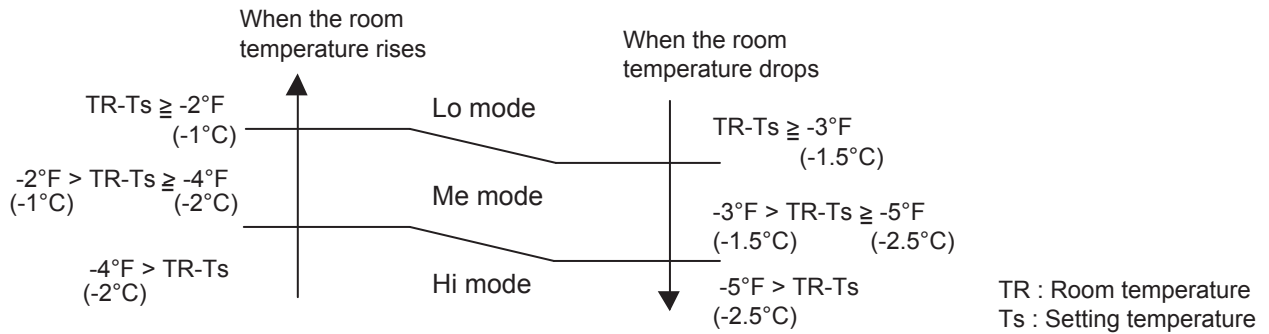

6. COOL AIR PREVENTION CONTROL (Heating mode)

The maximum value of the indoor fan speed is set as shown in Fig. 6 based on the detected temperature by the indoor heat-exchanger sensor on heating mode.

(Fig. 6 : Cool air prevention control)

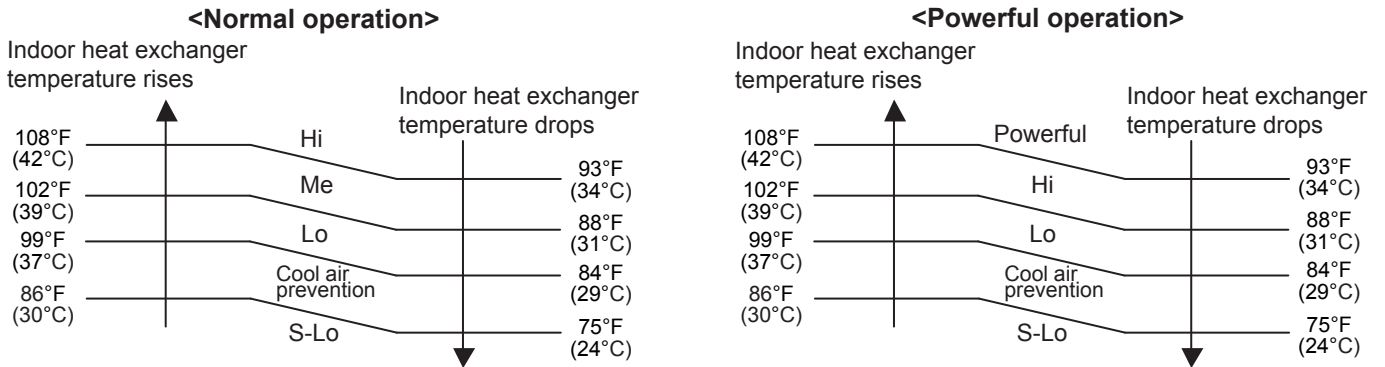

7. MOISTURE RETURN PREVENTION CONTROL (Cooling mode & Dry mode)

Switch the airflow [Auto] at cooling mode, and the indoor fan motor will run as shown in Fig. 7.

(Fig. 7 : Indoor fan control)

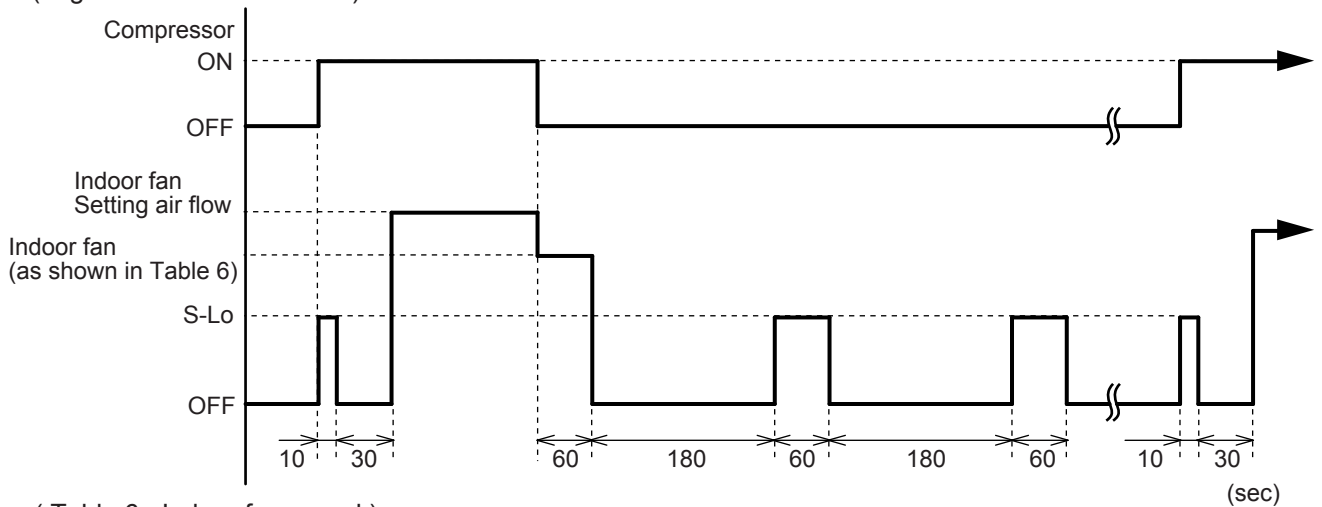

(Table 6 : Indoor fan speed)

	Dry		Cooling
	X zone	J zone	
AGU9 /12RLF /15RLF	680rpm	680rpm	680rpm

6. OUTDOOR FAN CONTROL

1. Outdoor Fan Motor

The Table 7 shows the type of the outdoor fan motor. The control method is different between AC motor and DC motor.

(Table 7 : Type of Motor)

	AC Motor	DC Motor
AOU9 / 12 / 15RLFF		○

2. Fan Speed

(Table 8 : Outdoor fan speed)

	Zone ※	Cooling	Heating	Dry
AOU9RLFF	Y	1050/ 870/ 720/ 590/ 530	1100/ 870/ 780/ 720/ 590/ 480	530
	Z	300		
	F	300/ 250		
	G	250/ 200		
AOU12RLFF	Y	1050/ 870/ 720/ 590/ 530	1100/ 870/ 780/ 720/ 590/ 480	530
	Z	870/530/300		
	F	300/ 250		
	G	250/ 200		
AOU15RLFF	Y	1050/ 870/ 720/ 530	1100/ 1000/ 780/ 720/ 590/ 480	530
	Z	870/ 530/ 300		
	F	300		
	G	250/ 200		

※ Refer to Fig. 8

(Fig. 8 : Outside air temperature zone selection)

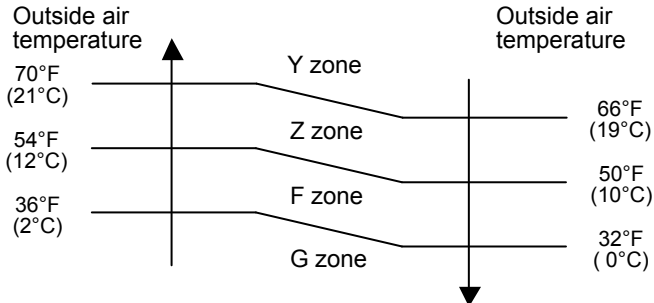

- * The outdoor fan speed mentioned above depends on the compressor frequency. (When the compressor frequency increases, the outdoor fan speed also changes to the higher speed. When the compressor frequency decreases, the outdoor fan speed also changes to the lower speed.)
- * After the defrost control is operated on the heating mode, the fan speed keeps at the higher speed as Table 9 without relating to the compressor frequency.

(Table 9 : Outdoor fan speed after the defrost)

AOU9RLFF	1100rpm
AOU12RLFF	1100rpm
AOU15RLFF	1100rpm

7. LOUVER CONTROL

1. VERTICAL LOUVER CONTROL

(Function and Operation Range)

Each time the button is pressed, the air direction range will change as follows:

① ⇄ ② ⇄ ③ ⇄ ④ ⇄ ⑤

The Remote controller's display does not change.

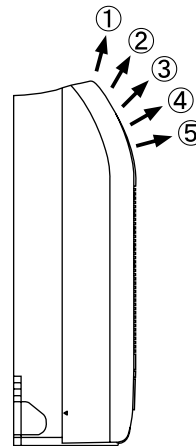

(Fig 9: Air Direction Range)

- Use the air direction adjustments within the ranges shown above.
- The vertical airflow direction is set automatically as shown, in accordance with the type of operation selected.
 - Cooling / Dry mode : Horizontal flow ①
 - Heating mode : Downward flow ④
- During AUTO mode operation, for the first minute after beginning operation, airflow will be upward ① ; the air direction cannot be adjusted during this period.
- During Heating mode operation, airflow will be upward ① when the temperature of the air issued from the indoor is low.

2. ADJUST THE RIGHT-LEFT LOUVERS

- Move the Right-Left louvers to adjust airflow in the direction you prefer.

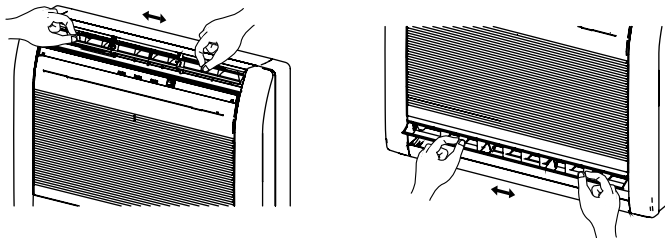

3. SWING OPERATION

To select Vertical Airflow Swing Operation

- When the swing signal is received from the remote controller, the vertical louver starts to swing.
(Swinging Range)

① ⇄ ⑤

- When the indoor fan is either at S-lo or Stop mode, the swinging operation is interrupted and the louver stops at the memorized position.

To select Horizontal Airflow Swing Operation

(No function)

8. COMPRESSOR CONTROL

1. OPEARTION FREQUENCY RANGE

The operation frequency of the compressor is different based on the operation mode as shown in the Table 10.

(Table 10 : Compressor frequency range)

	Cooling		Heating		Dry	
	Minimum	Maximum	Minimum	Maximum	Minimum	Maximum
AOU9/ 12RLFF	10rps	76rps	16rps	119rps	18rps	26rps
AOU15RLFF	12rps	91rps	16rps	140rps	16rps	24rps

2. OPEARTION FREQUENCY CONTROL AT NORMAL START UP

The compressor frequency soon after the start-up is controlled as shown in the Fig.10

(Fig.10 : Compressor control at start-up)

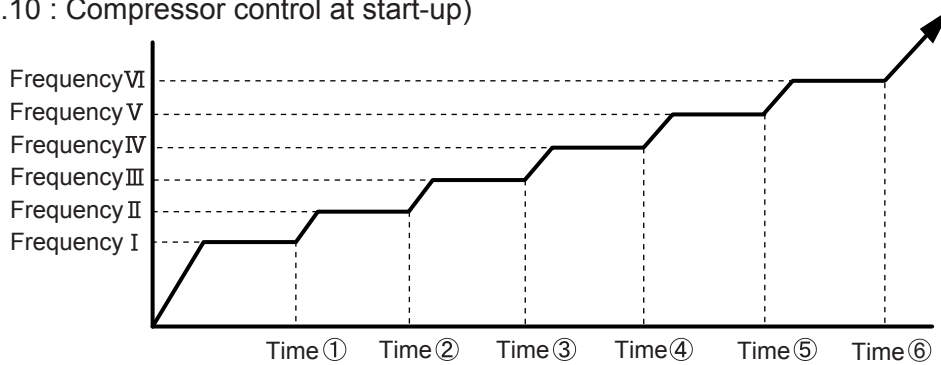

(Frequency)

	Frequency I	Frequency II	Frequency III	Frequency IV	Frequency V	Frequency VI
AOU9/ 12RLFF	40rps	57rps	72rps	80rps	101rps	110rps
AOU15RLFF	40rps	59rps	72rps	80rps	101rps	110rps

(Time)

	Time ①	Time ②	Time ③	Time ④	Time ⑤	Time ⑥
AOU9/ 12 / 15RLFF	80sec	110sec	140sec	200sec	350sec	410sec

3. LIMITATION OF COMPRESSOR FREQUENCY BY OUTDOOR TEMPERATURE

The minimum compressor frequency is limited by outdoor temperature as shown in the Table11.

(Table11 : Limitation of Compressor Frequency)

[Cooling/ Dry]

	50°F (10°C)		59°F (14°C)		104°F (40°C)	
	Under	Over	Under	Over	Under	Over
AOU9/ 12RLFF	35rps	18rps	10rps	10rps		

	32°F (0°C)		50°F (10°C)		104°F (40°C)	
	Under	Over	Under	Over	Under	Over
AOU15RLFF	24rps	18rps	12rps	16rps		

[Heating]

	-4°F (-20°C)		5°F (-15°C)		23°F (-5°C)		37°F (3°C)		45°F (7°C)		104°F (40°C)	
	Under	Over	Under	Over	Under	Over	Under	Over	Under	Over	Under	Over
AOU9/ 12RLFF	35rps	35rps	35rps	29rps	18rps	16rps	16rps					

	-4°F (-20°C)		5°F (-15°C)		23°F (-5°C)		37°F (3°C)		45°F (7°C)		104°F (40°C)	
	Under	Over	Under	Over	Under	Over	Under	Over	Under	Over	Under	Over
AOU15RLFF	24rps	24rps	24rps	24rps	18rps	16rps	16rps					

9. TIMER OPEARTION CONTROL

9-1 WIRELESS REMOTE CONTROLLER

The Table 12 shows the available timer setting based on the product model.

(Table 12 : Timer Setting)

	ON TIMER / OFF TIMER	PROGRAM TIMER	SLEEP TIMER
AGU9/ 12/ 15RLF	○	○	○

1. OPEARTION FREQUENCY RANGE

- OFF timer : When the clock reaches the set time, the air conditioner will be turned off.

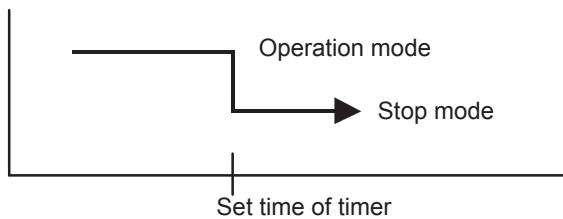

- ON timer : When the clock reaches the set time, the air conditioner will be turned on.

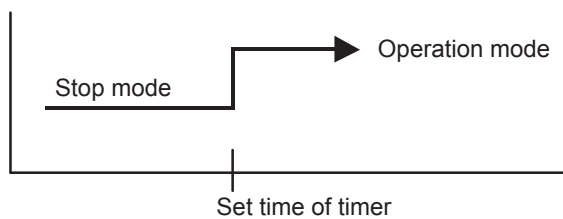

2. PROGRAM TIMER

- The program timer allows the OFF timer and ON timer to be used in combination one time.

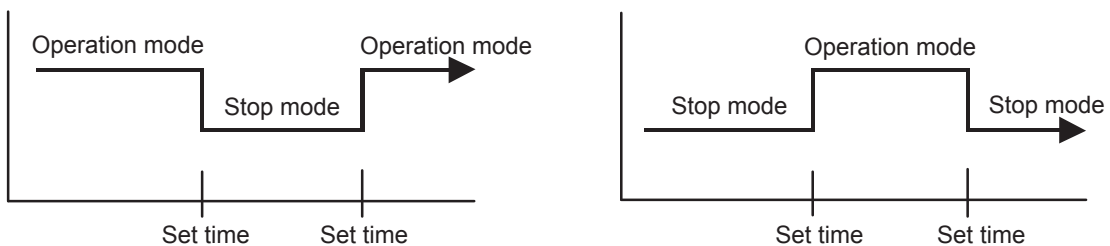

- Operation will start from the timer setting (either OFF timer or ON timer) whichever is closest to the clock's current timer setting.
The order of operations is indicated by the arrow in the remote control unit's display.

- SLEEP timer operation cannot be combined with ON timer operation.

3. SLEEP TIMER

If the sleep is set, the room temperature is monitored and the operation is stopped automatically. If the operation mode or the set temperature is change after the sleep timer is set, the operation is continued according to the changed setting of the sleep timer from that time ON.

In the cooling operation mode

When the sleep timer is set, the setting temperature is increased 2°F(1°C). It increases the setting temperature another 2°F(1°C) after 1 hour. After that, the setting temperature is not changed and the operation is stopped at the time of timer setting.

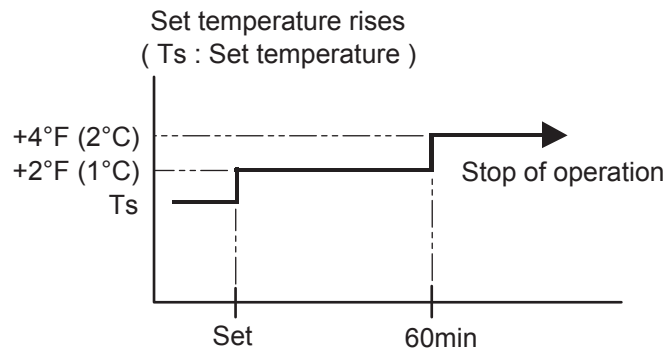

In the heating operation mode

When the sleep timer is set, the setting temperature is decreased 2°F(1°C). It decreases the setting temperature another 2°F(1°C) every 30 minutes. Upon lowering 8°F(4°C) the setting temperature is not changed and the operation stops at the time of timer setting.

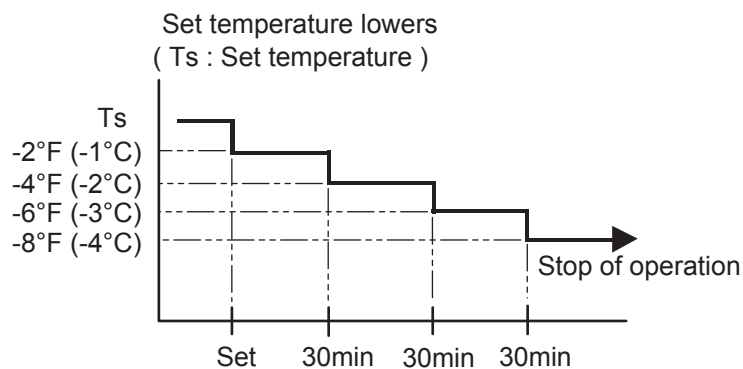

9-2 WIRED REMOTE CONTROLLER (OPTION)

The Table 13 shows the available timer setting based on the product model.

(Table 13 : Timer Setting)

	ON TIMER / OFF TIMER	WEEKLY TIMER	TEMPERATURE SET BACK TIMER
AGU9/ 12/ 15RLF	○	○	○

1. ON TIMER / OFF TIMER

Same to 9-1 1.ON TIMER / OFF TIMER and shown in those.

2. WEEKLY TIMER

This timer function can set operation times of the each day of the week.

All days can be set together, the weekly timer can be used to repeat the timer setting for all of the days.

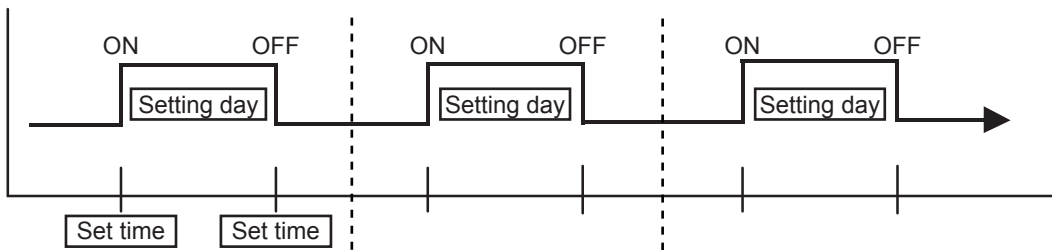

3. TEMPERATURE SET BACK TIMER

This timer function can change setting temperature of setting operation times of the each day of the week.

This can be together with other timer setting.

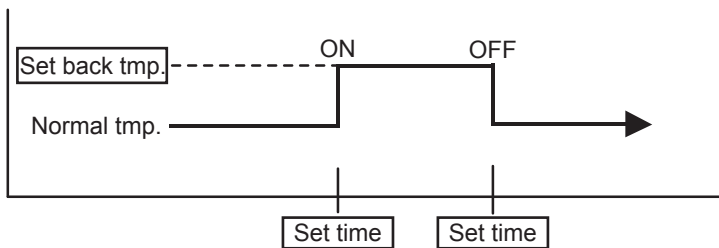

10. ELECTRONIC EXPANSION VALVE CONTROL

The most proper opening of the electronic expansion valve is calculated and controlled under the present operating condition based on the Table 14.

The compressor frequency, the detected temperature by the discharge temperature sensor, the indoor heat exchanger sensor, the outdoor heat exchanger sensor, and the outdoor temperature sensor.

(Table 14 : The pulse range of the electronic expansion valve control)

	Operation mode	Pulse range
AOU9RLFF AOU12RLFF	Cooling / Dry mode	Between 60 to 480 pulses.
	Heating mode	Between 45 to 480 pulses.
AOU15RLFF	Cooling / Dry mode	Between 60 to 480 pulses.
	Heating mode	

- * The expansion valve is set at 480 pulses 110seconds after the compressor had stopped.
- * Initialization will start after 24 hours pass from the last initialization, and the compressor stops
- * At the time of supplying the power to the outdoor unit, the initialization of the electronic expansion valve is operated (528 pulses are input to the closing direction).

11. TEST OPERATION CONTROL

[Operation method]

The outdoor unit, may not operate, depending on the room temperature.

In this case, keep on pressing the MANUAL AUTO button of the indoor unit for more than 10 seconds.

The Operation lamp and Timer lamp will begin to flash simultaneously during cooling test run.

Then, heating test run will begin in about 3 minutes when HEAT is selected by the remote control operation.

(When the air conditioner is running by pressing the test run button, the Operation lamp and Timer lamp will simultaneously flash slowly.)

[Release]

Perform the test operation for 60 minutes.

Pressing the MANUAL AUTO button of the indoor unit for more than 3 seconds.

[Using the Wired remote control (Option)]

If the Operation lamp is on, press the START/STOP button to turn it off.

Press the MODE and the FAN buttons at the same time for more than two seconds to start the test operation.

The operation lamp will light up and "o1" will be displayed on the set temperature display.

[Release]

Perform the test operation for 60 minutes.

Pressing the START/STOP button will stop the test operation.

12. PREVENT TO RESTART FOR 3 MINUTES (3 MINUTES ST)

The compressor won't enter operation status for 2 minutes and 20 seconds after the compressor is stopped, even if any operation is given.

13. FOUR-WAY VALVE EXTENSION SELECT

At the time when the air conditioner is switched from the cooling mode to heating mode, the compressor is stopped, and the four-way valve is switched in 2 minutes and 20 seconds later after the compressor stopped.

14. AUTO RESTART

When the power was interrupted by a power failure, etc. during operation, the operation contents at that time are memorized and when power is recovered, operation is automatically started with the memorized operation contents.

When the power is interrupted and recovered during timer operation, since the timer operation time is shifted by the time the power was interrupted, an alarm is given by blinking (7 sec ON/2 sec OFF) the indoor unit body timer lamp.

[Operation contents memorized when the power is interrupted]

- Operation mode
- Set temperature
- Set air flow
- Timer mode and set time (set by wireless remote controller)
- Set air flow Direction
- Swing
- ECONOMY operation
- MIN. HEAT operation

15. MANUAL AUTO OPERATION (Indoor unit body operation)

When the remote control is lost or battery power dissipated, this function will work without the remote control. When MANUAL AUTO button is set more than 3seconds and less than 10seconds, MANUAL AUTO OPERATION will be started as shown in Table15.To stop operation, press the MANUAL AUTO button for 3seconds.

(Table 15 : MANUAL AUTO OPERATION)

	Manual auto operation
OPERATION MODE	Auto changeover
FAN CONT. MODE	Auto
TIMER MODE	Continuous (No timer setting available)
SETTING TEMP.	75°F(24°C)
SETTING LOUVER	Standard
SWING	OFF
ECONOMY	OFF

16. FORCED COOLING OPERATION (TEST OPERATION)

When FORCED COOLING OPERATION is set, the operation is controlled as shown in Table 16.

(Table 16 : FORCED COOLING OPERATION)

	Forced cooling operation
OPERATION MODE	Cooling
FAN CONT. MODE	Hi
TIMER MODE	-
SETTING TEMP.	Room Temp is not controlled
SETTING LOUVER	Horizontal (It is changed follow as setting of remote controller)
SWING	OFF
ECONOMY	-

- Forced cooling operation is started when press MANUAL AUTO button for 10 seconds or more.
- During the forced cooling operation, it operates regardless of room temperature sensor.
- Operation LED and timer LED blink at the same time during the forced cooling operation.
They blink for 1 second ON and 1 second OFF on both operation LED and timer LED (same as test operation).
- Forced cooling operation is released after 60 minutes of starting operation or pressing MANUAL AUTO button for 3 seconds.

17. COMPRESSOR PREHEATING

When the outdoor heat exchanger temperature is lower than 41°F(5°C) and the all operation has been stopped for 30 minutes, power is applied to the compressor and the compressor is heated. (By heating the compressor, warm air is quickly discharged when operation is started.) When operation was started, and when the outdoor heat exchanger temperature rises to 44.6°F(7°C) or greater, preheating is ended.

18. MIN. (MINIMUM) HEAT OPERATION

MIN. HEAT OPERATION performs as below when pressing MIN. HEAT button or Weekly timer setting on the remote controller.

(Table 17 : MIN. HEAT OPERATION)

Mode	Heating
Setting temperature	50°F(10°C)
Fan mode	Auto
LED display	Economy
Defrost operation	Operate as normal

19. ECONOMY OPERATION

The ECONOMY operation functions by pressing ECONOMY button on the remote controller. At the maximum output, ECONOMY Operation is approximately 70% of normal air conditioner operation for cooling and heating.

The ECONOMY operation is almost the same operation as below settings.

(Table 18)

Mode	Cooling/ Dry	Heating
Target temperature	Setting temp.+2°F(+1°C)	Setting temp.-2°F(-1°C)

20. POWERFUL OPERATION

The POWERFUL OPERATION functions by pressing POWERFUL button on the remote controller. The indoor unit & outdoor unit will operate at maximum power as shown in Table 19.

(Table 19)

	Powerful operation
COMPRESSOR FREQUENCY	Maximum
FAN CONT. MODE	Powerful
SETTING LOUVER	Cooling/ Dry : 4, Heating : 5

Release Condition is as follows.

[Cooling / Dry]

- Room temperature \leq Setting temperature -3°F(- 1.5°C) or Operation time has passed 20 minutes.

[Heating]

- Room temperature \geq Setting temperature +3.5°F(+1.5°C) or Operation time has passed 20 minutes.

21. DEFROST OPERATION CONTROL

1. CONDITION OF STARTING THE DEFROST OPERATION

The defrost operation starts as shown in the following Table 20.

(Table 20 : Condition of starting Defrost Operation)

Normal defrost	Compressor integrating operation time	
	Less than 25 minutes (9/ 12RLFF) Less than 40 minutes (15RLFF)	More than 25 minutes (9/ 12RLFF) More than 40 minutes (15RLFF)
	Does not operate	
		Outdoor heat exchanger temp. $\leq 1.4^{\circ}\text{F}(-17^{\circ}\text{C})$ (at outside air temp. $\geq 14^{\circ}\text{F}(-10^{\circ}\text{C})$)
		----- Outdoor heat exchanger temp. \leq Outside air temp. $-(12.6^{\circ}\text{F} (7^{\circ}\text{C}))$ or Outdoor heat exchanger temp. $\leq -13^{\circ}\text{F} (-25^{\circ}\text{C})$ (at $-4^{\circ}\text{F} (-20^{\circ}\text{C}) \leq$ Outdoor air temp. $< 14^{\circ}\text{F} (-10^{\circ}\text{C})$)
		----- Outdoor heat exchanger temp. \leq Outside air temp. $-(12.6^{\circ}\text{F} (7^{\circ}\text{C}))$ or Outdoor heat exchanger temp. $< -22^{\circ}\text{F} (-30^{\circ}\text{C})$ (at outside air temp. $\leq -4^{\circ}\text{F}(-20^{\circ}\text{C})$)

Integrating defrost	Compressor integrating operation time		
	More than 240 minutes (For continuous operation)	More than 213 minutes (For continuous operation)	Less than 10 minutes * (For intermittent operation)
	Outdoor heat exchanger temperature below $26.6^{\circ}\text{F}(-3^{\circ}\text{C})$	Outdoor heat exchanger temperature below $23^{\circ}\text{F}(-5^{\circ}\text{C})$	OFF count of the compressor 40 times

* If the compressor continuous operation time is less than 10 minutes, the OFF number of the compressor is counted.
If any defrost operated, the compressor OFF count is cleared.

2. CONDITION OF THE DEFROST OPERATION COMPLETION

Defrost operation is released when the conditions become as shown in Table 21.

(Table 21 : Defrost Release Condition)

Release Condition
Outdoor heat exchanger temperature sensor value is higher than $60.8^{\circ}\text{F}(16^{\circ}\text{C})$ or Compressor operation time has passed 15 minutes.

3. Defrost Flow Chart

The defrosting shall proceed by the integrating operation time, outdoor temperature and outdoor heat exchanger temperature as follows.

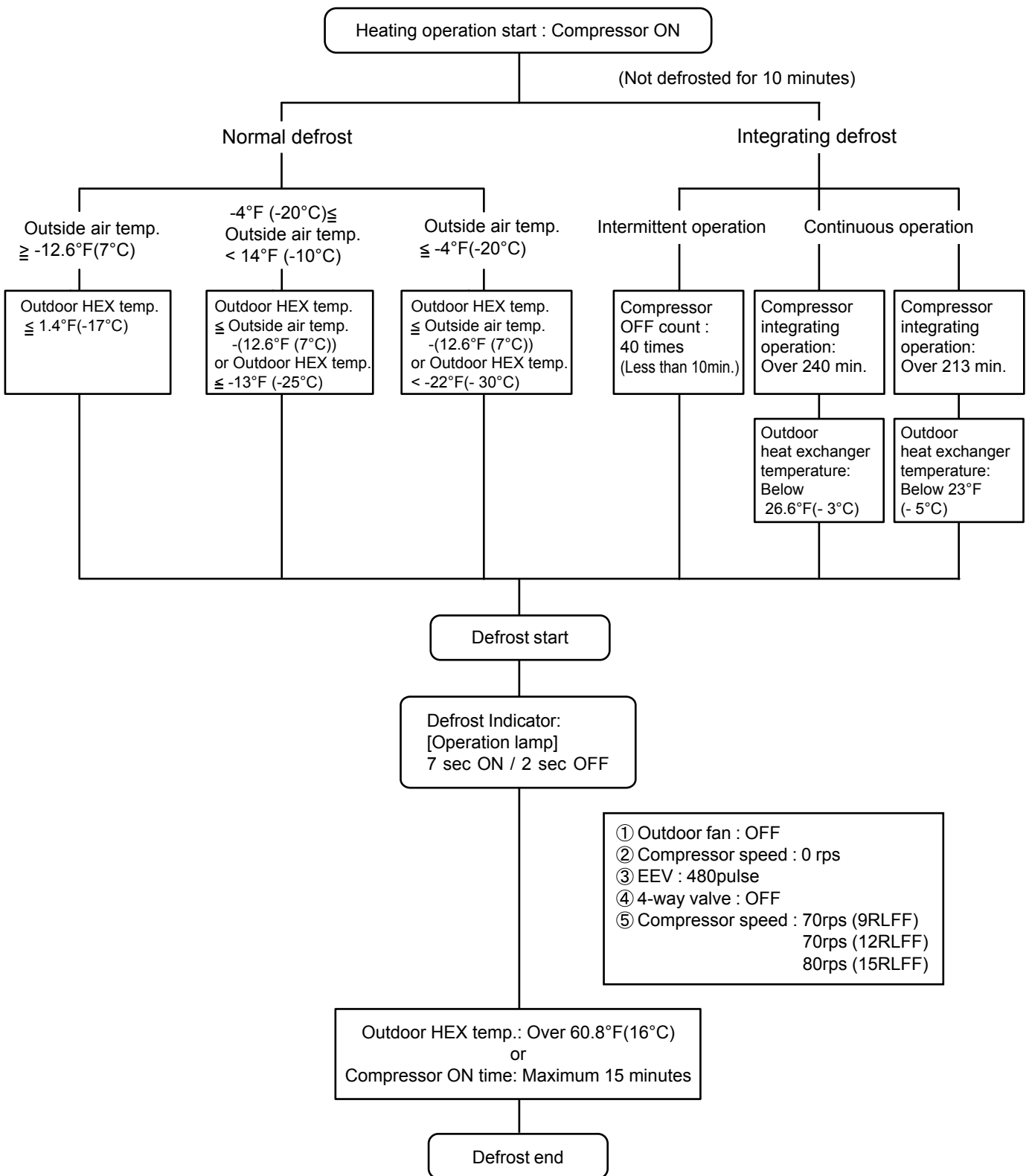

22. OFF DEFROST OPERATION CONTROL

When operation stops in the [Heating operation] mode, if frost is adhered to the outdoor unit heat exchanger, the defrost operation will proceed automatically. In this time, if indoor unit operation lamp flashes slowly (7 sec ON / 2 sec OFF), the outdoor unit will allow the heat exchanger to defrost, and then stop.

1. OFF DEFROST OPERATION CONDITION

In heating operation, the outdoor heat exchanger temperature is less than 24.8°F(- 4°C), compressor continuous operation more than 10 minutes, and compressor operation integrating time lasts for more than 30 minutes.

2. OFF DEFROST END CONDITION

Release Condition
Outdoor heat exchanger temperature sensor value is higher than 60.8°F(16°C) or Compressor operation time has passed 15 minutes.

OFF Defrost Flow Chart

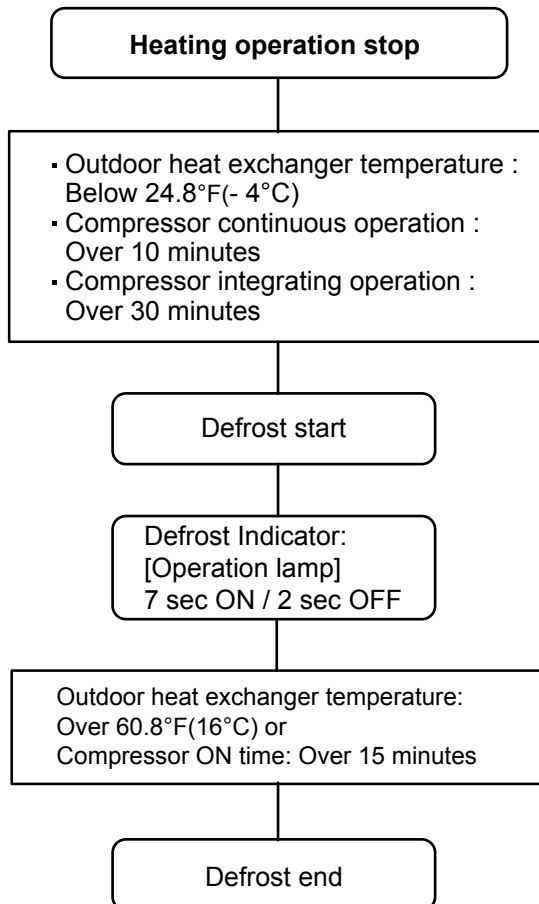

23. AIR OUTLET SELECTION (DAMPER CONTROL)

With this function , air come out simultaneously from the upper and lower air outlets so that the room can be cooled or heated effectively.

This function is set using the switch behind the front grille of the Indoor unit.

(This function is available in cooling and heating operation.)

1. How to set to blow out air from the upper and lower air outlets

Set the air outlet selection switch to 

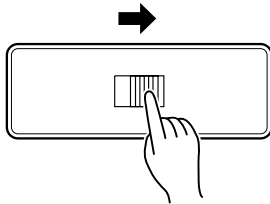

Air blows out automatically from the upper and lower air outlets as shown in Table 22 below.





NOTE:

Set the air outlet selection switch to the end.

Otherwise, air outlet cannot be selected as intended.

2. Description of operation

(Table 22 : Damper control)

Operation	COOLING Mode		DRY Mode	HEATING Mode	
Air flow	 Upper and lower air flow	 Upper air flow	 Upper air flow only	 Upper and lower air flow	 Upper air flow
Conditions	Room temperature and set temperature are different.	Room temperature is close to set temperature,* ¹ or the air conditioner has operated for 1hour.	—	Air flow temperature is high.	Air flow temperature is low.* ² (During defrosting operation, start of operation, etc.)

- Make sure the lower air outlet is not choked with foreign matters, causing abnormal operation to damper.
- When the OPERATION Indicator Lamp and the 10°C HEAT Indicator Lamp flashes, the operation can be maintained temporary by changing of air outlet selection switch to , closing the damper completely and press the START/ STOP button.
(If the damper does not close automatically, close the damper manually and fix the position by an adhesive tape etc.)
The unit operates almost the same as upper air flow operation, however the indicator lamp flashes continuously if same symptom is detected again.

(Fig.11)
In Cooling mode ※1

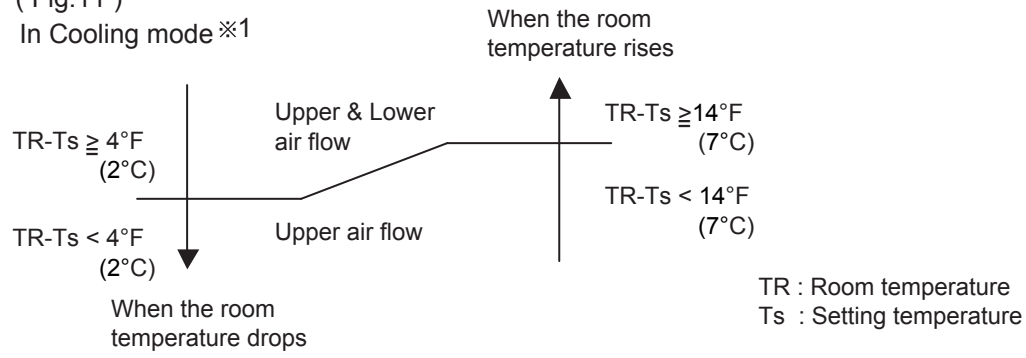

(Fig.12)
In Heating mode ※2

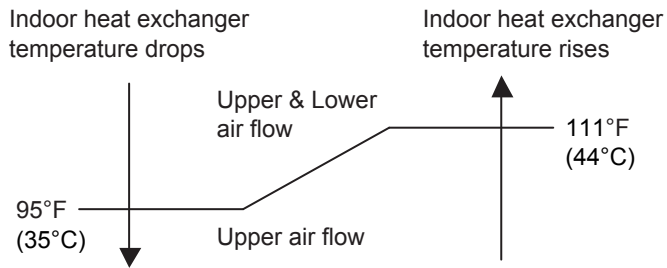

3. How to set to blow out air from the upper air outlet only

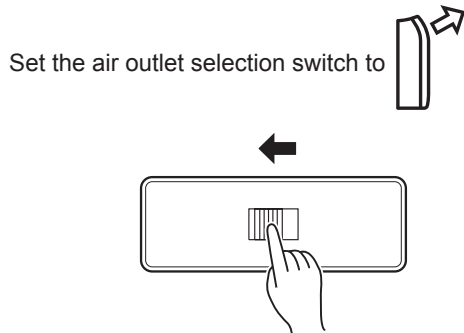

24. VARIOUS PROTECTIONS

1. DISCHARGE GAS TEMPERATURE OVERRISE PREVENION CONTROL

The discharge gas thermosensor (discharge thermistor : Outdoor side) will detect discharge gas temperature.

When the discharge temperature becomes higher than Temperature I , the compressor frequency is decreased 20rps, and it continues to decrease the frequency for 20rps every 120 seconds until the temperature becomes lower than Temperature I .

When the discharge temperature becomes lower than TemperatureII, the protection control of the compressor frequency will be released.

When the discharge temperature becomes higher than Temperature III, the compressor is stopped and the indoor unit LED starts blinking.

(Table 23 : Discharge temperature over rise prevention control / Release temperature)

Temperature I	Temperature II	Temperature III
219.2°F (104°C)	213.8°F (101°C)	230°F (110°C)

2. CURRENT RELEASE CONTROL

The compressor frequency is controlled so that the outdoor unit input current does not exceed the current limit value that was set up with the outdoor temperature.

The compressor frequency returns to the designated frequency of the indoor unit at the time when the frequency becomes lower than the release value.

(Table 24 : Current release operation value / Release value)

[Heating]

AOU9 / 12RLFF	
OT (Control / Release)	
62.6°F (17°C)	7.0A / 6.5A
53.6°F (12°C)	9.0A / 8.5A
41°F (5°C)	10.0A / 9.5A

OT : Outdoor Temperature

[Heating]

AOU15RLFF	
OT (Control / Release)	
62.6°F (17°C)	7.0A / 6.5A
53.6°F (12°C)	9.0A / 8.5A
41°F (5°C)	11.0A / 10.5A
	13.0A / 12.5A

OT : Outdoor Temperature

[Cooling]

AOU9RLFF	
OT (Control / Release)	
114.8°F (46°C)	4.5A / 4.0A
104°F (40°C)	6.0A / 5.5A
	7.0A / 6.5A

OT : Outdoor Temperature

[Cooling]

AOU12RLFF	
OT (Control / Release)	
114.8°F (46°C)	4.5A / 4.0A
104°F (40°C)	6.0A / 5.5A
	8.5A / 8.0A

OT : Outdoor Temperature

[Cooling]

AOU15RLFF	
OT (Control / Release)	
114.8°F (46°C)	4.5A / 4.0A
104°F (40°C)	6.0A / 5.5A
	9.0A / 8.5A

OT : Outdoor Temperature

3. ANTIFREEZING CONTROL (Cooling and Dry mode)

The compressor frequency is decrease on cooling & dry mode when the indoor heat exchanger temperature sensor detects the temperature lower than Temperature I. Then, the anti-freezing control is released when it becomes higher than Temperature II.

(Table 25 : Anti-freezing Protection Operation / Release Temperature)

Outdoor temperature	Temperature I	Temperature II
Over than 10°C *1 or 12°C *2	39.2°F (4°C)	44.6°F (7°C)
Less than 10°C *1 or 12°C *2		55.4°F (13°C)

*1. When the temperature drops.

*2. When the temperature rises.

4. COOLING PRESSURE OVERRISE PROTECTION

When the outdoor unit heat exchange sensor temperature rises to 152.6°F(67°C) or greater, the compressor and the outdoor fan motor are stopped and trouble display is performed.

5. HIGH TEMPERATURE RELEASE CONTROL (HEATING MODE)

On heating mode, the compressor frequency is controlled as following based on the detection value of the indoor heat exchanger temperature sensor.

[Control System]

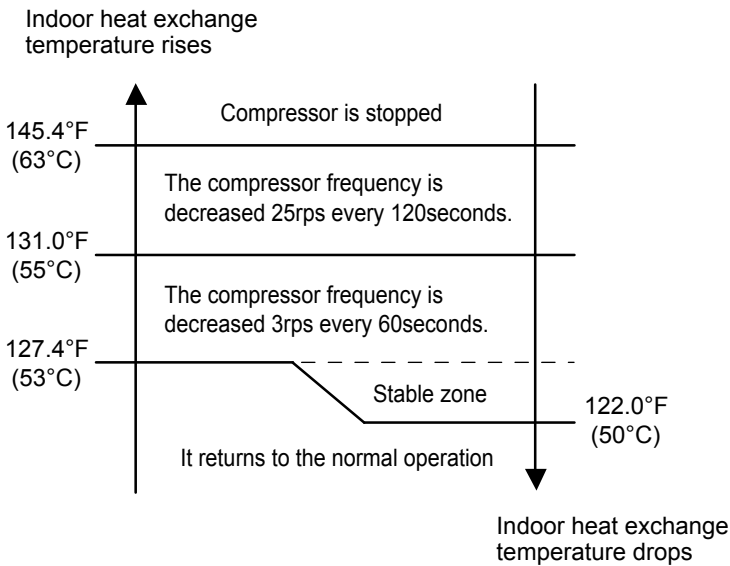

FLOOR type INVERTER

2 . TROUBLE SHOOTING

2. TROUBLESHOOTING

2-1 ERROR DISPLAY

2-1-1 INDOOR UNIT AND WIRED REMOTE CONTROLLER DISPLAY

Please refer the flashing pattern as follows.

The OPERATION, TIMER and ECONOMY lamps operate as follows according to the error contents.

Error Contents	Indoor Unit Display			Wired Remote Controller Display	Trouble shooting
	OPERATION (Green)	TIMER (Orange)	ECONOMY (Green)		
Serial communication error	1 times	1 times	Continuous	11	1 - 1,1 - 2
Wired remote controller communication error	1 times	2 times	Continuous	12	2
Indoor unit model information error EEPROM access abnormal	3 times	2 times	Continuous	32	3
Manual auto switch error	3 times	5 times	Continuous	35	4
Indoor room thermistor error	4 times	1 times	Continuous	41	5
Indoor heat Ex.(Pipe) thermistor error	4 times	2 times	Continuous	42	6
Indoor unit fan motor error	5 times	1 times	Continuous	51	7
Damper error	5 times	7 times	Continuous	57	8 - 1,8 - 2
Outdoor unit main PCB error	6 times	2 times	Continuous	62	9
PFC circuit error (9 / 12RLFF) Active filter error (15RLFF)	6 times	4 times	Continuous	64	10 - 1,10 - 2
IPM error	6 times	5 times	Continuous	65	11
Discharge thermistor error	7 times	1 times	Continuous	71	12
Heat Ex. (Pipe) thermistor error	7 times	3 times	Continuous	73	13
Outdoor thermistor error	7 times	4 times	Continuous	74	14
Current sensor error	8 times	4 times	Continuous	84	15
Over current error	9 times	4 times	Continuous	94	16
Compressor control error	9 times	5 times	Continuous	95	17
Outdoor unit fan motor error	9 times	7 times	Continuous	97	18
4 Way valve error	9 times	9 times	Continuous	99	19
Discharge temp. error	10 times	1 times	Continuous	A1	20

2-1-2 WIRED REMOTE CONTROLLER DISPLAY (OPTION)

1. SELF - DIAGNOSIS

When "Er" in Temperature Display is displayed, inspection of the air conditioning system is necessary. Please consult authorized service personnel.

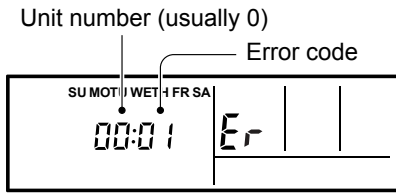

ex. Self-diagnosis check

2. ERROR CODE HISTORY DISPLAY

Up to 16 memorized error codes may be displayed for the indoor unit connected to the remote controller.

1. Stop the air conditioner operation.

2. Press the SET TEMPERATURE buttons ∇ , \blacktriangle simultaneously for 3 seconds or more to start the self-diagnosis.

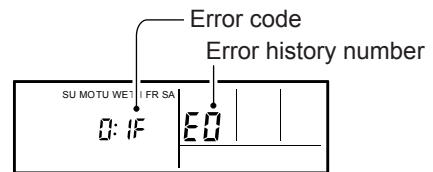
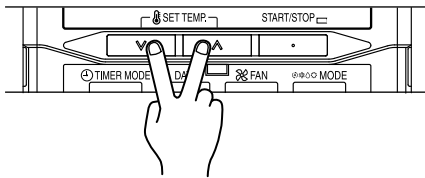

3. Press the SET TEMPERATURE button to select the error history number.

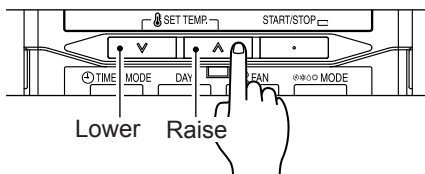

0 ↔ 1 ↔ 2 ↔ 3 ↔ 4 ↔ 5 ↔ 6 ↔ 7
F ↔ E ↔ d ↔ c ↔ b ↔ A ↔ 9 ↔ 8

4. Press the SET TEMPERATURE buttons ∇ , \blacktriangle simultaneously for 3 seconds or more or there is no key input for 60 seconds to stop the display.

2-2 TROUBLE SHOOTING WITH ERROR CODE

Trouble shooting 1-1
OUTDOOR UNIT Error Method:
Serial communication error
(Serial Reverse Transfer Error)

Indicate or Display:

Refer to error code table.

Detective Actuators:

Outdoor unit Main PCB
 Outdoor unit fan motor

Detective details:

When the indoor unit cannot receive the serial signal from Outdoor unit more than 2minutes after power ON, or the indoor unit cannot receive the serial signal more than 15seconds during normal operation.

Forecast of Cause:

1. Connection failure 2. External cause 3. Main PCB failure 4. Outdoor unit fan motor failure

Check Point 1-1 : Reset the power and operate

· Does Error indication show again?

NO

YES

Check Point 2 : Check Connection

· Check any loose or removed connection line of Indoor unit and Outdoor unit.
 >> **If there is an abnormal condition, correct it by referring to Installation Manual or Data & Technical Manual.**

Check Point 1-2: Check external cause such as noise

· Check the complete insulation of the grounding.
 · Check if there is any equipment that causes harmonic wave near the power cable (Neon light bulb or any electronic equipment which causes harmonic wave).

OK

Check Point 3 : Check the voltage of power supply

· Check the voltage of power supply
 >> **Check if AC187V (AC208V -10%) - 253V (AC230V +10%) appears at Outdoor Unit Terminal L - N.**

AC

OK

Check Point 4 : Check Serial Signal (Reverse Transfer Signal)

· Check Serial Signal (Reverse Transfer Signal)
 >> **Check if Indicated value swings between AC90V and AC270V at Outdoor Unit Terminal 1 - 3.**
 >> **If it is abnormal, Check Outdoor unit fan motor. (PARTS INFORMATION 5)**
 >> **If Outdoor fan motor is abnormal, replace Outdoor unit fan motor and Main PCB.**
 >> **If Outdoor fan motor is normal, replace Main PCB.**

AC

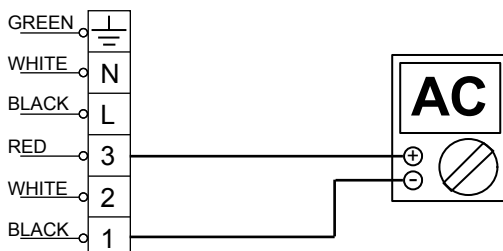

<p>Trouble shooting 1-2 INDOOR UNIT Error Method: Serial communication error (Serial Forward Transfer Error)</p>	<p>Indicate or Display: Refer to error code table.</p>
---	---

<p>Detective Actuators: Indoor unit Controller PCB Indoor unit Fan motor</p>	<p>Detective details: When the outdoor unit cannot receive the serial signal from Indoor unit more than 10seconds.</p>
---	--

Forecast of Cause:
1. Connection failure 2. External cause 3. Controller PCB failure 4. Indoor unit fan motor failure

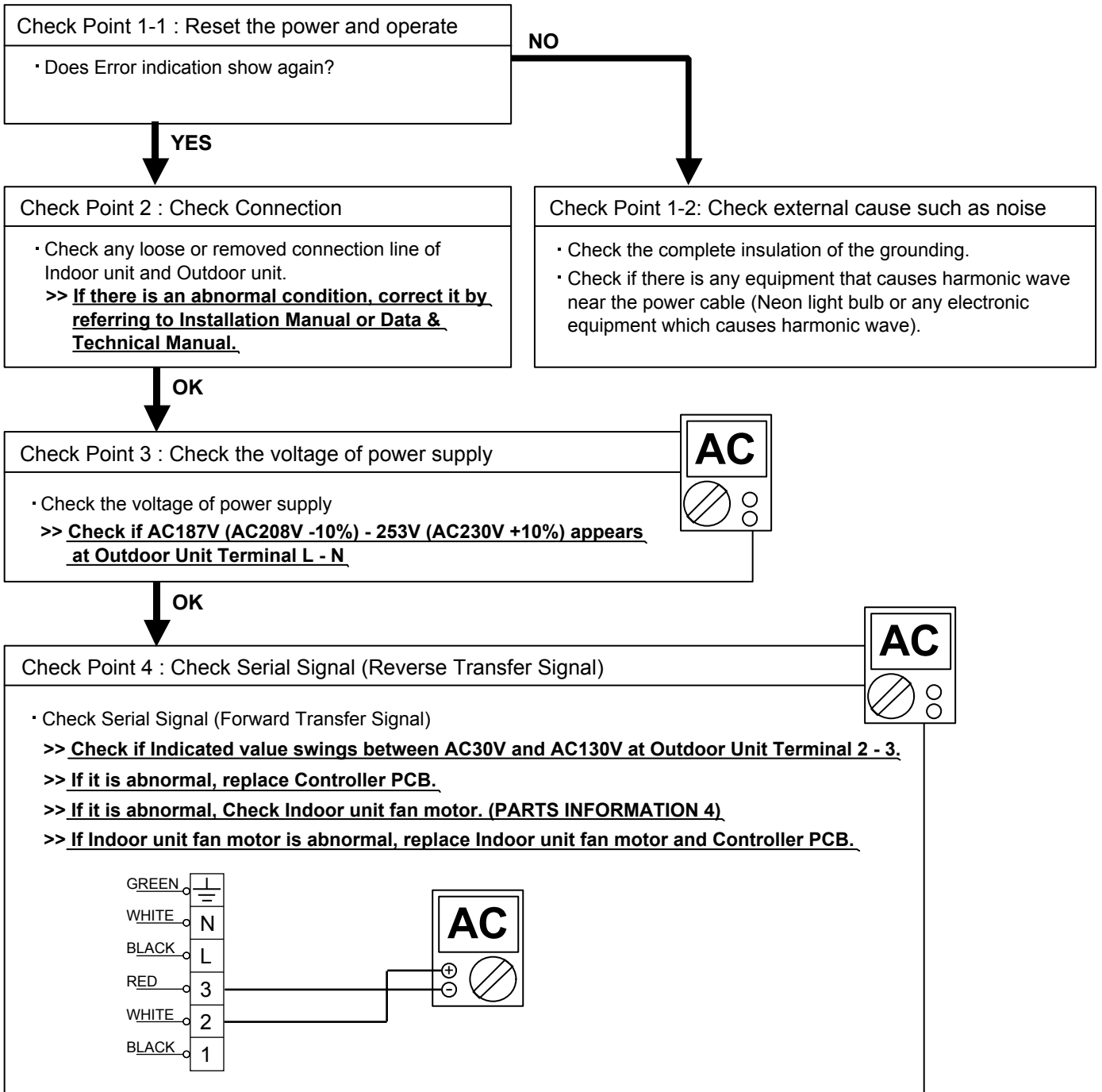

Trouble shooting 2 <u>INDOOR UNIT Error Method:</u> Wired remote controller communication error	<u>Indicate or Display:</u> Refer to error code table.
--	---

<u>Detective Actuators:</u> Indoor unit Controller PCB Wired remote control	<u>Detective details:</u> When the indoor unit cannot receive the signal from Wired Remote Control more than 1minute during normal operation.
--	---

<u>Forecast of Cause:</u> 1. Terminal connection abnormal 2. Wired remote control failure 3. Controller PCB failure

Check Point 1 : Check the connection of terminal
<u>After turning off the power, check & correct the followings.</u> · Check the connection of terminal between remote control and Indoor unit, and check if there is a disconnection of the cable.



Check Point 2 : Check Remote Control and Controller PCB	
<ul style="list-style-type: none"> · Check Voltage at CN6 (terminal 1-3) of Controller PCB. (Power supply to Remote Control) >> If it is DC13V, Remote Control is failure. (Controller PCB is normal) >> Replace Remote Control >> If it is DC 0V, Controller PCB is failure. (Check Remote Control once again) >> Replace Controller PCB <p>▶ <u>Upon correcting the removed connector or mis-wiring, reset the power.</u></p>	

Trouble shooting 3 <u>INDOOR UNIT Error Method:</u> Indoor unit model information error EEPROM access abnormal	<u>Indicate or Display:</u> Refer to error code table.
---	---

<u>Detective Actuators:</u> Indoor unit Controller PCB	<u>Detective details:</u> When power is on and there is some below case. 1. When model information of EEPROM is incorrect. 2. When the access to EEPROM failed.
--	---

<u>Forecast of Cause:</u> 1. External cause 2. Defective connection of electric components 3. Controller PCB failure
--

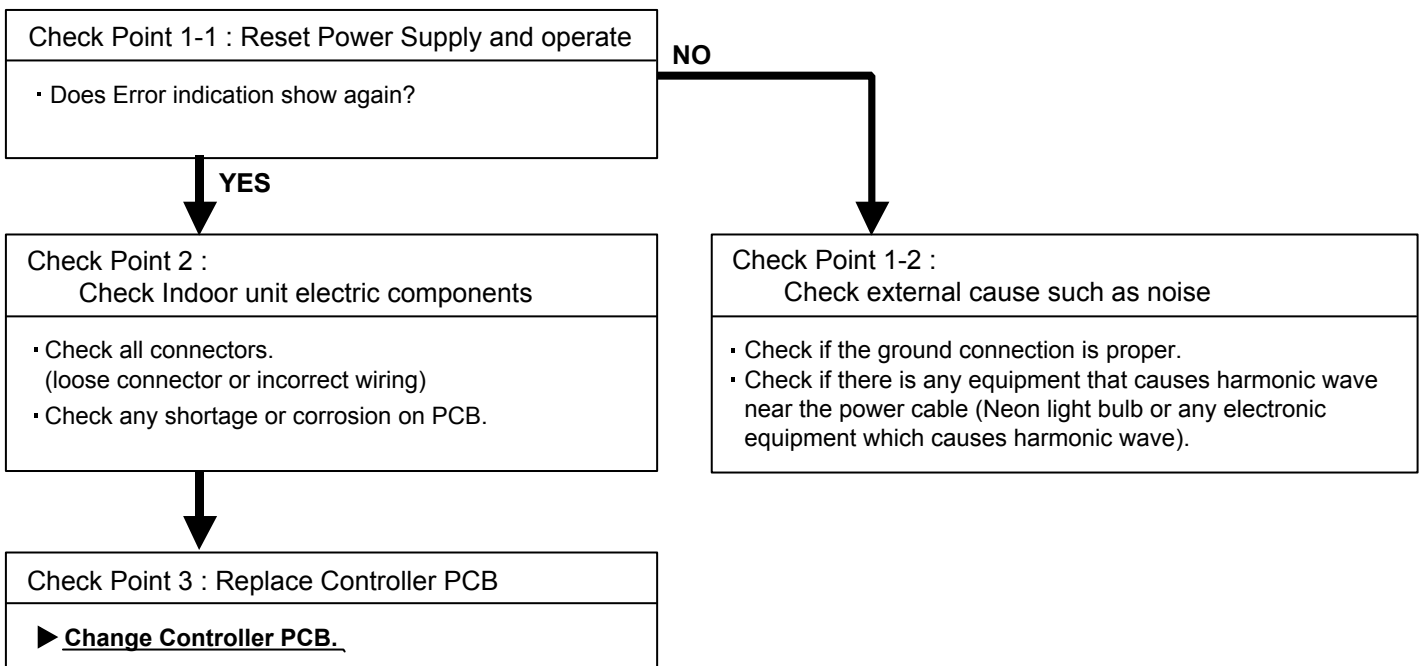

Note : EEPROM

EEPROM(Electronically Erasable and Programmable Read Only Memory) is a non-volatile memory which keeps memorized information even if power is turned off. It can change the contents electronically. To change the contents, it uses higher voltage than normal, and it can not change a partial contents. (Rewriting shall be done upon erasing the all contents.) There is a limit in a number of rewriting.

<p>Trouble shooting 4 <u>INDOOR UNIT Error Method:</u> Manual auto switch error</p>	<p><u>Indicate or Display:</u></p> <p>Refer to error code table.</p>
--	--

<p><u>Detective Actuators:</u></p> <p>Indoor unit Controller PCB Indicator PCB Manual auto switch</p>	<p><u>Detective details:</u></p> <p>When the Manual Auto Switch becomes ON for consecutive 60 or more seconds.</p>
--	---

<p><u>Forecast of Cause :</u></p> <p>1. Manual auto switch failure 2. Controller PCB and Indicator PCB failure</p>
--

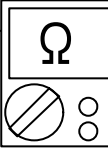
<p>Check Point 1 : Check the Manual auto switch</p> <ul style="list-style-type: none"> • Check if Manual auto switch is kept pressed. • Check ON/OFF switching operation by using a meter. <p>>><u>If Manual Auto Switch is disabled (on/off switching), replace it.</u></p>	
---	--



<p>Check Point 2 : Replace Controller PCB</p>
<p>▶ <u>If Check Point 1 do not improve the symptom, change Controller PCB and Indicator PCB.</u></p>

Trouble shooting 5 INDOOR UNIT Error Method: Indoor room thermistor error	Indicate or Display: Refer to error code table.
--	--

Detective Actuators: Indoor unit Controller PCB Room temperature thermistor	Detective details: When Room Temperature Thermistor open or short-circuit is detected.
--	--

Forecast of Cause : 1. Connector connection failure 2. Thermistor failure 3. Controller PCB failure

Check Point 1 : Check connection of Connector
<ul style="list-style-type: none"> • Check if connector is removed. • Check erroneous connection. • Check if thermistor cable is open. <p>>>Upon correcting the removed connector or mis-wiring, reset the power.</p>



Check Point 2 : Check the voltage value between the terminals at Thermistor	DC 								
<ul style="list-style-type: none"> • Check Voltage at CN1 (terminal 1-2) of Controller PCB. 									
Thermistor Characteristics (Approx. value)									
Temperature	14°F	23°F	32°F	41°F	50°F	59°F	68°F	77°F	86°F
Voltage value (V)	4.27	4.07	3.85	3.61	3.34	3.06	2.78	2.50	2.23
Temperature	95°F	104°F	113°F						
Voltage value (V)	1.97	1.73	1.52						
► If the voltage does not appear, replace Controller PCB.									

Trouble shooting 6 INDOOR UNIT Error Method: Indoor heat Ex.(Pipe) thermistor error	Indicate or Display: Refer to error code table.
--	--

Detective Actuators: Indoor unit Controller PCB Heat Ex. temperature thermistor	Detective details: When Heat Ex. Temperature Thermistor open or short-circuit is detected.
--	--

Forecast of Cause :
 1. Connector connection failure 2. Thermistor failure 3. Controller PCB failure

Check Point 1 : Check connection of Connector

- Check if connector is removed.
- Check erroneous connection.
- Check if thermistor cable is open.

>>Upon correcting the removed connector or mis-wiring, reset the power.



Check Point 2 : Remove connector and check Thermistor resistance value

Thermistor Characteristics (Approx. value)

Temperature (°F)	14°F	23°F	32°F	41°F	50°F	68°F
Resistance Value (kΩ)	312.3	233.2	176.0	134.2	103.3	62.9

Temperature (°F)	86°F	104°F	122°F	140°F	144°F
Resistance Value (kΩ)	39.6	25.6	17.1	11.6	10.4

► If Thermistor is either open or shorted, replace it and reset the power.



Check Point 3 : Check voltage of Controller PCB (DC5.0V)

Make sure circuit diagram of indoor unit and check terminal voltage at Thermistor (DC5.0V)

THERMISTOR (PIPE)

THERMISTOR (ROOM TEMP.)

► If the voltage does not appear, replace Controller PCB.

Trouble shooting 7 <u>INDOOR UNIT Error Method:</u> Indoor unit fan motor error	<u>Indicate or Display:</u> Refer to error code table.
--	---

<u>Detective Actuators:</u> Indoor unit Controller PCB Indoor unit Fan motor	<u>Detective details:</u> When the condition that actual frequency of Indoor Fan is below 1/3 of target frequency is continued more than 56 seconds.
---	--

<u>Forecast of Cause:</u> 1. Fan rotation failure 2. Fan motor winding open 3. Motor protection by surrounding temperature rise 4. Control PCB failure 5. Indoor unit fan motor failure
--

Check Point 1 : Check rotation of Fan
<ul style="list-style-type: none"> · Rotate the fan by hand when operation is off. (Check if fan is caught, dropped off or locked motor) >><u>If Fan or Bearing is abnormal, replace it.</u>

↓ **OK**

Check Point 2 : Check ambient temp. around motor
<ul style="list-style-type: none"> · Check excessively high temperature around the motor. (If there is any surrounding equipment that causes heat) >><u>Upon the temperature coming down, restart operation.</u>

↓ **OK**

Check Point 3 : Check Indoor unit fan motor
<ul style="list-style-type: none"> · Check Indoor unit fan motor. (PARTS INFORMATION 4) >><u>If Indoor unit fan motor is abnormal, replace Indoor unit fan motor.</u>

↓ **OK**

Check Point 4 : Replace Controller PCB
<ul style="list-style-type: none"> ▶ <u>If Check Point 1- 3 do not improve the symptom, replace Controller PCB.</u>

Trouble shooting 8-1 INDOOR UNIT Error Method: Damper error (Damper(Open/Close) detection Limit switch error)	Indicate or Display: Refer to error code table.
---	--

Detective Actuators: Indoor unit Controller PCB Limit switch Damper	Detective details: When limit switch were not able to detect the close though the damper close. (Upper air flow) When limit switch were not able to detect the open though the damper open. (Upper & Lower air flow)
---	---

Forecast of Cause : 1. Limit switch failure 2. Shorted connector/ wire 3. Damper faulure 4. Controller PCB failure

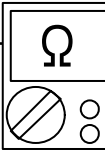
Check Point 1 : Check Limit switch <ul style="list-style-type: none"> • Check operation of limit switch. (any blocking by dust, etc.) • Remove Limit switch and check ON/OFF switching operation by using a meter. >>If Limit switch is detective, replace it.	
---	---



Check Point 2 : Check Connector (CN18) / Wire <ul style="list-style-type: none"> • Check loose contact of CN18 /shorted wire (pinched wire). >>Replace Limit switch if the wire is abnormal



Check Point 3 : Check Damper <ul style="list-style-type: none"> • Check the obstruction of damper movement. • Check the damper movement. >>Replace Damper if the damper is abnormal
--



Check Point 4 : Replace Controller PCB ▶ If Check Point 1~3 do not improve the symptom, change Controller PCB.

Trouble shooting 8-2 INDOOR UNIT Error Method: Damper error (Damper(Open/Close) simultaneous detection Limit switch error)	<u>Indicate or Display:</u> Refer to error code table.
---	--

<u>Detective Actuators:</u> Indoor unit Controller PCB Limit switch	<u>Detective details:</u> When the limit switch detects open and close at the simultaneous.
---	--

<u>Forecast of Cause :</u> 1. Limit switch failure 2. Shorted connector/ wire 3. Controller PCB failure
--

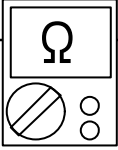
Check Point 1 : Check Limit switch <ul style="list-style-type: none"> • Check operation of limit switch. (any blocking by dust, etc.) • Remove Limit switch and check ON/OFF switching operation by using a meter. >>If Limit switch is detective, replace it.	
---	---

↓
OK

Check Point 2 : Check Connector (CN18) / Wire <ul style="list-style-type: none"> • Check loose contact of CN18 /shorted wire (pinched wire). >>Replace Limit switch if the wire is abnormal

↓
OK

Check Point 3 : Replace Controller PCB ▶ <u>If Check Point 1 & 2 do not improve the symptom, change Controller PCB.</u>
--

<p>Trouble shooting 9 <u>OUTDOOR UNIT Error Method:</u> Outdoor unit main PCB error</p>	<p><u>Indicate or Display:</u> Refer to error code table.</p>
--	--

<p><u>Detective Actuators:</u> Outdoor unit Main PCB</p>	<p><u>Detective details:</u> Access to EEPROM failed due to some cause after outdoor unit started.</p>
--	--

<p><u>Forecast of Cause:</u> 1. External cause (Noise, temporary open, voltage drop) 2. Main PCB failure</p>
--

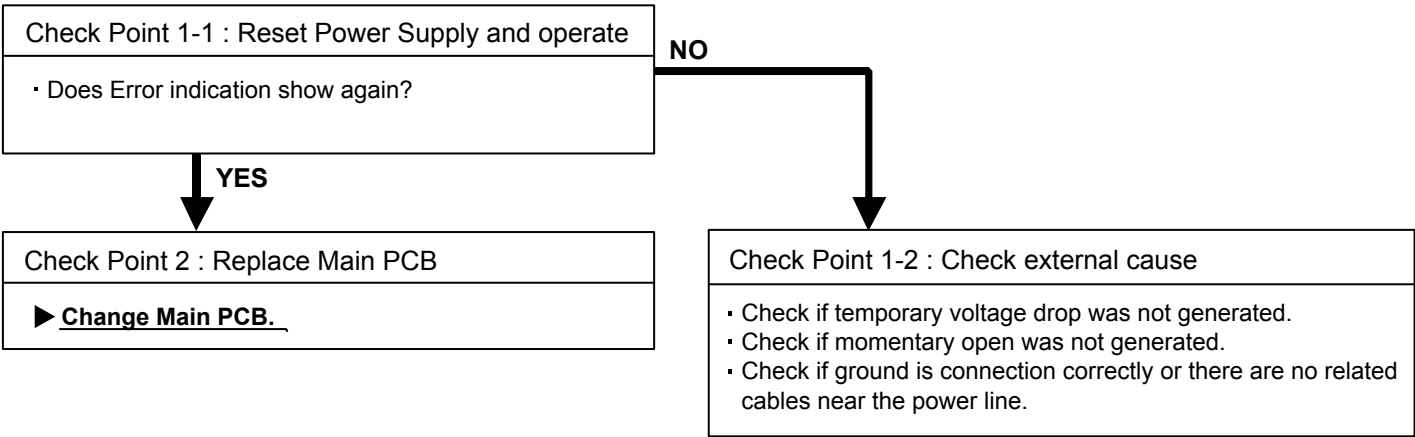

For AOU9 / 12RLFF

Trouble shooting 10-1 <u>OUTDOOR UNIT Error Method:</u> PFC circuit error	<u>Indicate or Display:</u> Refer to error code table.
--	---

<u>Detective Actuators:</u> Outdoor unit Main PCB	<u>Detective details:</u> When inverter output DC voltage is higher than 415V for over 3 seconds, the compressor stops. If the same operation is repeated 5 times, the compressor stops permanently.
---	---

<u>Forecast of Cause :</u> 1. External cause 2. Connector connection failure 3. Main PCB failure
--

Check Point 1 : Check external cause at Indoor and Outdoor (Voltage drop or Noise)
<ul style="list-style-type: none">• Instant drop : Check if there is a large load electric apparatus in the same circuit.• Momentary power failure : Check if there is a defective contact or leak current in the power supply circuit.• Noise : Check if there is any equipment causing harmonic wave near electric line. (Neon bulb or electric equipment that may cause harmonic wave) Check the complete insulation of grounding.



Check Point 2 : Check connection of Connector
<ul style="list-style-type: none">• Check if connector is removed.• Check erroneous connection.• Check if cable is open. <p>>><u>Upon correcting the removed connector or mis-wiring, reset the power.</u></p>



Check Point 3 : Replace Main PCB
<p>▶ <u>If Check Point 1, 2 do not improve the symptom, change Main PCB.</u></p>

For AOU15RLFF

<p>Trouble shooting 10-2 <u>OUTDOOR UNIT Error Method:</u> Active filter error</p>	<p><u>Indicate or Display:</u> Refer to error code table.</p>
---	--

<p><u>Detective Actuators:</u> Outdoor unit Main PCB Active filter module</p>	<p><u>Detective details:</u> When inverter input DC voltage is higher than 425V or lower than 80V. When a momentary power cut off occurred on low voltage</p>
--	--

<p><u>Forecast of Cause :</u> 1. External cause 2. Connector connection failure 3. Main PCB failure 4. Active filter module failure</p>
--

<p>Check Point 1 : Check external cause at Indoor and Outdoor (Voltage drop or Noise)</p> <ul style="list-style-type: none"> • Instant drop : Check if there is a large load electric apparatus in the same circuit. • Momentary power failure : Check if there is a defective contact or leak current in the power supply circuit. • Noise : Check if there is any equipment causing harmonic wave near electric line. (Neon bulb or electric equipment that may cause harmonic wave) Check the complete insulation of grounding.



<p>Check Point 2 : Check connection of Connector</p> <ul style="list-style-type: none"> • Check if connector is removed. • Check erroneous connection. • Check if cable is open. <p>>><u>Upon correcting the removed connector or mis-wiring, reset the power.</u></p>



<p>Check Point 3 : Check Active filter module</p> <ul style="list-style-type: none"> • Check Active filter module. (PARTS INFORMATION 6) >><u>If Active filter module is abnormal, replace it.</u>



<p>Check Point 4 : Replace Main PCB</p> <p>▶ <u>If Check Point 1 - 3 do not improve the symptom, change Main PCB.</u></p>

Trouble shooting 11 OUTDOOR UNIT Error Method: IPM error	Indicate or Display: Refer to error code table.
---	--

Detective Actuators: Outdoor unit Main PCB Outdoor unit Transistor PCB (15L) Compressor	Detective details: ① When more than normal operating current to IPM in Main PCB flows, the compressor stops. ② After the compressor restarts, if the same operation is repeated within 40sec, the compressor stops again. ③ If ① and ② repeats 5 times, the compressor stops permanently.
---	---

Forecast of Cause : 1. Defective connection of electric components 2. Outdoor Fan Operation failure 3. Outdoor Heat Exchanger clogged 4. Compressor failure 5. Main PCB failure 6. Transistor PCB failure (For AOU15RLFF)
--

Check Point 1 : Check connections of Outdoor Unit Electrical Components
<ul style="list-style-type: none"> • Check if the terminal connection is loose. • Check if connector is removed. • Check erroneous connection. • Check if cable is open. <p>>> Upon correcting the removed connector or mis-wiring, reset the power.</p>



Check Point 2 : Check Outdoor Fan, Heat Exchanger
<ul style="list-style-type: none"> • Is there anything obstructing the air distribution circuit? • Is there any clogging of Outdoor Heat Exchanger? • Is the Fan rotating by hand when operation is off ? <p>>> If the Fan Motor is locked, replace it.</p>



Check Point 3 : Check Outdoor Fan
<ul style="list-style-type: none"> • Check Outdoor Fan Motor. (Refer to Trouble shooting 18) <p>>> If the Fan Motor is failure, replace it.</p>



Check Point 4 : Check Compressor
<ul style="list-style-type: none"> • Check Compressor. (PARTS INFORMATION 2)



Check Point 5 : Check Transistor PCB (For AOU15RLFF)
<ul style="list-style-type: none"> • Check Transistor PCB. (PARTS INFORMATION 7)



Check Point 6 : Replace Main PCB
▶ If Check Point 1 ~ 5 do not improve the symptom, change Main PCB.

Trouble shooting 12 OUTDOOR UNIT Error Method: Discharge thermistor error	Indicate or Display: Refer to error code table.
--	--

Detective Actuators: Outdoor unit Main PCB Discharge pipe temperature thermistor	Detective details: When Discharge pipe temperature thermistor open or short-circuit is detected at power ON or while running the compressor.
---	--

Forecast of Cause :
1. Connector connection failure 2. Thermistor failure 3. Main PCB failure

Check Point 1 : Check connection of Connector

- Check if connector is removed.
- Check erroneous connection.
- Check if thermistor cable is open.

>>Upon correcting the removed connector or mis-wiring, reset the power.



Check Point 2 : Remove connector and check Thermistor resistance value

Ω

Thermistor Characteristics (Approx. value)

Temperature (°F)	14°F	23°F	32°F	41°F	50°F	68°F	86°F	104°F	122°F
Resistance Value (k Ω)	292.9	221.1	168.6	129.8	100.9	62.5	40.0	26.3	17.8

Temperature (°F)	140°F	158°F	176°F	194°F	212°F	230°F	248°F
Resistance Value (k Ω)	12.3	8.7	6.3	4.6	3.4	2.6	2.0

► If Thermistor is either open or shorted, replace it and reset the power.



Check Point 3 : Check voltage of Main PCB (DC5.0V)

DC

Make sure circuit diagram of outdoor unit and check terminal voltage at Thermistor (DC5.0V)

AOU9 / 12RLFF

THERMISTOR (PIPE)	BLACK	1	1	CN71
	BLACK	2	2	
	BROWN	3	3	
	BROWN	4	4	
THERMISTOR (DISCHARGE)				
THERMISTOR (OUTDOOR)				
	BLACK	1	1	CN70
	BLACK	2	2	
	BLACK	3	3	

AOU15RLFF

THERMISTOR (PIPE)	BLACK	1	1	CN61
	BLACK	2	2	
	BROWN or BLACK	3	3	
	BROWN or BLACK	4	4	
THERMISTOR (DISCHARGE)				
THERMISTOR (OUTDOOR)				
	BLACK	1	1	CN62
	BLACK	2	2	
	BLACK	3	3	

► If the voltage does not appear, replace Main PCB.

02-17

Trouble shooting 13 OUTDOOR UNIT Error Method: Heat Ex.(Pipe) thermistor error	Indicate or Display: Refer to error code table.
---	--

Detective Actuators: Outdoor unit Main PCB Heat exchanger thermistor	Detective details: When Heat exchanger temperature thermistor open or short-circuit is detected at power ON or while running the compressor.
---	--

Forecast of Cause :
1. Connector connection failure 2. Thermistor failure 3. Main PCB failure

Check Point 1 : Check connection of Connector

- Check if connector is removed.
- Check erroneous connection.
- Check if thermistor cable is open.

>>Upon correcting the removed connector or mis-wiring, reset the power.



Check Point 2 : Remove connector and check Thermistor resistance value

Thermistor Characteristics (Approx. value)

Temperature (°F)	14°F	23°F	32°F	41°F	50°F	68°F	86°F	104°F	122°F
Resistance Value (kΩ)	27.8	21.0	16.1	12.4	9.6	6.0	3.8	2.5	1.7

Temperature (°F)	140°F	158°F	176°F
Resistance Value (kΩ)	1.2	0.8	0.6

► If Thermistor is either open or shorted, replace it and reset the power.



Check Point 3 : Check voltage of Main PCB (DC5.0V)

Make sure circuit diagram of outdoor unit and check terminal voltage at Thermistor (DC5.0V)

AOU9/ 12RLFF

THERMISTOR (PIPE)	BLACK	1	1	CN71
	BLACK	2	2	
THERMISTOR (DISCHARGE)	BROWN	3	3	
	BROWN	4	4	
THERMISTOR (OUTDOOR)	BLACK	1	1	CN70
	BLACK	2	2	
	BLACK	3	3	

AOU15RLFF

THERMISTOR (PIPE)	BLACK	1	1	CN61
	BLACK	2	2	
THERMISTOR (DISCHARGE)	BROWN or BLACK	3	3	
	BROWN or BLACK	4	4	
THERMISTOR (OUTDOOR)	BLACK	1	1	CN62
	BLACK	2	2	
	BLACK	3	3	

► If the voltage does not appear, replace Main PCB.

02-18

Trouble shooting 14 OUTDOOR UNIT Error Method: Outdoor thermistor error	Indicate or Display: Refer to error code table.
--	--

Detective Actuators: Outdoor unit Main PCB Outdoor thermistor	Detective details: When Outdoor temperature thermistor open or short-circuit is detected at power ON or while running the compressor.
--	---

Forecast of Cause :
1. Connector connection failure 2. Thermistor failure 3. Main PCB failure

Check Point 1 : Check connection of Connector

- Check if connector is removed.
- Check erroneous connection.
- Check if thermistor cable is open.

>>Upon correcting the removed connector or mis-wiring, reset the power.



Check Point 2 : Remove connector and check Thermistor resistance value

Ω

Thermistor Characteristics (Approx. value)

Temperature (°F)	-4°F	5°F	14°F	23°F	32°F	41°F	50°F	68°F	86°F
Resistance Value (k Ω)	115.2	84.2	62.3	46.6	35.2	26.9	20.7	12.6	8.0

Temperature (°F)	95°F	104°F	113°F	122°F	131°F
Resistance Value (k Ω)	6.4	5.2	4.2	3.5	2.8

► If Thermistor is either open or shorted, replace it and reset the power.



Check Point 3 : Check voltage of Main PCB (DC5.0V)

DC

Make sure circuit diagram of outdoor unit and check terminal voltage at Thermistor (DC5.0V)

AOU9/ 12RLFF

AOU15RLFF

► If the voltage does not appear, replace Main PCB.

Trouble shooting 15 OUTDOOR UNIT Error Method: Current sensor error	Indicate or Display: Refer to error code table.
--	--

Detective Actuators: Outdoor unit Main PCB	Detective details: When Input Current Sensor has detected 0A, while Inverter Compressor is operating at higher than 56rps, after 1minute upon starting the Compressor. (Except during the defrost operation)
--	--

Forecast of Cause : 1. Defective connection of electric components 2. External cause 3. Main PCB failure
--

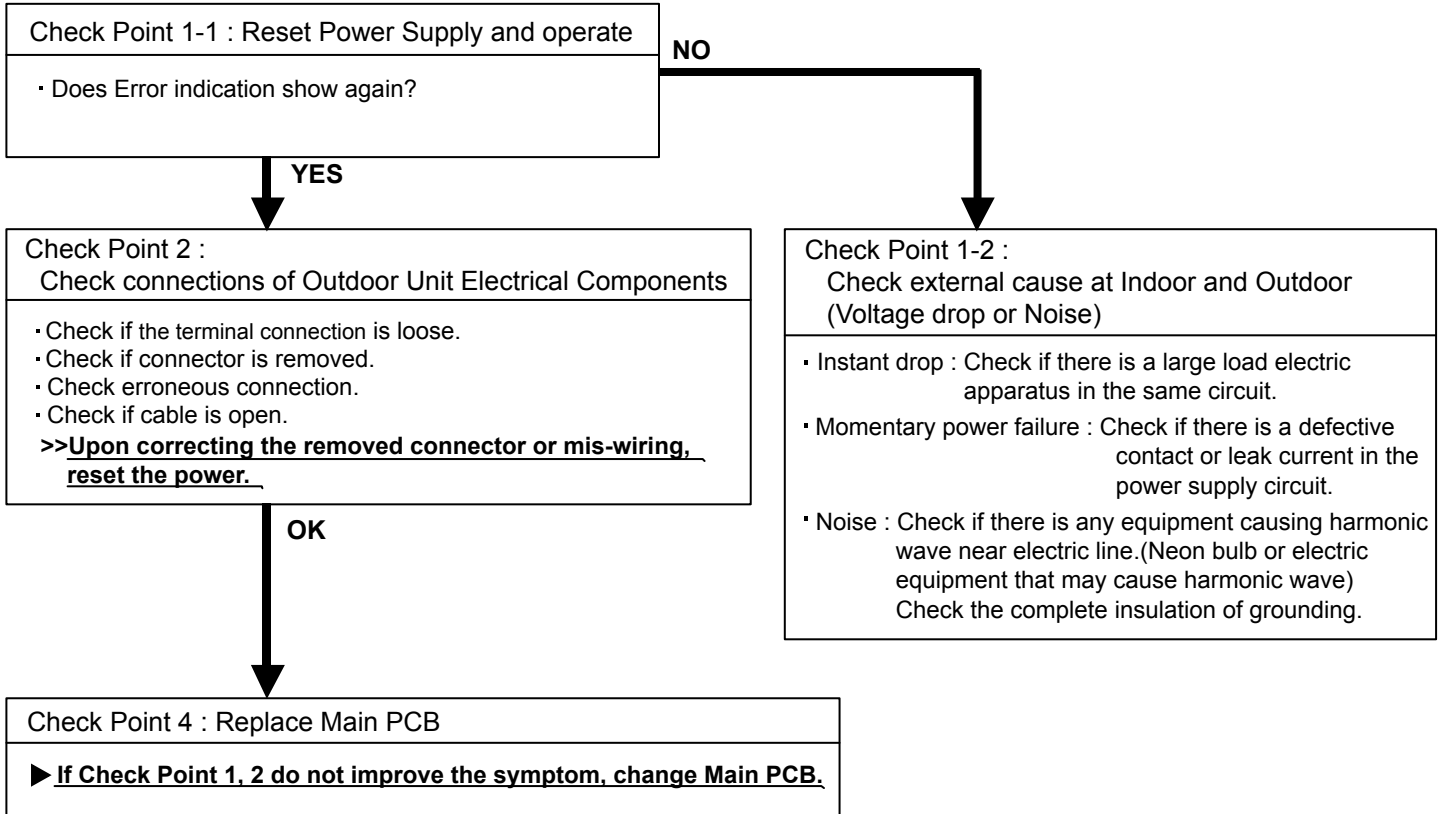

Trouble shooting 16 <u>OUTDOOR UNIT Error Method:</u> Trip detection	<u>Indicate or Display:</u> Refer to error code table.
---	---

<u>Detective Actuators:</u> Outdoor unit Main PCB Compressor	<u>Detective details:</u> • "Protection stop by overcurrent generation after inverter compressor start processing completed" generated consecutively 10 times. * The number of generations is reset if the start-up of the compressor succeeds.
---	---

<u>Forecast of Cause :</u> <ol style="list-style-type: none"> 1. Outdoor unit fan operation defective, foreign matter on hear exchanger, excessive rise of ambient temperature 2. Main PCB failure 3. Compressor failure (lock, winding short)
--

Check Point 1 : Check the outdoor unit fan operation, heat exchanger, ambient temperature
<ul style="list-style-type: none"> • No obstructions in air passages? • Heat exchange fins clogged • Outdoor unit fan motor check • Ambient temperature not raised by the effect of other heat sources? • Discharged air not sucked in?

↓ **OK**

Check Point 2: Replace Main PCB
▶ <u>If Check Point 1 do not improve the symptom, change Main PCB.</u>

↓ **OK**

Check Point 3: Replace Compressor
▶ <u>If Check Point 2 do not improve the symptom, change Compressor.</u>

Trouble shooting 17 <u>OUTDOOR UNIT Error Method:</u> Compressor motor control error	<u>Indicate or Display:</u> Refer to error code table.
---	---

<u>Detective Actuators:</u> Outdoor unit Main PCB Compressor	<u>Detective details:</u> ① If the detected rotor location is out of phase with actual rotor location more than 90°, the compressor stops. After the compressor restarts, if the same operation is repeated ② within 40sec, the compressor stops again. ③ If ① and ② repeats 5 times, the compressor stops permanently.
---	--

<u>Forecast of Cause :</u> 1. Defective connection of electric components 2. Main PCB failure 3. Compressor failure

Check Point 1 : Check Noise from Compressor
<ul style="list-style-type: none"> • Turn on Power and check operation noise. <p>▶ <u>If an abnormal noise show, replace Compressor.</u></p>



Check Point 2 : Check connection of around the Compressor components
For Compressor Terminal, Main PCB <ul style="list-style-type: none"> • Check if connector is removed. • Check erroneous connection. • Check if cable is open. (Refer to PARTS INFORMATION 2) >> <u>Upon correcting the removed connector or mis-wiring, reset the power.</u>



Check Point 3: Replace Main PCB
<p>▶ <u>If Check Point 1,2 do not improve the symptom, change Main PCB.</u></p>



Check Point 4: Replace Compressor
<p>▶ <u>If Check Point 3 do not improve the symptom, change Compressor.</u></p>

Trouble shooting 18 OUTDOOR UNIT Error Method: Outdoor unit fan motor error	Indicate or Display: Refer to error code table.
--	--

Detective Actuators: Outdoor unit Main PCB Outdoor unit Fan motor	Detective details: ① When outdoor fan rotation speed is less than 100rpm in 20 seconds after fan motor starts, fan motor stops. ② After fan motor restarts, if the same operation within 60sec is repeated 3 times in a row, compressor and fan motor stops. ③ If ① and ② repeats 5 times in a row, compressor and fan motor stops permanently.
--	---

Forecast of Cause: 1. Fan rotation failure 2. Motor protection by surrounding temperature rise 3. Main PCB failure 4. Outdoor unit fan motor

Check Point 1 : Check rotation of Fan
<ul style="list-style-type: none"> Rotate the fan by hand when operation is off. (Check if fan is caught, dropped off or locked motor) <p>>>If Fan or Bearing is abnormal, replace it.</p>



Check Point 2 : Check ambient temp. around motor
<ul style="list-style-type: none"> Check excessively high temperature around the motor. (If there is any surrounding equipment that causes heat) <p>>>Upon the temperature coming down, restart operation.</p>



Check Point 3 : Check Outdoor unit fan motor
<ul style="list-style-type: none"> Check Outdoor unit fan motor. (PARTS INFORMATION 5) <p>>>If Outdoor unit fan motor is abnormal, replace Outdoor unit fan motor.</p>



Check Point 4 : Check Output Voltage of Main PCB	DC																							
<ul style="list-style-type: none"> Check outdoor unit circuit diagram and the voltage. (Measure at Main PCB side connector) 																								
<table border="1" style="width: 100%;"> <tr> <td style="width: 30%;">CN800 [9/12/15RLFF]</td> <td style="width: 30%;"> <table border="1"> <tr><td>1</td><td>RED</td></tr> <tr><td>2</td><td></td></tr> <tr><td>3</td><td></td></tr> <tr><td>4</td><td>BLACK</td></tr> <tr><td>5</td><td>WHITE</td></tr> <tr><td>6</td><td>YELLOW</td></tr> <tr><td>7</td><td>BROWN</td></tr> </table> </td> <td style="width: 30%; text-align: center;"> </td> </tr> </table>		CN800 [9/12/15RLFF]	<table border="1"> <tr><td>1</td><td>RED</td></tr> <tr><td>2</td><td></td></tr> <tr><td>3</td><td></td></tr> <tr><td>4</td><td>BLACK</td></tr> <tr><td>5</td><td>WHITE</td></tr> <tr><td>6</td><td>YELLOW</td></tr> <tr><td>7</td><td>BROWN</td></tr> </table>	1	RED	2		3		4	BLACK	5	WHITE	6	YELLOW	7	BROWN		<table border="1" style="width: 100%;"> <thead> <tr> <th>Read wire</th> <th>DC voltage</th> </tr> </thead> <tbody> <tr> <td>Red - Black (Vm)</td> <td>240 - 400V (9/12/15RLFF)</td> </tr> <tr> <td>White - Black (Vcc)</td> <td>15 ± 1.5V</td> </tr> </tbody> </table>	Read wire	DC voltage	Red - Black (Vm)	240 - 400V (9/12/15RLFF)	White - Black (Vcc)
CN800 [9/12/15RLFF]	<table border="1"> <tr><td>1</td><td>RED</td></tr> <tr><td>2</td><td></td></tr> <tr><td>3</td><td></td></tr> <tr><td>4</td><td>BLACK</td></tr> <tr><td>5</td><td>WHITE</td></tr> <tr><td>6</td><td>YELLOW</td></tr> <tr><td>7</td><td>BROWN</td></tr> </table>	1	RED	2		3		4	BLACK	5	WHITE	6	YELLOW	7	BROWN									
1	RED																							
2																								
3																								
4	BLACK																							
5	WHITE																							
6	YELLOW																							
7	BROWN																							
Read wire	DC voltage																							
Red - Black (Vm)	240 - 400V (9/12/15RLFF)																							
White - Black (Vcc)	15 ± 1.5V																							
<p>▶ If the voltage is not correct, replace Main PCB.</p>																								

Trouble shooting 19 OUTDOOR UNIT Error Method: 4-way valve error	Indicate or Display: Refer to error code table.
---	--

Detective Actuators: Indoor unit Controller PCB Heat Ex. temperature thermistor Room temperature thermistor 4-way valve Main PCB	Detective details: When the indoor heat exchanger temperature is compared with the room temperature, and either following condition is detected continuously two times, the compressor stops. <ul style="list-style-type: none"> ▪ Cooling or Dry operation [Indoor heat exchanger temp.] - [Room temp.] > 20°F(10°C) ▪ Heating operation [Indoor heat exchanger temp.] - [room temp.] < - 20°F(-10°C) If the same operation is repeated 5 times, the compressor stops permanently.
--	---

Forecast of Cause : 1. Connector connection failure 2. Thermistor failure 3. Coil failure 4. 4-way valve failure 5. Main PCB failure 6. Controller PCB failure

Check Point 1 : Check connection of Connector <ul style="list-style-type: none"> ▪ Check if connector is removed. ▪ Check erroneous connection. ▪ Check if thermistor cable is open. >> <u>Upon correcting the removed connector or mis-wiring, reset the power.</u>
--



Check Point 2 : Check each thermistor <ul style="list-style-type: none"> ▪ Isn't it fallen off the holder? ▪ Is there a cable pinched? >> <u>Check characteristics of thermistor (Refer to Trouble shooting 5, 6), If defective, replace the thermistor</u>
--



Check Point 3 : Check the solenoid coil and 4-way valve [Solenoid coil] <ul style="list-style-type: none"> ▪ Remove CN30 (For 9/12RLFF) and CN500 (For 15RLFF) from PCB and check the resistance value of coil. Resistance value is 1.88kΩ ~ 2.29kΩ at 68°F (20°C). >> <u>If it is Open or abnormal resistance value, replace Solenoid Coil.</u> [4-way valve] <ul style="list-style-type: none"> ▪ Check each piping temperature, and the location of the valve by the temperature difference. >> <u>If the value location is not proper, replace 4-way valve.</u>
--



Check Point 4 : Check the voltage of 4-way valve <ul style="list-style-type: none"> ▪ Check the voltage CN30 (For 9/12RLFF) or CN500 (For 15RLFF) of Main PCB. Check if AC187V(AC208V-10%) - 253V(AC230V+10%) appears at CN 30 or CN500 of Main PCB. [Heating operation] >> <u>If it is not voltage, Replace Main PCB.</u> [Cooling operation] >> <u>If it is voltage, Replace Main PCB.</u>
--

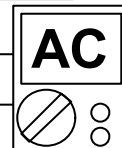

Check Point 5 : Replace Controller PCB ▶ <u>If Check Point 1- 4 do not improve the symptom, replace Controller PCB.</u>
--

Trouble shooting 20 OUTDOOR UNIT Error Method: Discharge temperature error	Indicate or Display: Refer to error code table.
---	--

Detective Actuators: Outdoor unit Main PCB Discharge temperature thermistor	Detective details: <ul style="list-style-type: none"> "Protection stop by "discharge temperature $\geq 230^{\circ}\text{F}(110^{\circ}\text{C})$ during compressor operation"" generated 2 times within 24 hours.
--	---

Forecast of Cause : <ul style="list-style-type: none"> 1. 3-way valve not opened 2. EEV defective, strainer clogged 3. Outdoor unit operation failure, foreign matter on heat exchanger 4. Discharge temperature thermistor failure 5. Insufficient refrigerant 6. Main PCB failure
--

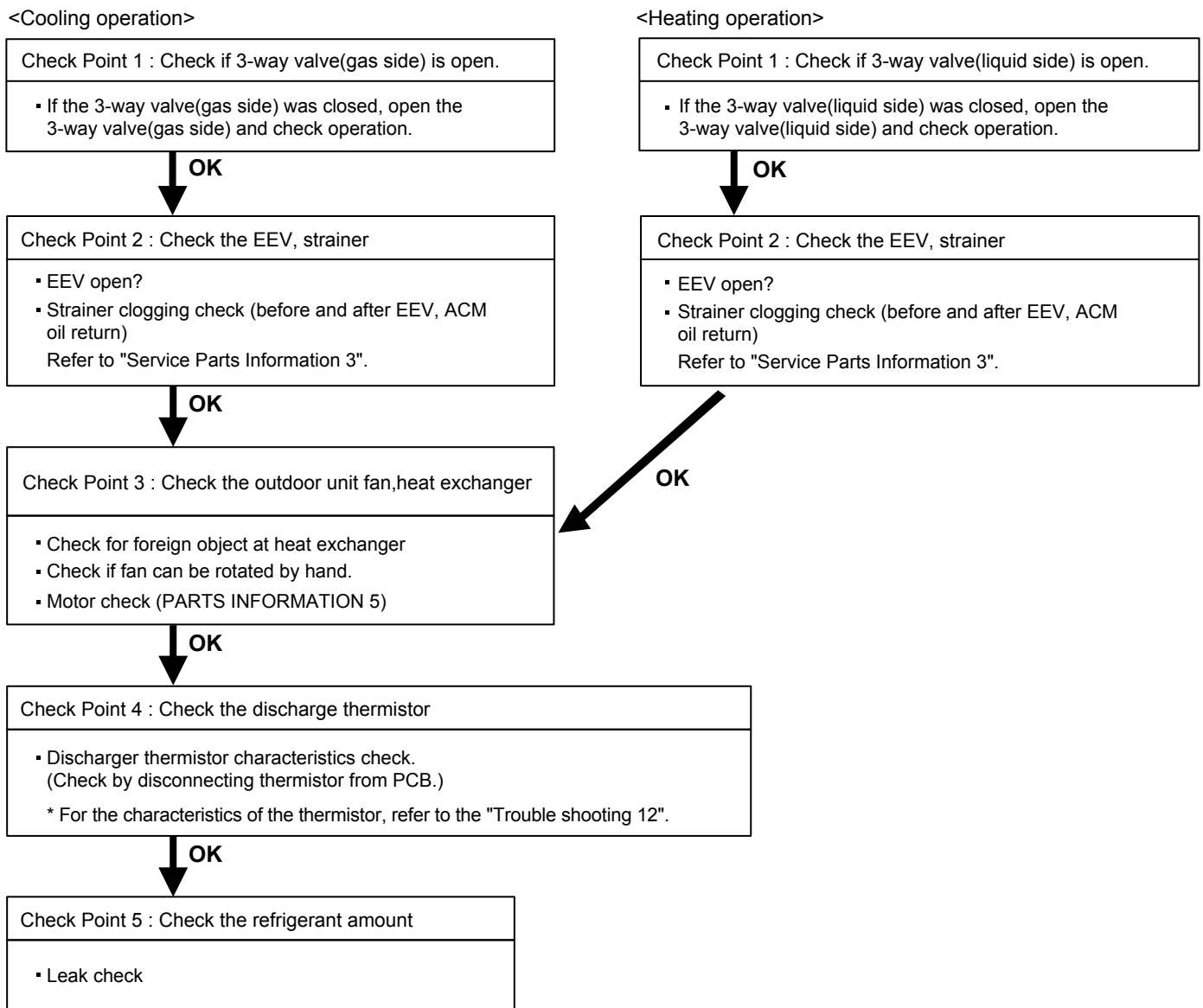

2-3 TROUBLE SHOOTING WITH NO ERROR CODE

Trouble shooting 21

Indoor Unit - No Power

Forecast of Cause:

1. Power supply failure
2. External cause
3. Electrical components defective

Check Point 1 : Check Installation Condition

- Isn't the breaker down?
- Check loose or removed connection cable.
- >> **If abnormal condition is found, correct it by referring to Installation Manual or Data & Technical Manual.**

↓
OK

Check Point 2 : Check external cause at Indoor and Outdoor (Voltage drop or Noise)

- Instant drop ----- Check if there is a large load electric apparatus in the same circuit.
- Momentary power failure ----- Check if there is a defective contact or leak current in the power supply circuit.
- Noise ----- Check if there is any equipment causing harmonic wave near electric line. (Neon bulb or electric equipment that may cause harmonic wave)
Check the complete insulation of grounding.

↓
OK

Check Point 3 : Check Electrical Components



- Check the voltage of power supply.
- >> **Check if AC187 - 253V appears at Outdoor Unit Terminal L - N.**

↓
YES

- Check Fuse in Main PCB.
>> **If Fuse is open, check if the wiring between Terminal and Main PCB is loose, and replace Fuse.**
- Check Varistor in Main PCB.
>> **If Varistor is defective, there is a possibility of an abnormal power supply. Check the correct power supply and replace Varistor. Upon checking the normal power supply, replace Varistor.**

Trouble shooting 22

Outdoor Unit - No Power

Forecast of Cause:

1. Power supply failure
2. External cause
3. Electrical Components defective

Check Point 1 : Check Installation Condition

- Isn't the breaker down?
- Check loose or removed connection cable.
- >>If abnormal condition is found, correct it by referring to Installation Manual or Data & Technical Manual.**

↓
OK

Check Point 2 : Check external cause at Indoor and Outdoor (Voltage drop or Noise)

- Instant drop ----- Check if there is a large load electric apparatus in the same circuit.
- Momentary power failure ----- Check if there is a defective contact or leak current in the power supply circuit.
- Noise ----- Check if there is any equipment causing harmonic wave near electric line.
(Neon bulb or electric equipment that may cause harmonic wave)
Check the complete insulation of grounding.

↓
OK

Check Point 3 : Check Electrical Components



- Check the voltage of power supply.
- >> Check if AC187 - 253V appears at Outdoor Unit Terminal L - N.**

↓
YES

- Check Fuse in Main PCB.
- >> If Fuse is open, check if the wiring between Terminal and Main PCB is loose, and replace Fuse.**
- Check Varistor in Main PCB.
- >> If Varistor is defective, there is a possibility of an abnormal power supply. Check the correct power supply and replace Varistor. Upon checking the normal power supply, replace Varistor.**

↓
OK

▶ **If the symptom does not change by above Check 3, replace Main PCB.**

Trouble shooting 23

No Operation (Power is ON)

Forecast of Cause:

1. Setting/ Connection failure
2. External cause
3. Electrical component defective

Check Point 1 : Check indoor and outdoor installation condition

- Indoor Unit - Check incorrect wiring between Indoor Unit - Remote Control.
Or, check if there is an open cable connection.
- Are these Indoor Unit, Outdoor Unit, and Remote Control suitable model numbers to connect?
>> If there is some abnormal condition, correct it by referring to Installation manual and Data & Technical Manual.

OK

Turn off Power and check/ correct followings.

- Is there loose or removed communication line of Indoor Unit and Outdoor Unit?

OK

Check Point 2 : Check external cause at Indoor and Outdoor (Voltage drop or Noise)

- Instant drop ----- Check if there is a large load electric apparatus in the same circuit.
- Momentary power failure ----- Check if there is a defective contact or leak current in the power supply circuit.
- Noise ----- Check if there is any equipment causing harmonic wave near electric line.
(Neon bulb or electric equipment that may cause harmonic wave)
Check the complete insulation of grounding.

OK

Check Point 3 : Check Electrical Components at Indoor and Outdoor

- Check Voltage at CN6 (terminal 1-3) of Controller PCB.
(Power supply to Remote Control)

- >> If it is DC13V, Remote Control is failure. (Controller PCB is normal) >> Replace Remote Control**
- >> If it is DC 0V, Controller PCB is failure. (Check Remote Control once again)**
 - >> Check Indoor unit fan motor. (PARTS INFORMATION 4)**
 - If it is normal, replace Controller PCB.
 - If it is abnormal, replace Indoor unit fan motor and Controller PCB.
- >> If the symptom does not change by above Check 1, 2, 3, replace Main PCB of Outdoor unit.**

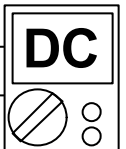

Trouble shooting 24

No Cooling / No Heating

Forecast of Cause:

1. Indoor Unit error
2. Outdoor Unit error
3. Effect by surrounding environment
4. Connection pipe / Connection wire failure
5. Refrigeration cycle failure

Check Point 1 : Check Indoor unit

- Does Indoor unit Fan run on High fan?
- Is Air filter dirty?
- Is Heat exchanger clogged?
- Check if Energy save function is operated.

↓ OK

Check Point 2 : Check Outdoor unit operation

- Check if Outdoor unit is operating
- Check any objects that obstruct the air flow route.
- Check clogged Heat Exchanger.
- Is the Valve open?

↓ OK

Check Point 3 : Check Site condition

- Is capacity of Indoor unit fitted to room size?
- Any windows open? or direct sunlight ?

↓ OK

Check Point 4 : Check Indoor/ Outdoor installation condition

- Check connection pipe (specified pipe length & Pipe diameter?)
- Check any loose or removed communication line.
- >> **If there is an abnormal condition, correct it by referring to Installation Manual or Data & Technical Manual.**

↓ OK

Check Point 5 : Check Refrigeration cycle

- Check if Strainer is clogged (Refer to the figure at right).
- Measure Gas Pressure and if there is a leakage, correct it.
- >> **When recharging the refrigerant, make sure to perform vacuuming, and recharge the specified amount.**
- Check EEV (PARTS INFORMATION 3)
- Check Compressor (PARTS INFORMATION 1,2)

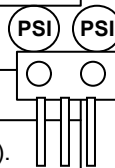

Attention

Strainer normally does not have temperature difference between inlet and outlet as shown in ①, but if there is a difference like shown in ②, there is a possibility of inside clogged. In this case, replace Strainer.

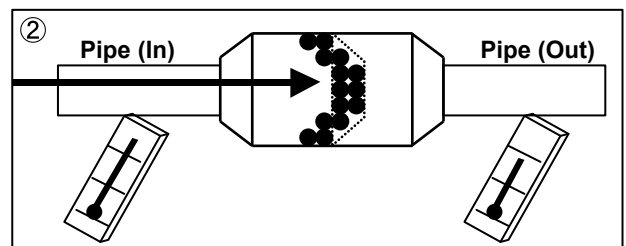
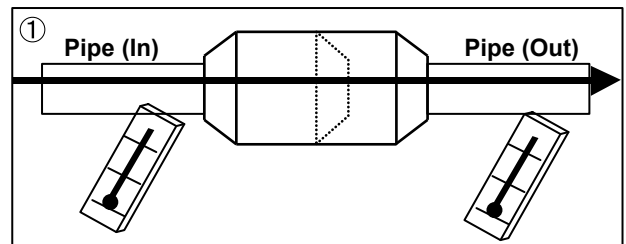

Trouble shooting 25

Abnormal Noise

Forecast of Cause :

1. Abnormal installation (Indoor/ Outdoor)
2. Fan failure (Indoor/ Outdoor)
3. Compressor failure (Outdoor)

Diagnosis method when abnormal noise is occurred

- Abnormal noise is coming from Indoor unit.
(Check and correct followings)

- Is Main unit installed in stable condition?
- Is the installation of air suction grille and front panel normal?

OK

- Is Fan broken or deformed?
- Is the screw of Fan loose?
- Is there any object which obstruct the Fan rotation?

- Abnormal noise is coming from Outdoor unit.
(Check and correct followings)

- Is Main unit installed in stable condition?
- Is Fan guard installed normally?

OK

- Is Fan broken or deformed?
- Is the screw of Fan loose?
- Is there any object which obstruct the Fan rotation?

OK

- Check if vibration noise by loose bolt or contact noise of piping is happening.

OK

- Is Compressor locked?
>> Check Compressor (PARTS INFORMATION 1,2)

Trouble shooting 26

Water Leaking

Forecast of Cause:

1. Erroneous installation
2. Drain hose failure

Diagnosis method when water leak occurs

- Is Main unit installed in stable condition?
- Is Main unit broken or deformed at the time of transportation or maintenance?

OK

- Is Drain hose connection loose?
- Is there a trap in Drain hose?
- Is Drain hose clogged?

OK

- Is Fan rotating?

Diagnosis method when water is spitting out.

- Is the filter clogged?

OK

- Check Gas pressure and correct it if there was a gas leak.

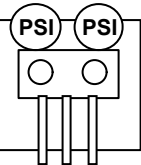

2-4 SERVICE PARTS INFORMATION

SERVICE PARTS INFORMATION 1

Compressor

Diagnosis method of Compressor (If Outdoor Unit LED displays Error, refer to Trouble shooting)

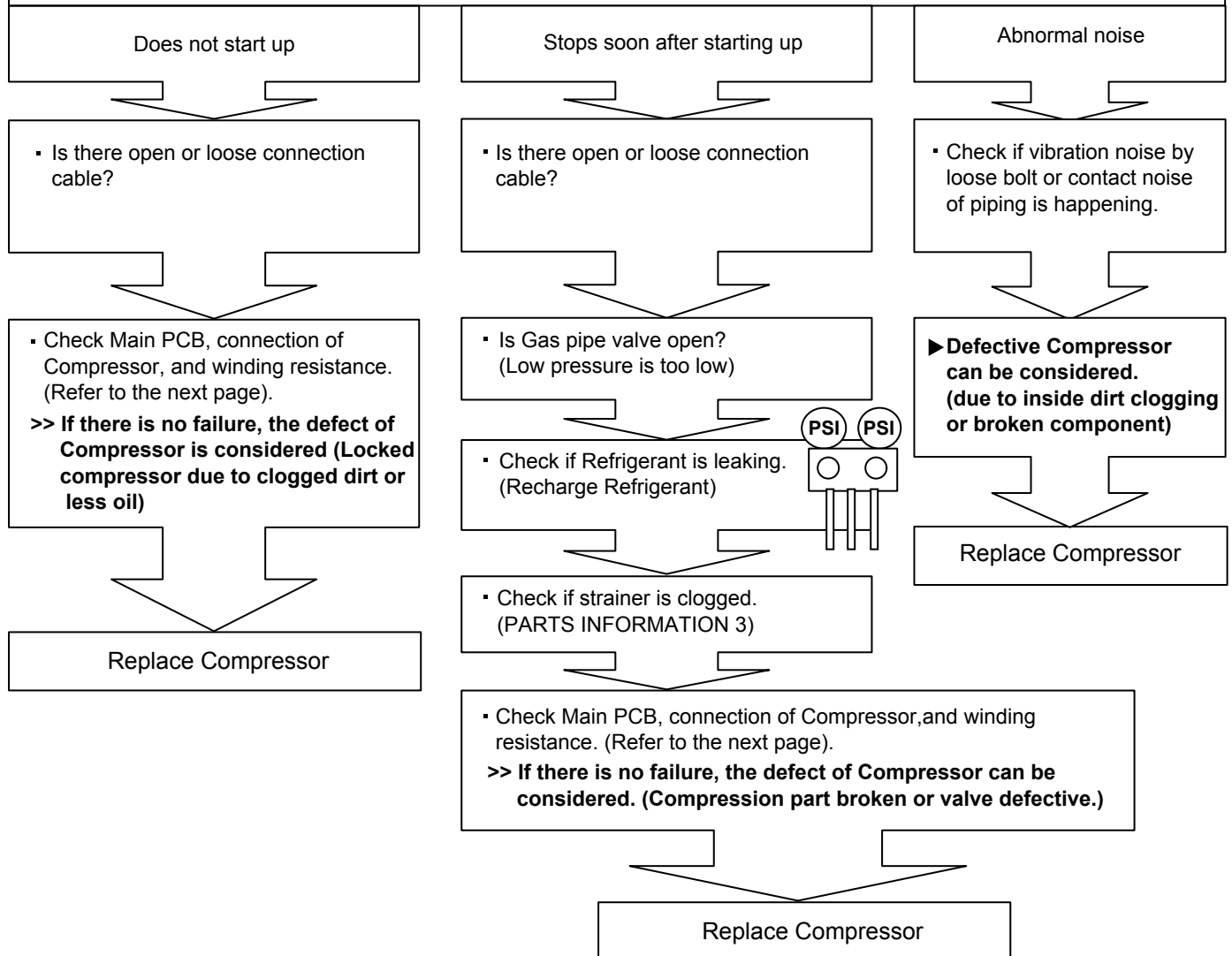

SERVICE PARTS INFORMATION 2

Compressor

Check Point 1 : Check Connection

- Check terminal connection of Compressor (loose or incorrect wiring)

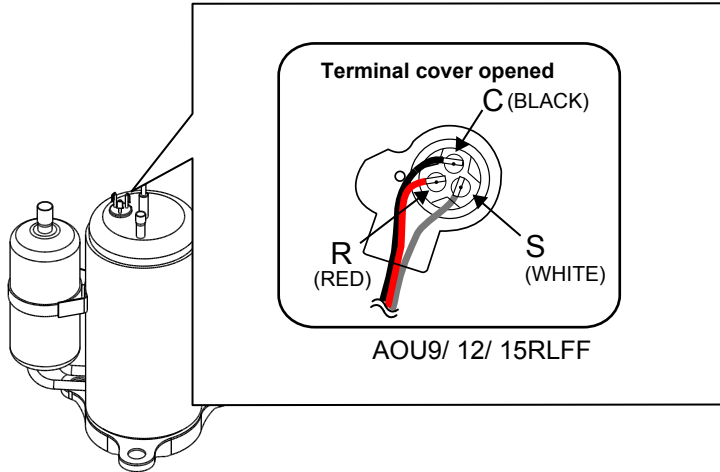

Check Point 2 : Check Winding Resistance

- Check winding resistance of each terminal

► **If the resistance value is 0Ω or infinite, replace Compressor.**

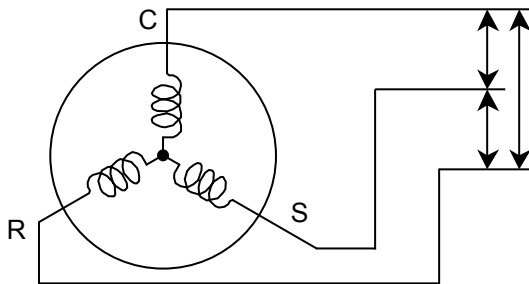
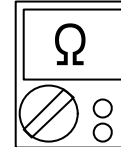

- **AOU9 / 12RLFF**
Resistance Value :
1.4Ω at 77°F(25°C)
- **AOU15RLFF**
Resistance Value :
0.7Ω at 77°F(25°C)

Check Point 3 : Replace Main PCB

► **If the symptom does not change with above Check 1, 2, replace Main PCB.**

SERVICE PARTS INFORMATION 3

Outdoor unit Electronic Expansion Valve (EEV)

Check Point 1 : Check Connections

- Check connection of connector (CN40 or CN700) (Loose connector or open cable)

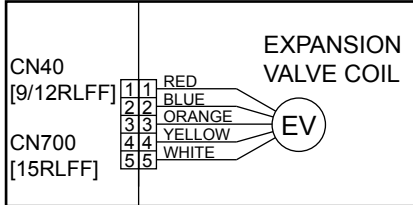

Check Point 2 : Check Coil of EEV

- Remove connector, check each winding resistance of Coil.

Read wire	Resistance value
White - Red	$46 \Omega \pm 4 \Omega$ at 68°F(20°C)
Yellow - Red	
Orange - Red	
Blue - Red	

► **If Resistance value is abnormal, replace EEV.**

Check Point 3 : Check Voltage from Main PCB.

- Remove Connector and check Voltage (DC12V)

► **If it does not appear, replace Main PCB.**



Check Point 4 : Check Noise at start up

- Turn on Power and check operation noise.

► **If an abnormal noise does not show, replace Main PCB.**

Check Point 5 : Check Opening and Closing Operation of Valve

When Valve is closed, it has a temp. difference between Inlet and Outlet.

CLOSE
Example : Hot Gas

Pipe (In)
Hi TEMP.

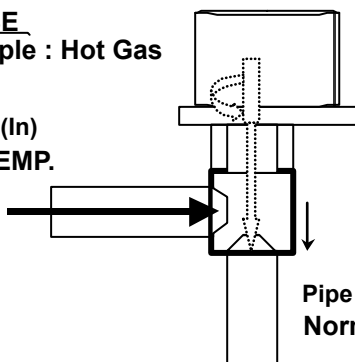

If it is open, it has no temp. difference between Inlet and Outlet.

OPEN
Example : Hot Gas

Pipe (In)
Hi TEMP.

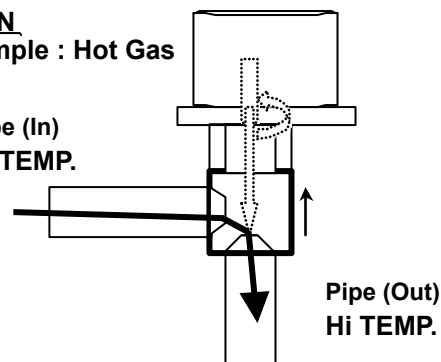

Check Point 6 : Check Strainer

Strainer normally does not have temperature difference between inlet and outlet as shown in ①, but if there is a difference as shown in ②, there is a possibility of inside clogged. In this case, replace Strainer.

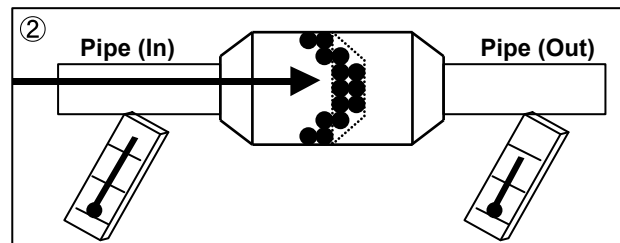
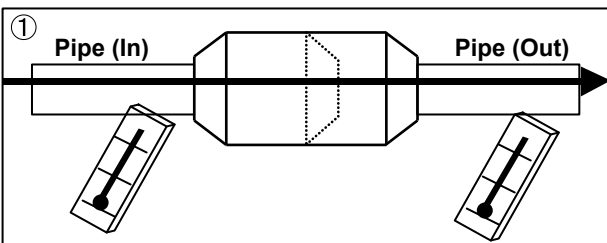

SERVICE PARTS INFORMATION 4

Indoor unit fan motor

Check Point 1 : Check rotation of Fan

- Rotate the fan by hand when operation is off.
(Check if fan is caught, dropped off or locked motor)
- >>If Fan or Bearing is abnormal, replace it.**

Check Point 2 : Check resistance of Indoor Fan Motor

- Refer to below. Circuit-test "Vm" and "GND" terminal.
(Vm: DC voltage, GND: Earth terminal)
- >>If they are short-circuited (below 300 k Ω), replace Indoor fan motor and Controller PCB.**

Pin number (wire color)	Terminal function (symbol)
1 (Blue)	Feed back (FG)
2 (Yellow)	Speed command (Vsp)
3 (White)	Control voltage (Vcc)
4 (Black)	Earth terminal (GND)
5	No function
6 (Red)	DC voltage (Vm)

SERVICE PARTS INFORMATION 5

Outdoor unit fan motor

Check Point 1 : Check rotation of Fan

- Rotate the fan by hand when operation is off.
(Check if fan is caught, dropped off or locked motor)
- >>If Fan or Bearing is abnormal, replace it.**

Check Point 2 : Check resistance of Outdoor Fan Motor

- Refer to below. Circuit-test "Vm" and "GND" terminal.
(Vm: DC voltage, GND: Earth terminal)
- >>If they are short-circuited (below 300 k Ω), replace Outdoor fan motor and Main PCB.**

Pin number (wire color)	Terminal function (symbol)
1 (Red)	DC voltage (Vm)
2	No function
3	No function
4 (Black)	Earth terminal (GND)
5 (White)	Control voltage (Vcc)
6 (Yellow)	Speed command (Vsp)
7 (Brown)	Feed back (FG)

For AOU15RLFF

SERVICE PARTS INFORMATION 6

Active filter module

Check Point 1 : Check Open or Short-circuit and Diode (D1)

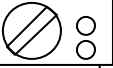

• Remove connector, check the open or short-circuit and the diode in the module

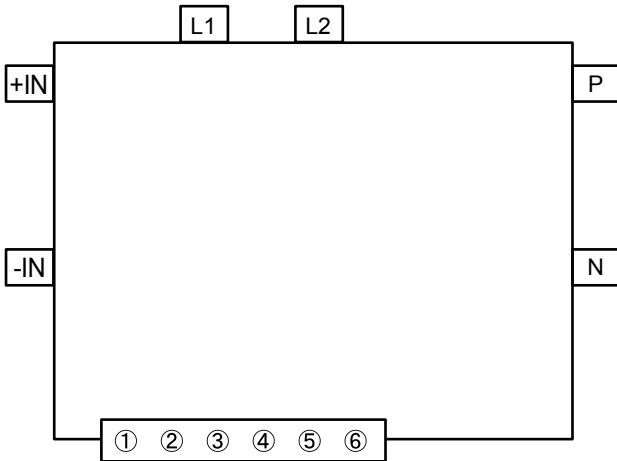

Check the open or short-circuit

Terminal		Resistance value
Tester(+)	Tester(-)	
(+IN)	(-IN)	360kΩ ± 20%
(-IN)	N	0 Ω
P	(+IN)	720kΩ ± 20%
L1	L2	1.40MΩ / 2.28MΩ (Ref. value 1) (Ref. value 2)
P	N	360kΩ ± 20%
L1,L2	Control Box	∞ Ω
L2	N	1.69MΩ / 1.88MΩ (Ref. value 1) (Ref. value 2)

Check the diode

Terminal		Resistance value
Tester(+)	Tester(-)	
L2	P	1.32MΩ / 1.50MΩ (Ref. value 1) (Ref. value 2)
P	L2	1.40MΩ / 1.51MΩ (Ref. value 1) (Ref. value 2)

□ By kind of tester, the value may change significantly.

Ref. value 1
Specifications for Multimeter
 Manufacturer : HIOKI
 Model name : 3804
 Power source : DC9V.

Ref. value 2
Specifications for Multimeter
 Manufacturer : YOKOGAWA
 Model name : 7534
 Power source : DC3V.

► **If it is abnormal,replace ACTIVE FILTER MODULE**

Check Point 2 : Check the Output DC voltage (between P and N)



• Check the Output DC voltage (between P and N) of compressor stopping and operating.
 >> If the output voltage of compressor operating is less than the output voltage of compressor stopping,
 Active Filter Module is defective. >> **Replace Active Filter Module**

For AOU15RLFF

SERVICE PARTS INFORMATION 7

IPM

(Mounted on Transistor PCB)

Check Point 1

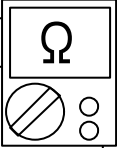

① Disconnect the connection wires between the Transistor PCB - Capacitor PCB and Transistor PCB - Inverter Compressor.

② Set the tester to the "Resistance" mode, and measure the resistance between the following terminals.

TM301 (P) - TM305(U) / TM304(V) / TM303(W)
 TM302 (N) - TM305(U) / TM304(V) / TM303(W)

③ Judge the result of ② as follows:

Terminal		Resistance value
Tester(+)	Tester(-)	
P	U	Over 2kΩ (Including ∞Ω)
P	V	
P	W	
U	P	Over 20kΩ (Including ∞Ω)
V	P	
W	P	
N	U	
N	V	Over 2kΩ (Including ∞Ω)
N	W	
U	N	
V	N	
W	N	

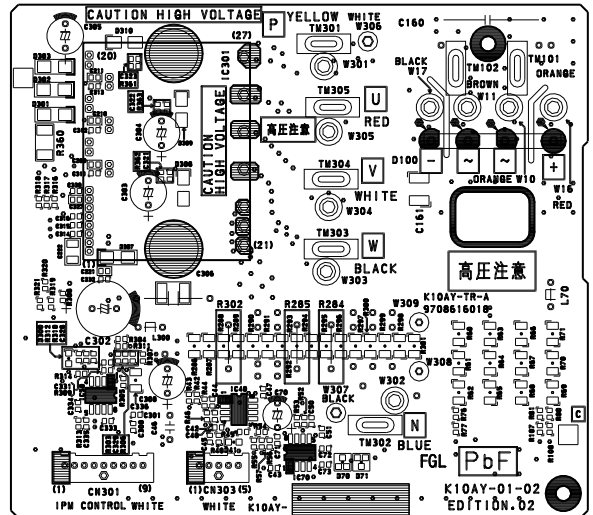

Check Point 2

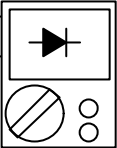

④ Set the tester to the "Diode" mode, and measure the voltage value between the following terminals.

⑤ Judge the result of ④ as follows:

Terminal		Tester display
Tester(+)	Tester(-)	
P	U	∞
P	V	
P	W	
U	P	0.3V~0.7V
V	P	
W	P	
N	U	
N	V	∞
N	W	
U	N	
V	N	
W	N	

FLOOR type INVERTER

3 . APPENDING DATA

3-1. FUNCTION SETTING

3-1-1 INDOOR UNIT

- Follow the instructions in the Local Setup Procedure, which is supplied with the remote control, in accordance with the installed condition.
After the power is turned on, perform the Function Setting on the remote control.
- The settings may be selected between the following two: Function Number or Setting Value.
- Settings will not be changed if invalid numbers or setting values are selected.

1-1. Setting the Filter sign

Select appropriate intervals for displaying the filter sign on the indoor unit according to the estimated amount of dust in the air of the room.
If the indication is not required, select "No indication" (03).

(◆ . . . Factory setting)

Setting Description	Function Number	Setting Value
Standard (400 hours)	11	00
Long interval (1000 hours)		01
Short interval (200 hours)		02
◆ No indication		03

1-2. Setting the Vertical airflow direction range control

In a concealed installation, change the setting to "Fixed" (02) to restrict the movement of the upper air outlet so that the airflow is only towards the horizontal direction.

(◆ . . . Factory setting)

Setting Description	Function Number	Setting Value
◆ Standard	23	00
(Setting prohibited)		01
Fixed (Concealed)		02

1-3. Setting the Room temperature control for cooling

Depending on the installed environment, correction of the room temperature sensor may be required.
Select the appropriate control setting according to the installed environment.

(◆ . . . Factory setting)

Setting Description	Function Number	Setting Value
◆ Standard	30	00
Slightly lower control		01
Lower control		02
Higher control		03

1-4. Setting the Room temperature control for heating

Depending on the installed environment, correction of the room temperature sensor may be required.
Select the appropriate control setting according to the installed environment.

(◆ . . . Factory setting)

Setting Description	Function Number	Setting Value
◆ Standard	31	00
Lower control		01
Slightly warmer control		02
Higher control		03

When using floor console installation, change the setting value to "01".

1-5. Setting the Auto restart

Enable or disable automatic restart after a power interruption.

(◆ . . . Factory setting)

Setting Description	Function Number	Setting Value
◆ Enable	40	00
Disable		01

* Auto restart is an emergency function such as for power outage etc.

Do not attempt to use this function in normal operation.

Be sure to operate the unit by remote controller or external input device.

1-6. Setting the Room temperature sensor switching

(Only for Wired remote controller)

When using the Wired remote controller temperature sensor, change the setting to "Both" (01).

(◆ . . . Factory setting)

Setting Description	Function Number	Setting Value
◆ Indoor unit	42	00
Both		01

* 00 : Sensor on the indoor unit is active.

* 01 : Sensors on both indoor unit and wired remote controller is active.

1-7. Setting the Remote controller signal code

(Only for wireless remote controller)

The indoor unit signal code can be changed. Select the appropriate signal code.

(◆ . . . Factory setting)

Setting Description	Function Number	Setting Value
◆ A	44	00
B		01
C		02
D		03

1-8. Setting the External input control

"Operation/Stop" mode or "Forced stop" mode can be selected.

(◆ . . . Factory setting)

Setting Description	Function Number	Setting Value
◆ Operation /Stop mode	46	00
(Setting prohibited)		01
Forced stop mode		02

1-9. Setting the Indoor unit fan control for energy saving for cooling

Enables or disables the power-saving function by controlling the indoor unit fan rotation when the outdoor unit is stopped during cooling operation.

(◆ . . . Factory setting)

Setting Description	Function Number	Setting Value
◆ Disable	49	00
Enable		01

* If setting value is "00" :

When the outdoor unit is stopped, the indoor unit fan operates continuously following the setting on the remote controller.

* If setting value is "01" :

When the outdoor unit is stopped, the indoor unit fan operates intermittently at a very low speed.

3-1-2 Procedures to change the Function Setting for wireless RC

Perform the "FUNCTION SETTING" according to the installation conditions using the remote controller.

- This procedure changes to the function settings used to control the indoor unit according to the installation conditions. Incorrect settings can cause the indoor unit to malfunction.
- After the power is turned on, perform the "FUNCTION SETTING" according to the installation conditions using the remote controller
- The settings may be selected between the following two: Function Number or Setting Value.
- Settings will not be changed if invalid numbers or setting values are selected.
- Refer to the installation manual enclosed with the remote controller when the wired remote controller (option) is used.

Entering the Function Setting Mode

- While pressing the POWERFUL button and SET TEMP.(\wedge) button simultaneously, press the RESET button to enter the function setting mode.

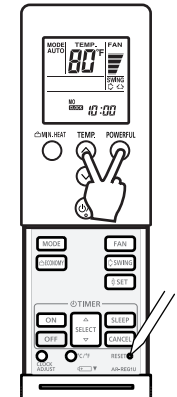

STEP 1

Selecting the Remote Controller Custom Code

Use the following steps to select the custom code of the remote controller.
(Note that the air conditioner cannot receive a custom code if the air conditioner has not been set for the custom code.)

The custom codes that are set through this process are applicable only to the signals in the FUNCTION SETTING. For details on how to set the custom codes through the normal process, refer to Remote controller custom code.

- (1) Press SET TEMP.(\wedge / \vee) button to change the custom code between $A \rightarrow b \rightarrow c \rightarrow d$. Match the code on the display to the air conditioner custom code. (initially set to A)
(If the custom code does not need to be selected, press the MIN.HEAT button and proceed to STEP 2.)
- (2) Press the MODE button and check that the indoor unit can receive signals at the displayed custom code.
- (3) Press the MIN.HEAT button to accept the custom code, and proceed to STEP 2.

The air conditioner custom code is set to A prior to shipment.
Contact your retailer to change the custom code.

The remote controller resets to custom code A when the batteries in the remote controller are replaced. If you use a custom code other than custom code A, reset the custom code after replacing the batteries.
If you do not know the air conditioner custom code setting, try each of the custom codes ($A \rightarrow b \rightarrow c \rightarrow d$) until you find the code which operates the air conditioner.

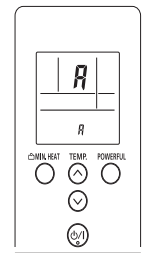

STEP 2

Selecting the Function Number and Setting Value

- (1) Press the SET TEMP. (\wedge / \vee) buttons to select the function number
(Press the MIN. HEAT button to switch between the left and right digits.)
- (2) Press the POWERFUL button to proceed to setting value.
(Press the POWERFUL button again to return to the function number selection.)
- (3) Press the SET TEMP.(\wedge / \vee) buttons to select the setting value.
(Press the MIN. HEAT button to switch between the left and right digits.)
- (4) Press the MODE button, and START/STOP button, in the order listed to confirm the settings.
- (5) Press the RESET button to cancel the function setting mode.
- (6) After completing the FUNCTION SETTING, be sure to turn off the power and turn it on again.

Function Number

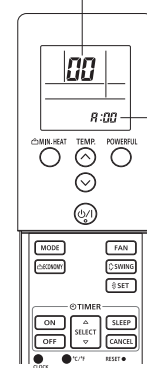

Setting Value

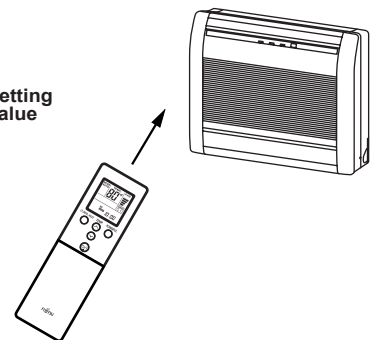

CAUTION

**After turning off the power, wait 10 seconds or more before turning on it again.
The FUNCTION SETTING doesn't become active unless the power is turned off then on again.**

■ FUNCTION SETTING METHOD (for Wired remote controller)

- (1) Press the SET TEMP. buttons (∇) (▲) and FAN button simultaneously for more than 5 seconds to enter the function setting mode.

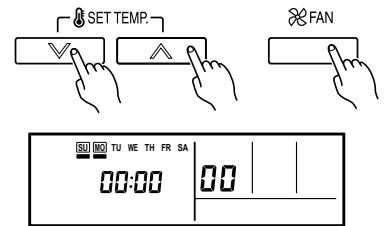

- (2) Press the SET BACK button to select the indoor unit number.

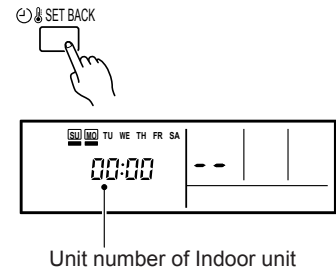

- (3) Press the Set time buttons to select the function number.

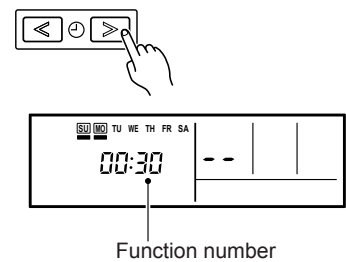

- (4) Press SET TEMP. buttons (∇) (▲) to select the setting value.
The display flashes as shown to the right during setting value selection.

- (5) Press the TIMER SET button to confirm the setting.
Press the TIMER SET button for a few seconds until the setting value stops flashing.
If the setting value display changes or if "--" is displayed when the flashing stops, the setting value has not been set correctly.
(An invalid setting value may have been selected for the indoor unit.)

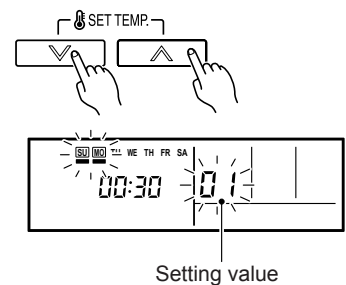

- (6) Repeat steps 2 to 5 to perform additional settings.
Press the SET TEMP. buttons (∇) (▲) and FAN button simultaneously again for more than 5 seconds to cancel the function setting mode.
In addition, the function setting mode will be automatically canceled after 1 minute if no operation is performed.

- (7) After completing the FUNCTION SETTING, be sure to turn off the power and turn it on again.

⚠ CAUTION

**After turning off the power, wait 30 seconds or more before turning on it again.
The FUNCTION SETTING doesn't become effective if it doesn't do so.**

3-2. Thermistor Resistance Values

3-2-1 INDOOR UNIT

Room temperature thermistor		
Temp °F(°C)	Resistance(k Ω)	Voltage(V)
14 (-10)	58.2	0.73
23 (-5)	44.0	0.93
32 (0)	33.6	1.15
41 (5)	25.9	1.39
50 (10)	20.2	1.66
59 (15)	15.8	1.94
68 (20)	12.5	2.22
77 (25)	10.0	2.50
86 (30)	8.0	2.77
95 (35)	6.5	3.03
104 (40)	5.3	3.27
113 (45)	4.4	3.49

Indoor heat exchanger thermistor		
Temp °F(°C)	Resistance(k Ω)	Voltage(V)
-22 (-30)	1131.9	0.21
-13 (-25)	804.5	0.29
-4 (-20)	579.6	0.40
5 (-15)	422.9	0.53
14 (-10)	312.3	0.69
23 (-5)	233.2	0.88
32 (0)	176.0	1.10
41 (5)	134.2	1.36
50 (10)	103.3	1.63
59 (15)	80.3	1.92
68 (20)	62.9	2.21
77 (25)	49.7	2.51
86 (30)	39.6	2.79
95 (35)	31.7	3.06
104 (40)	25.6	3.30
113 (45)	20.8	3.53
122 (50)	17.1	3.73
131 (55)	14.1	3.90
140 (60)	11.6	4.05
149 (65)	10.4	4.14

3-2-2 OUTDOOR UNIT

Discharge thermistor		
Temp °F(°C)	Resistance(k Ω)	Voltage(V)
-22 (-30)	1013.1	0.06
-12 (-25)	729.1	0.09
-4 (-20)	531.6	0.12
5 (-15)	392.3	0.16
14 (-10)	292.9	0.21
23 (-5)	221.1	0.28
32 (0)	168.6	0.36
41 (5)	129.8	0.46
50 (10)	100.9	0.57
59 (15)	79.1	0.71
68 (20)	62.5	0.86
77 (25)	49.8	1.03
86 (30)	40.0	1.23
95 (35)	32.4	1.43
104 (40)	26.3	1.65
113 (45)	21.6	1.88
122 (50)	17.8	2.11
131 (55)	14.8	2.34
140 (60)	12.3	2.57
149 (65)	10.3	2.79
158 (70)	8.7	3.00
167 (75)	7.4	3.19
176 (80)	6.3	3.37
185 (85)	5.4	3.54
194 (90)	4.6	3.69
203 (95)	4.0	3.83
212 (100)	3.4	3.96
221 (105)	3.0	4.07
230 (110)	2.6	4.17
239 (115)	2.3	4.26
248 (120)	2.0	4.33

Outdoor heat exchanger thermistor		
Temp °F(°C)	Resistance(k Ω)	Voltage(V)
-22 (-30)	95.6	0.24
-12 (-25)	68.9	0.32
-4 (-20)	50.3	0.43
5 (-15)	37.2	0.57
14 (-10)	27.8	0.73
23 (-5)	21.0	0.92
32 (0)	16.1	1.14
41 (5)	12.4	1.39
50 (10)	9.6	1.65
59 (15)	7.6	1.93
68 (20)	6.0	2.21
77 (25)	4.8	2.49
86 (30)	3.8	2.77
95 (35)	3.1	3.02
104 (40)	2.5	3.26
113 (45)	2.1	3.48
122 (50)	1.7	3.68
131 (55)	1.4	3.85
140 (60)	1.2	4.00
149 (65)	1.0	4.13
158 (70)	0.8	4.25
167 (75)	0.7	4.35
176 (80)	0.6	4.43

Outdoor temperature thermistor		
Temp °F(°C)	Resistance(k Ω)	Voltage(V)
-22 (-30)	224.3	0.73
-12 (-25)	159.7	0.97
-4 (-20)	115.2	1.25
5 (-15)	84.2	1.56
14 (-10)	62.3	1.90
23 (-5)	46.6	2.26
32 (0)	35.2	2.61
41 (5)	26.9	2.94
50 (10)	20.7	3.25
59 (15)	16.1	3.52
68 (20)	12.6	3.76
77 (25)	10.0	3.97
86 (30)	8.0	4.14
95 (35)	6.4	4.28
104 (40)	5.2	4.41
113 (45)	4.2	4.51
122 (50)	3.5	4.59
131 (55)	2.8	4.65

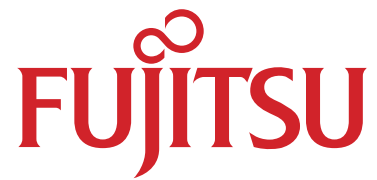

FUJITSU GENERAL LIMITED

1116, Suenaga, Takatsu-ku, Kawasaki 213-8502, Japan