



Submittal Data Sheet

1.5-Ton Wall Mounted Cooling Only
FAQ18TAVJURZR18TAVJU

INDOOR UNIT



OUTDOOR UNIT





Submittal Data Sheet

1.5-Ton Wall Mounted Cooling Only
FAQ18TAVJURZR18TAVJU

SYSTEM PERFORMANCE

Indoor Unit Model No.	FAQ18TAVJU	Indoor Unit Name:	Sky-Air Wall Mounted
Outdoor Unit Model No.	RZR18TAVJU	Outdoor Unit Name:	Sky-Air Cooling Only ODU
Rated Cooling Capacity (Btu/hr):	18,000	Rated Cooling Conditions:	Indoor (°F DB/WB): 80 / 67 Ambient (°F DB/WB): 95 / 75
Sensible Capacity (Btu/hr):	13,700	Rated Piping Length(ft):	25
Max/Min Cooling Capacity (Btu/hr):	/	Rated Height Difference (ft):	0.00
Cooling Input Power (kW):			
SEER (Non-Ducted/Ducted):	17.00 /		
EER (Non-Ducted/Ducted):	11.90 /		

SYSTEM DETAILS

Refrigerant Type:	R-410A	Cooling Operation Range (°F DB):	23 - 122
Holding Refrigerant Charge (lbs):	6.4	Heating Operation Range (°F WB):	-
Additional Charge (lb/ft):	0.04	Max. Pipe Length (Vertical) (ft):	98
Pre-charge Piping (Length) (ft):	15	Cooling Range w/Baffle (°F DB):	0 - 122
Max. Pipe Length (Total) (ft):	164	Heating Range w/Baffle (°F WB):	-
Max Height Separation (Ind to Ind ft):	0		



Submittal Data Sheet

1.5-Ton Wall Mounted Cooling Only
FAQ18TAVJURZR18TAVJU

INDOOR UNIT DETAILS

Power Supply (V/Hz/Ph):	208-230 / 60 / 1	Airflow Rate (H/L) (CFM):	500/400
Power Supply Connections:	L1, L2, Ground	Moisture Removal (Gal/hr):	
Min. Circuit Amps MCA (A):	0.5	Gas Pipe Connection (inch):	5/8
Max Overcurrent Protection (MOP) (A):	15	Liquid Pipe Connection (inch):	3/8
Dimensions (HxWxD) (in):	11-3/8 x 41-3/8 x 9-1/4	Condensate Connection (inch):	1/2
Net Weight (lb):	31	Sound Pressure (H/L) (dBA):	43/37
Ext. Static Pressure (Rated/Max) (inWg):	/	Sound Power Level (dBA):	

DIMENSIONAL DRAWING - INDOOR UNIT

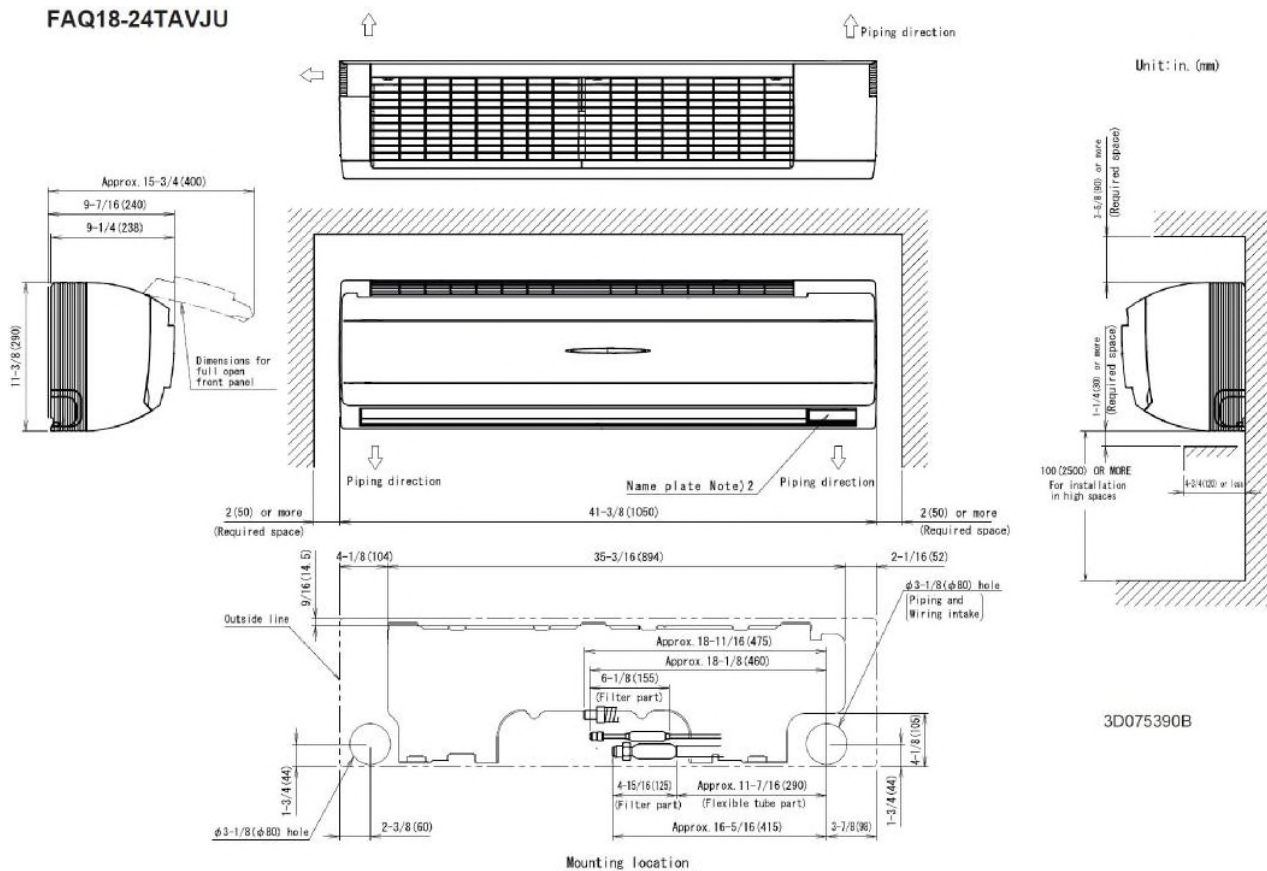

Daikin North America LLC, 5151 San Felipe, Suite 500, Houston, TX, 77056

Daikin City Generated Submittal Data

www.daikinac.com www.daikincomfort.com

(Daikin's products are subject to continuous improvements. Daikin reserves the right to modify product design, specifications and information in this data sheet without notice and without incurring any obligations)

Submittal Date: 6/3/2019 8:04:55 AM

Page 3 of 4



Submittal Data Sheet

1.5-Ton Wall Mounted Cooling Only
FAQ18TAVJURZR18TAVJU

OUTDOOR UNIT DETAILS

Power Supply (V/Hz/Ph):	208-230 / 60 / 1	Compressor Stage:	
Power Supply Connections:	L1, L2, Ground	Capacity Control Range (%):	14 - 100
Min. Circuit Amps MCA (A):	16.5	Airflow Rate (H) (CFM):	2682
Max Overcurrent Protection (MOP) (A):	25	Gas Pipe Connection (inch):	5/8
Max Starting Current MSC(A):		Liquid Pipe Connection (inch):	3/8
Rated Load Amps RLA(A):	15.3	Sound Pressure (H) (dBA):	58
Dimensions (HxWxD) (in):	39 x 37 x 12-5/8	Sound Power Level (dBA):	
Net Weight (lb):	172		

DIMENSIONAL DRAWING - OUTDOOR UNIT

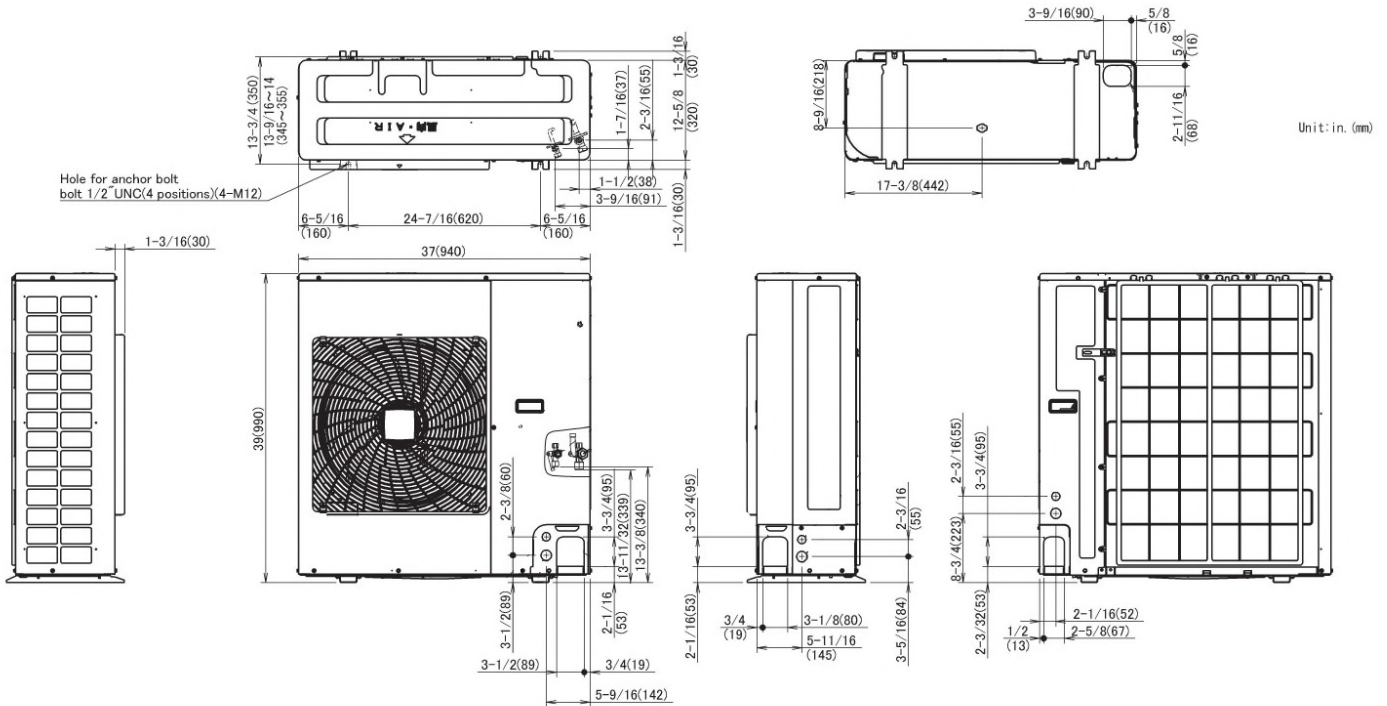

Daikin North America LLC, 5151 San Felipe, Suite 500, Houston, TX, 77056

Daikin City Generated Submittal Data

www.daikinac.com www.daikincomfort.com

(Daikin's products are subject to continuous improvements. Daikin reserves the right to modify product design, specifications and information in this data sheet without notice and without incurring any obligations)

Submittal Date: 6/3/2019 8:04:55 AM

Page 4 of 4