

# Installation and Operation Manual

## FRD Series

Inline Mixed Flow Rectangular Fans







Fantech Inc. certifies that the FRD Series shown herein is licensed to bear the AMCA Seal. The ratings shown are based on tests and procedures performed in accordance with AMCA Publication 211 and AMCA Publication 311 and comply with the requirements of the AMCA Certified Ratings Program.

### United States

10048 Industrial Blvd., Lenexa, KS, 66215  
Tel.: 800.747.1762 • Fax: 800.487.9915

### Canada

50 Kanalfakt Way, Bouctouche, NB, E4S 3M5  
Tel.: 800.565.3548 • Fax: 877.747.8116

				
Note	Warning / Important note	Information	Technical information	Practical tip



## WARNINGS

1. The compactness and adaptability of the FRD Series fans permit easy installation. The fans are shipped fully assembled and can be mounted at any angle. For various mounting, see figures on the following page.
2. Because this unit has rotating parts, safety precautions should be exercised during all phases of installation, operation and maintenance.
3. **CAUTION:** "For General Ventilation Use Only. Do Not Use To Exhaust Hazardous Or Explosive Material and Vapors."
4. Remove unit from package and inspect within 15 days after receipt. If damaged, report damage to carrier. Do Not operate this unit with visible damage to the blower or impeller assembly.
5. **CAUTION:** "This unit has an unguarded impeller. Do not use in locations readily accessible to people or animals".

### WEAR HAND PROTECTION AND STAY CLEAR OF SHARP EDGES!

6. Screen guards must be installed within reach of personnel, within (7) feet of the working area, or when advisable for safety.
7. **PLEASE** read the entire manual before installing.

### **DO NOT CONNECT POWER SUPPLY until fan is completely installed. Make sure electrical service to the fan is in the locked "OFF" position.**

1. All fans are suitable for use with solid-state speed control. Three phase units must be wired through a motor contactor.
2. **WARNING! TO REDUCE THE RISK OF FIRE, ELECTRIC SHOCK, OR INJURY TO PERSONS - OBSERVE THE FOLLOWING:**
  - a. Use this unit in the manner intended by the manufacturer. If you have any questions, contact your manufacturer's representative or contact us directly.
  - b. **CAUTION:** Before installation, servicing or cleaning unit, switch power off at service panel and lock the service disconnection means to prevent power from being switched on accidentally. When the service disconnection means cannot be locked, securely fasten a prominent warning device, such as tag, to the panel.
  - c. Installation work and electrical wiring must be done by qualified person(s) in accordance with all applicable codes and standards, including fire-rated construction.
  - d. Sufficient air is needed for proper combustion and exhausting of gases through the flue (chimney) of fuel burning equipment to prevent back drafting. Follow the heating equipment manufacturer's guideline and safety standards such as those published by the National Fire Association (NFPA), and the American Society for Heating, Refrigeration and Air-Conditioning Engineers (ASHRAE), and the local code authorities.
  - e. When cutting or drilling into wall and ceiling, do not damage electrical wiring and other hidden utilities.
  - f. Ducted fans must always be vented to the outdoors.
  - g. If this unit is to be installed over a tub or shower, it must be marked as appropriate for the application and be connected to a GFCI (Ground Fault Circuit Interrupter) - protected branch circuit.
  - h. NEVER place a switch where it can be reached from a tub or shower.
3. **WARNING!** Check voltage at the fan to see if it corresponds to the motor name plate.

## MOUNTING ILLUSTRATION 1

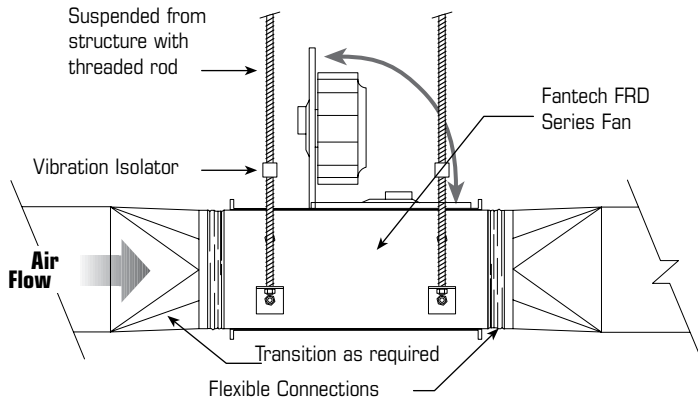

### Please follow all applicable codes when installing this unit

Please follow all applicable codes when installing this unit.

1. Determine the fan location and preferred mounting method.
2. If needed, install the included mounting bracket on fan. Be sure to use all four brackets and plug any unused holes.
3. Place fan in position and support with temporary fixture.
4. Connect fan to support structure. Vibration isolation mounts (supplied by others) are recommended.
5. Once fan is secure, temporary fixture can be removed.
6. Make duct connections. Flexible connectors (supplied by others) are recommended.
7. Make electrical connections according to the appropriate diagram on the next page.

## MOUNTING ILLUSTRATION 2

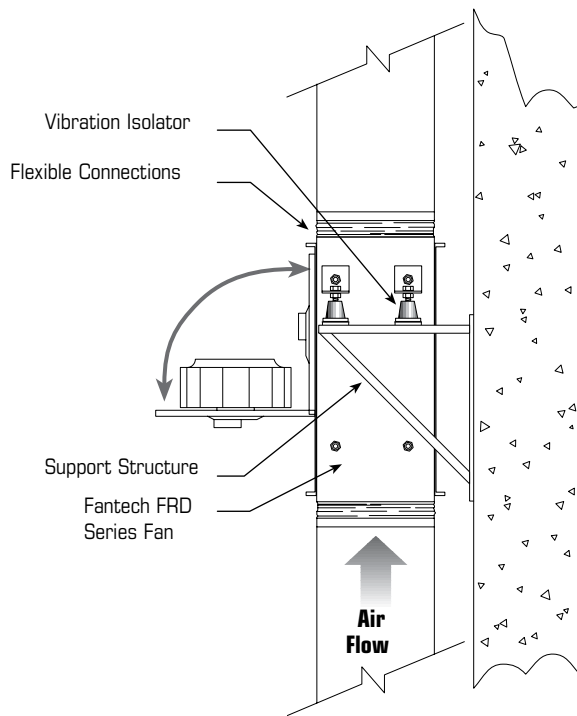

### Please follow all applicable codes when installing this unit.

1. Determine the fan location and preferred mounting method.
2. If needed, install the included mounting bracket on fan. Be sure to use all four brackets and plug any unused holes.
3. Place fan in position and support with temporary fixture.
4. Connect fan to support structure. Vibration isolation mounts (supplied by others) are recommended.
5. Once fan is secure, temporary fixture can be removed.
6. Make duct connections. Flexible connectors (supplied by others) are recommended.
7. Make electrical connections according to the appropriate diagram on the next page.

## MOUNTING ILLUSTRATION 3

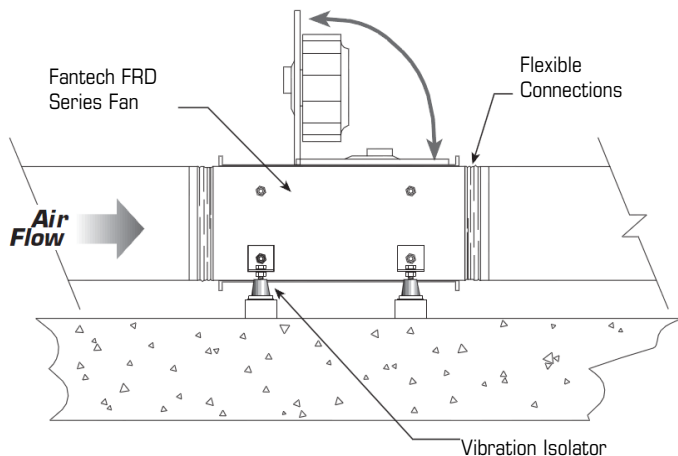

### Please follow all applicable codes when installing this unit.

1. Determine the fan location and preferred mounting method.
2. If needed, install the included mounting bracket on fan. Be sure to use all four brackets and plug any unused holes.
3. Place fan in position and support with temporary fixture.
4. Connect fan to support structure. Vibration isolation mounts (supplied by others) are recommended.
5. Once fan is secure, temporary fixture can be removed.
6. Make duct connections. Flexible connectors (supplied by others) are recommended.
7. Make electrical connections according to the appropriate diagram on the next page.

# DIMENSIONS AND WIRING

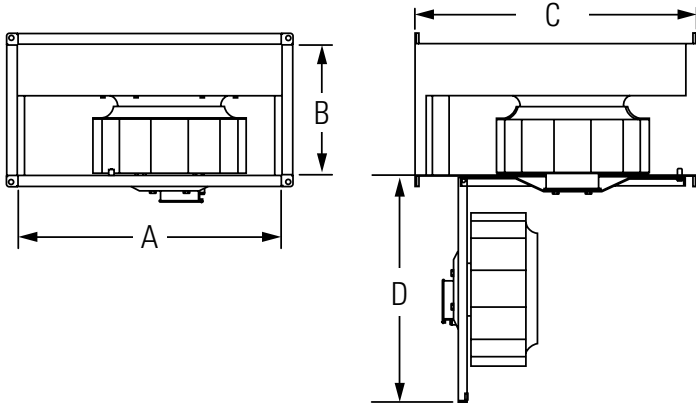

Model	A	B	C	D
FRD 12-6	11 7/8	5 7/8	15 3/4	11
FRD 12-8	15 3/4	7 3/4	19 3/4	15
FRD 16-8XL	15 3/4	7 3/4	19 3/4	15
FRD 20-10	19 5/8	9 3/4	20 3/8	18
FRD 24-14	23 5/8	13 3/4	28 1/2	20

All dimensions in inches.

## 120V

FRD 12-6, FRD 16-8, FRD 16-8XL & FRD 20-10

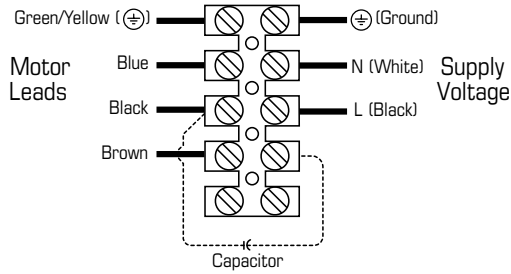

FRD 24-14

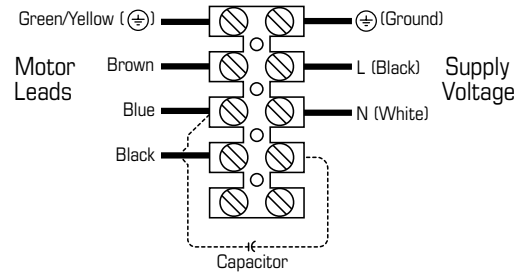

## 230V

FRD 12-6, FRD 16-8, FRD 16-8XL & FRD 20-10

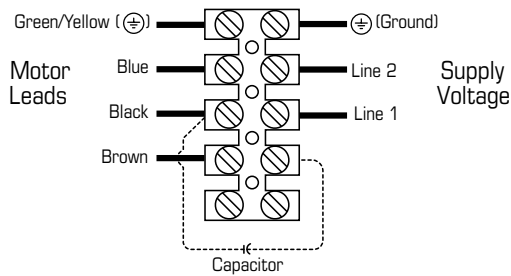

FRD 24-14

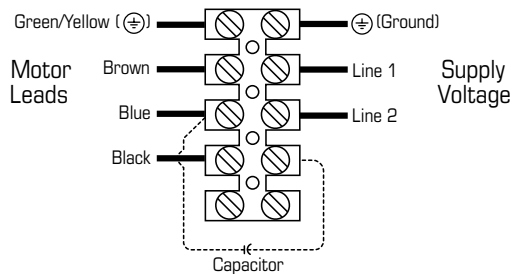

1. All leads are color coded.
2. Capacitor leads may be reversed. Fan operation will not be affected.

# WARRANTY

## Three (3) Year Warranty

**This warranty supersedes all prior warranties**

### **DURING ENTIRE WARRANTY PERIOD:**

Fantech will repair or replace any part which has a factory defect in workmanship or material. Product may need to be returned to the Fantech factory, together with a copy of the bill of sale and identified with RMA number.

### **FOR FACTORY RETURN YOU MUST:**

- Have a Return Materials Authorization (RMA) number. This may be obtained by calling Fantech either in the USA at 1.800.747.1762 or in CANADA at 1.800.565.3548. Please have bill of sale available.
- The RMA number must be clearly written on the outside of the carton, or the carton will be refused.
- All parts and/or product will be repaired/replaced and shipped back to buyer; no credit will be issued.

### **OR**

The Distributor may place an order for the warranty part and/or product and is invoiced. The Distributor will receive a credit equal to the invoice only after product is returned prepaid and verified to be defective.

FANTECH WARRANTY TERMS DO NOT PROVIDE FOR REPLACEMENT WITHOUT CHARGE PRIOR TO INSPECTION FOR A DEFECT. REPLACEMENTS ISSUED IN ADVANCE OF DEFECT INSPECTION ARE INVOICED, AND CREDIT IS PENDING INSPECTION OF RETURNED MATERIAL. DEFECTIVE MATERIAL RETURNED BY END USERS SHOULD NOT BE REPLACED BY THE DISTRIBUTOR WITHOUT CHARGE TO THE

## Limitation of Warranty and Liability

This warranty does not apply to any Fantech product or part which has failed as a result of faulty installation or abuse, incorrect electrical connections or alterations made by others, or use under abnormal operating conditions or misapplication of the product or parts. We will not approve for payment any repair not made by us or our authorized agent without prior written consent. The foregoing shall constitute our sole and exclusive warranty and our sole exclusive liability, and is in lieu of any other warranties, whether written, oral, implied or statutory. There are no warranties which extend beyond the description on the page hereof. In no event, whether as a result of breach of contract, or

## Warning

Fantech products are designed and manufactured to provide reliable performance, but they are not guaranteed to be 100% free from defects. Even reliable products will experience occasional failures and this possibility should be recognized by the user. If these products are

used in a life support ventilation system where failure could result in loss or injury, the user should provide adequate backup ventilation, supplementary natural ventilation, failure alarm system, or acknowledge willingness to accept the risk of such loss or injury.

END USER, AS CREDIT TO DISTRIBUTOR'S ACCOUNT WILL BE PENDING INSPECTION AND VERIFICATION OF ACTUAL DEFECT BY FANTECH.

### **THE FOLLOWING WARRANTIES DO NOT APPLY:**

- Damages from shipping, either concealed or visible. Claim must be filed with freight company.
- Damages resulting from improper wiring or installation.
- Damages or failure caused by acts of God, or resulting from improper consumer procedures, such as:
  1. Improper maintenance
  2. Misuse, abuse, abnormal use, or accident, and
  3. Incorrect electrical voltage or current.
- Removal or any alteration made on the Fantech label control number or date of manufacture.
- Any other warranty, expressed, implied or written, and to any consequential or incidental damages, loss or property, revenues, or profit, or costs of removal, installation or reinstallation, for any breach of warranty.

### **WARRANTY VALIDATION**

- The user must keep a copy of the bill of sale to verify purchase date.
- These warranties give you specific legal rights, and are subject to an applicable consumer protection legislation. You may have additional rights which vary from state to state.

warranty or alleged negligence, defect incorrect advice or other causes, shall Fantech be liable for special or consequential damages, including, but not limited to, loss of profits or revenue, loss of use of equipment or any other associated equipment, cost of capital, cost of substitute equipment, facilities or services, downtime costs, or claims of customers of purchase for such damages. Fantech neither assumes or authorizes any person to assume for it any other liability in connection with the sale of product(s) or part(s). Some jurisdictions do not allow the exclusion or limitation of incidental or consequential damages so the above limitations and exclusions may not apply to you.

used in a life support ventilation system where failure could result in loss or injury, the user should provide adequate backup ventilation, supplementary natural ventilation, failure alarm system, or acknowledge willingness to accept the risk of such loss or injury.

# NOTES

# NOTES

Fantech reserves the right to make technical changes.  
For updated documentation please refer to [www.fantech.net](http://www.fantech.net)

Fantech®

