



2019 KALEA Bay Fireplace

KALEA BAY – IN LIVING COLOR – 2019





KALEA BAY FOR 2019 FEATURES the others do not have

- **SHIPS AS SINGLE SIDED**
- **EASILY CONVERTIBLE TO SEE-THRU WITH OPTIONAL KIT**
- **BURNER SYSTEM CAN BE REMOVED FROM THE INSIDE OF THE FIREPLACE FOR SERVICE AND MAINTAINANCE**
- **LED LIGHTS ARE PROTECTED UNDER THE GLASS WINDSHEILD. NOT UNDER THE FLOOR LIKE OTHERS.**
- **Field convertible from NG to LP**

KALEA BAY FOR 2019 REFRESHED AND FEATURES ADD

- **LED LIGHTING**
- **ADJUSTABLE RED, GREEN, BLUE for FULL-SPECTRUM COLOR**
- **4 SIZES standard in Natural Gas.**
- **36" MODEL OFP-36LECO-NLED**
- **48" MODEL OFP-48LECO-NLED**
- **60" MODEL OFP-60LECO-NLED**
- **72" MODEL OFP-72LECO-NLED**
- **BUILT AS Natural Gas FIELD CONVERTIBLE to LP**
- **COMMERCIAL GRADE ECO-FLOW VALVE SYSTEM**
- **TETHERED CONTROL BOX WITH DOOR**
- **OPTIONAL STAINLESS STEEL WEATHER COVER**
- **OPTIONAL ON/OFF REMOTE CONTROL**

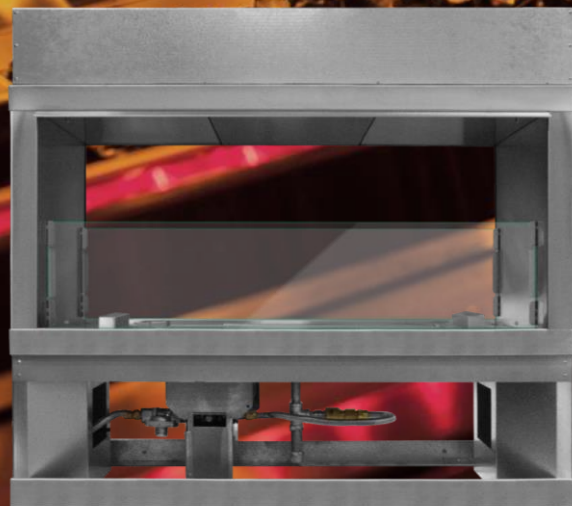
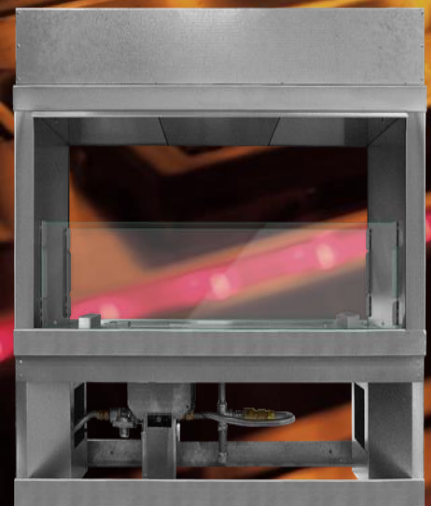
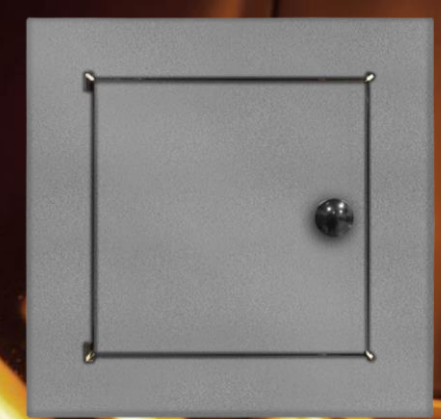

**GROWING OPPORTUNITY. SALES DOUBLED IN 2018:
DESIGN BUILD FIRMS – BUILDERS – SPECIALITY
RETAILERS – LANDSCAPE CONTRACTORS.
RESIDENTIAL AND COMMERCIAL APPLICATIONS**



ON SITE CABINET WAS BUILT FOR PHOTO with CERAMIC wood look tiles



KALEA BAY

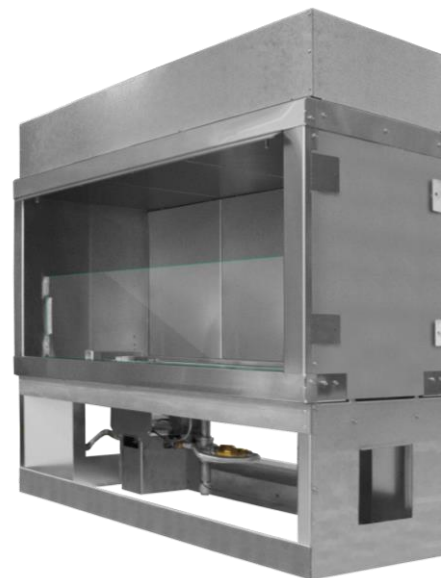
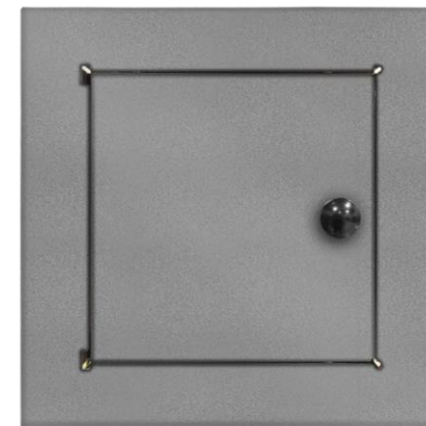
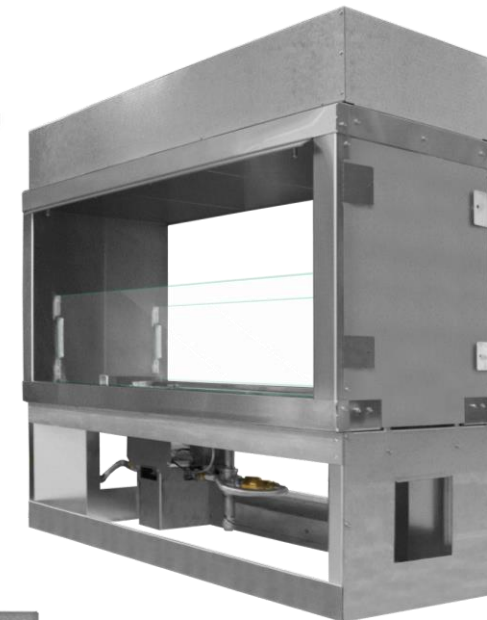

304 Stainless 6"x12" flat vents provided

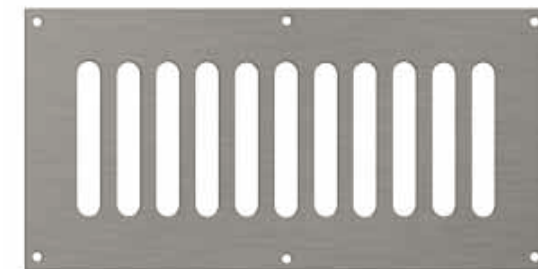

CONTROL CENTER

has 6' lead allowing it to be installed into side wall of on site built enclosure

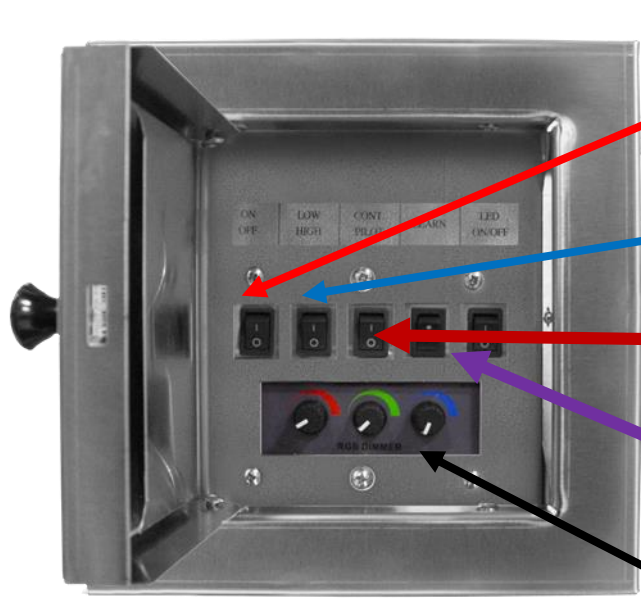

On / Off
Turn on and off the unit

Low / High
Control the flame height

Continuous Pilot
Keep the Pilot Light on

Learn
Add an accessory remote

R. G. B. Red Green Blue LED color adjustment

Mounting Cut-Out
Dimensions
5" Width x 5 5/8" Height

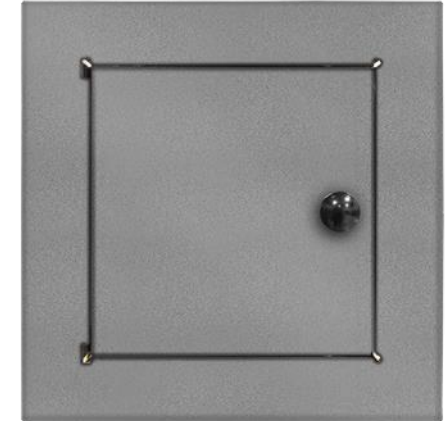

Electrical Power is needed to operate the fireplace

Step 1: Install the GFCI outlet double gang junction box with a weatherproof cover on the opposite side of the inlet gas supply.

NOTE: This is not a requirement; however, with the gang box on the opposite side of inlet will create more room for LED installation.

Figure 16 shows GFCI gang box installed.

The electric junction box (GFCI) with a weatherproof cover must be installed in the shaded area shown below. Ensure the j-box is close to the floor area where the fireplace is sitting and not touching the burner pan.

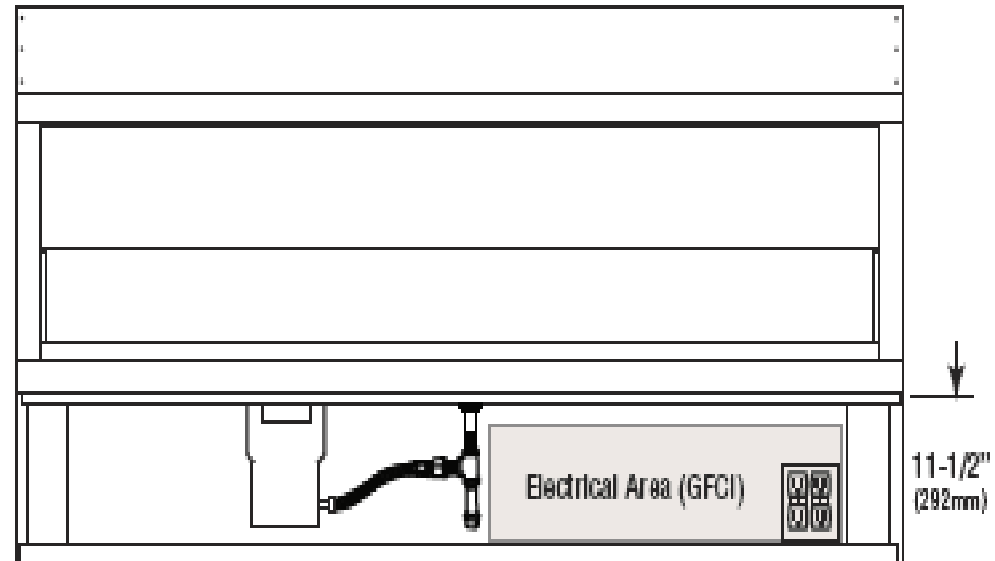

Figure 14 - Electrical Placement

36" Model = 13" (330mm)
48" Model = 18" (457mm)
60" Model = 24" (610mm)
72" Model = 30" (762mm)

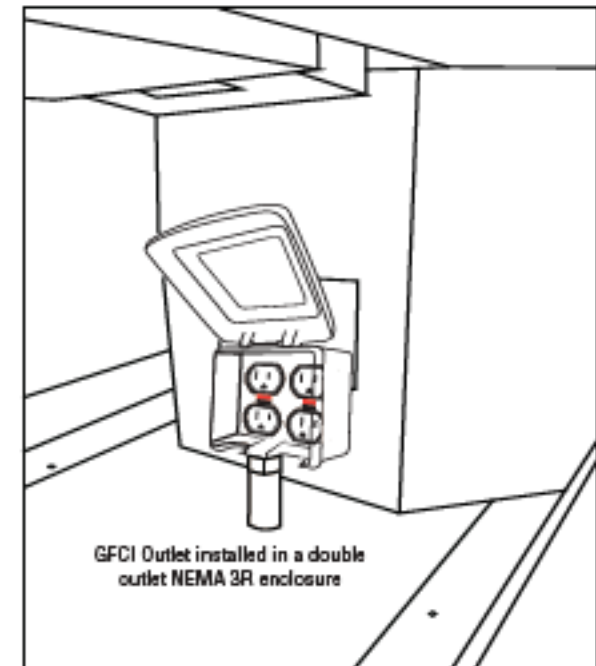
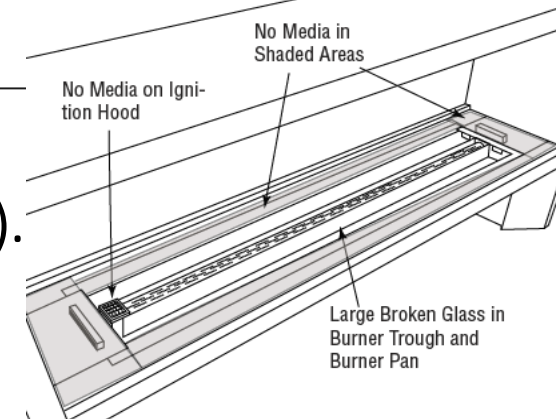
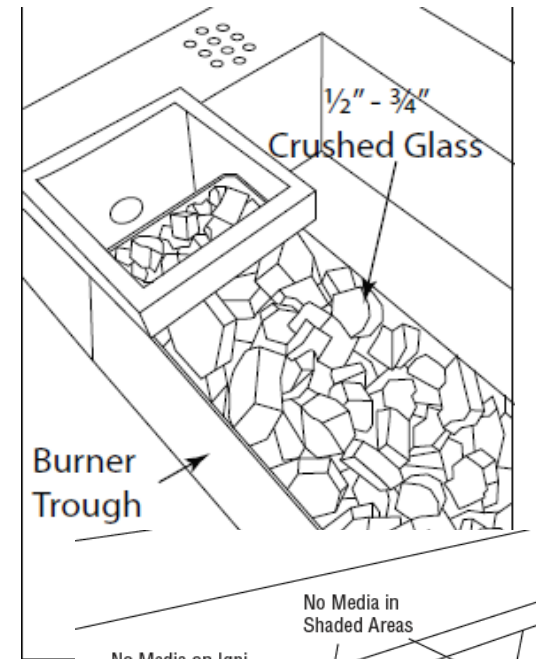
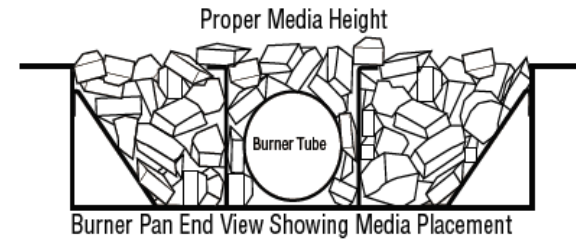

Figure 16 - Show GFCI box mounted in fireplace

Broken Glass will need to be purchased for the correct operation of the units.

- FIREPLACE Model # Cover the Entire Burner tube in Trough area Only
- OFP-36LECO-NLED 15lbs (3-5# bag)
- OFP-48LECO-NLED 20lbs (4-5# bag)
- OFP-60LECP-NLED 25lbs (5-5# bags)
- OFP-72LECO-NLED 30lbs (30-5# bags)



Media specifications. The Kalea Bay Requires Firegear glass

- Burner Trough (Cover the Entire burner tube in the pan filling the trough).
- Model GL 1/2" - 3/4" large broken glass
- Or Model GLR 1/2" - 3/4" large reflective glass
- Use the tables in the manual to assist in determining the amount of media needed for your specific model

OPTIONAL ACCESSORIES

You can easily convert your Kalea Bay into a see-through unit with one of our See-Through Conversion Kits.
See Through conversion Kits.

PART NUMBERS:

- 73230 36" Glass Windshield + Stainless Steel Hood
- 74230 48" Glass Windshield + Stainless Steel Hood
- 75230 60" Glass Windshield + Stainless Steel Hood
- 76230 72" Glass Windshield + Stainless Steel Hood



304 stainless Weather cover is made for all sizes. Need to purchase two for see through unit applications
PART # 36" unit **OFP-36CVO** / 48" unit **OFP-48COV** / 60" unit **OFP-60COV** / 72" unit **OFP-72COV**



"GL" Broken Glass
7 colors available



"GLR" Reflective
5 colors available



PART# PAVER-VENT-4LNTS Stainless vents for 4" block



PART# PAVER-VENT-6LNTS Stainless vents for 6" block