

PACKAGE GAS-ELECTRIC USER'S INFORMATION MANUAL



WARNING

IF THE INFORMATION IN THESE INSTRUCTIONS IS NOT FOLLOWED EXACTLY, A FIRE OR EXPLOSION MAY RESULT CAUSING PROPERTY DAMAGE, PERSONAL INJURY OR LOSS OF LIFE.

- Do NOT STORE OR USE GASOLINE OR OTHER FLAMMABLE VAPORS AND LIQUIDS IN THE VICINITY OF THIS OR ANY OTHER APPLIANCE.
- **WHAT TO DO IF YOU SMELL GAS:**
 - Do NOT TRY TO LIGHT ANY APPLIANCE.
 - Do NOT TOUCH ANY ELECTRICAL SWITCH; DO NOT USE ANY PHONE IN YOUR BUILDING.
 - IMMEDIATELY CALL YOUR GAS SUPPLIER FROM A NEIGHBOR'S PHONE. FOLLOW THE GAS SUPPLIER'S INSTRUCTIONS.
 - If YOU CANNOT REACH YOUR GAS SUPPLIER, CALL THE FIRE DEPARTMENT.
- INSTALLATION AND SERVICE MUST BE PERFORMED BY A QUALIFIED INSTALLER, SERVICE AGENCY OR THE GAS SUPPLIER.

Installer - Affix this manual, Installation Guide, and Warranty adjacent to the appliance.

Owner - Read and keep all product literature in a safe place for future reference.

WARNING

SHOULD OVERHEATING OCCUR, OR THE GAS SUPPLY FAIL TO SHUT OFF, SHUT OFF THE MANUAL GAS VALVE TO THE FURNACE BEFORE SHUTTING OFF THE ELECTRICAL SUPPLY.

WARNING

TO AVOID PROPERTY DAMAGE, PERSONAL INJURY OR DEATH, DO NOT USE THIS FURNACE IF ANY PART OF THE FURNACE HAS BEEN UNDER WATER. IMMEDIATELY CALL A QUALIFIED SERVICE TECHNICIAN TO INSPECT THE FURNACE AND TO REPLACE ANY PART OF THE CONTROL SYSTEM AND ANY GAS CONTROL HAVING BEEN UNDER WATER.

WARNING

PRODUCT CONTAINS FIBERGLASS WOOL. DISTURBING THE INSULATION IN THIS PRODUCT DURING INSTALLATION, MAINTENANCE, OR REPAIR WILL EXPOSE YOU TO FIBERGLASS WOOL. BREATHING THIS MAY CAUSE LUNG CANCER. (FIBERGLASS WOOL IS KNOWN TO THE STATE OF CALIFORNIA TO CAUSE CANCER.) FIBERGLASS WOOL MAY ALSO CAUSE RESPIRATORY, SKIN, AND EYE IRRITATION. TO REDUCE EXPOSURE OR FOR FURTHER INFORMATION, CONSULT MATERIAL SAFETY DATA SHEETS.

 **RECOGNIZE THIS SYMBOL AS A SAFETY PRECAUTION.**

HI-116E
7/15

Goodman Manufacturing Company, L.P.
5151 San Felipe, Suite 500, Houston, TX 77056
www.goodmanmfg.com

© 2004, 2007, 2009 - 2011, 2014 - 2015 Goodman Manufacturing Company, L.P.



SIGNAL WORDS

Dear Homeowner, please recognize the following safety information. This information will alert you to the potential for personal injury.

WARNING - Indicate hazards or unsafe practices which **COULD** result in severe personal injury or death.

WARNING

THIS PRODUCT CONTAINS OR PRODUCES A CHEMICAL OR CHEMICALS WHICH MAY CAUSE SERIOUS ILLNESS OR DEATH AND WHICH ARE KNOWN TO THE STATE OF CALIFORNIA TO CAUSE CANCER, BIRTH DEFECTS OR OTHER REPRODUCTIVE HARM.

WARNING

TO AVOID POSSIBLE EQUIPMENT DAMAGE, PERSONAL INJURY, FIRE OR DEATH, THE FOLLOWING INSTRUCTIONS MUST BE OBSERVED REGARDING UNIT LOCATION, AIR REQUIREMENTS AND OPERATING PROCEDURES.

WARNING

HEATING UNIT SHOULD NOT BE UTILIZED WITHOUT REASONABLE, ROUTINE, INSPECTION, MAINTENANCE AND SUPERVISION. IF THE BUILDING IN WHICH ANY SUCH DEVICE IS LOCATED WILL BE VACANT, CARE SHOULD BE TAKEN THAT SUCH DEVICE IS ROUTINELY INSPECTED, MAINTAINED AND MONITORED. IN THE EVENT THAT THE BUILDING MAY BE EXPOSED TO FREEZING TEMPERATURES AND WILL BE VACANT, ALL WATER-BEARING PIPES SHOULD BE DRAINED, THE BUILDING SHOULD BE PROPERLY WINTERIZED, AND THE WATER SOURCE CLOSED. IN THE EVENT THAT THE BUILDING MAY BE EXPOSED TO FREEZING TEMPERATURES AND WILL BE VACANT, ANY HYDRONIC COIL UNITS SHOULD BE DRAINED AS WELL AND, IN SUCH CASE, ALTERNATIVE HEAT SOURCES SHOULD BE UTILIZED.

Before using this manual, check the serial plate for proper model identification.

The installation and servicing of this equipment must be performed by qualified, experienced technicians only.

GENERAL INFORMATION

UNIT LOCATION

This unit is approved only for an outdoor installation. See the installation instructions for the required clearances to the unit. It is important that safety measures are taken in the surrounding area of the unit.

Gutters or deflectors must be installed on the roof to prevent water from shedding on the unit.

1. An area must be available to reach the unit in a clear and unobstructed path.
2. The unit area and the vicinity of any other gas appliances must be kept clear and free of combustible materials, gasoline, and other flammable vapors and liquids. Also, do not store or use flammable items such as paint, varnish, or lacquer in the area.
3. The combustion air supply must not be contaminated by products containing chlorine or fluorine, as they could corrode the heat exchanger. If you need further information on this subject, contact your installing dealer or another qualified servicer.
4. Familiarize yourself with the controls that turn off the gas and electrical power to the unit.
5. Establish a regular service and maintenance schedule to ensure efficient and safe operation of the unit.
6. The unit must be placed where no runoff water from higher ground can collect in the unit.

UNIT INSTALLATION

Examine the unit installation to determine the following:

1. The flue hood connector is in place and is physically sound without holes or excessive corrosion.
2. The mounting pad support of the unit is sound.
3. There are no obvious signs of deterioration of the unit.
4. The burner flames are stable, soft and blue, (dust may cause orange tips but must not be yellow). The flames should extend directly outward from the burner without curling, floating, or lifting off. To examine, turn on the electrical power and gas. Set the room temperature to the maximum setting.

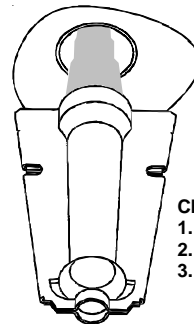

- Check the burner flames for:
1. Good adjustment
 2. Stable, soft and blue
 3. Not curling, floating, or lifting off.

Burner

NOTE: If a strong wind is blowing, it may not be possible to perform the flame inspection.



WARNING

TO AVOID PERSONAL INJURY OR FIRE, MINIMUM CLEARANCES TO COMBUSTIBLE SURFACES MUST BE FOLLOWED.

AIR REQUIREMENTS



WARNING

TO AVOID PROPERTY DAMAGE, PERSONAL INJURY OR DEATH, SUFFICIENT FRESH AIR MUST BE SUPPLIED FOR PROPER COMBUSTION AND VENTILATION OF FLUE GASES.

Since the gas/electric unit is installed completely in the outdoors, the depletion of combustion air is highly improbable. To ensure an adequate supply of combustion air, do not allow the combustion air inlet or the flue hood outlet to become blocked by leaves, snow, rubbish, or insect (wasps) nests. Never block the condensing unit section in the winter with covers. Blocking of this section would prevent an adequate amount of combustion air from reaching the furnace section.

Great care has been taken in the design and manufacture of your unit to provide for your comfort and safety. Be aware of the possibility that some problems with your unit or other gas-fired appliances could cause flue gases to be present in your building. These flue gases could include carbon monoxide.



WARNING

PERSONAL INJURY OR DEATH FROM ASPHYXIATION CAN RESULT FROM EXPOSURE TO CARBON MONOXIDE. CARBON MONOXIDE OR "CO" IS A COLORLESS AND ODORLESS GAS PRODUCED WHEN FUEL IS NOT BURNED COMPLETELY OR WHEN THE FLAME DOES NOT RECEIVE SUFFICIENT OXYGEN. BE AWARE OF THESE AIR STARVATION SIGNALS WHICH INDICATE CONDITIONS THAT MAY RESULT IN CARBON MONOXIDE OR THAT CARBON MONOXIDE MAY BE PRESENT:

1. HEADACHES-NAUSEA-DIZZINESS, FLU-LIKE SYMPTOMS.
2. EXCESSIVE HUMIDITY-HEAVILY FROSTED WINDOWS OR A MOIST "CLAMMY" FEELING IN THE HOME.
3. SMOKE FROM A FIREPLACE WILL NOT DRAW UP THE CHIMNEY.
4. FLUE GASES THAT WILL NOT DRAW UP THE APPLIANCE VENT PIPE.



WARNING

TO PREVENT PROPERTY DAMAGE OR SERIOUS PERSONAL INJURY DUE TO FIRE OR EXPLOSION CAUSED BY A PROPANE GAS LEAK, INSTALL A GAS DETECTING WARNING DEVICE.

IF THE PROPANE GAS UNIT IS INSTALLED IN AN EXCAVATED AREA OR A CONFINED SPACE, A WARNING DEVICE IS REQUIRED DUE TO:

- PROPANE GAS IS HEAVIER THAN AIR AND ANY LEAKING GAS CAN SETTLE IN ANY LOW AREAS OR CONFINED SPACES.
- PROPANE GAS ODORANT MAY FADE, MAKING THE GAS UNDETECTABLE EXCEPT WITH A WARNING DEVICE.



WARNING

AN UNDETECTED GAS LEAK WILL CREATE A DANGER OF EXPLOSION OR FIRE. IF THE PRESENCE OF GAS IS SUSPECTED, FOLLOW THE INSTRUCTIONS ON THE COVER OF THIS MANUAL. FAILURE TO DO SO COULD RESULT IN SERIOUS PERSONAL INJURY OR DEATH.

DANGER

CARBON MONOXIDE POISONING HAZARD

Special Warning for Installation of Furnace or Air Handling Units in Enclosed Areas such as Garages, Utility Rooms or Parking Areas

Carbon monoxide producing devices (such as an automobile, space heater, gas water heater, etc.) should not be operated in enclosed areas such as unventilated garages, utility rooms or parking areas because of the danger of carbon monoxide (CO) poisoning resulting from the exhaust emissions. If a furnace or air handler is installed in an enclosed area such as a garage, utility room or parking area and a carbon monoxide producing device is operated therein, there must be adequate, direct outside ventilation.

This ventilation is necessary to avoid the danger of CO poisoning which can occur if a carbon monoxide producing device continues to operate in the enclosed area. Carbon monoxide emissions can be (re)circulated throughout the structure if the furnace or air handler is operating in any mode.

CO can cause serious illness including permanent brain damage or death.

B10259-216

DANGER PELIGRO

RIESGO DE INTOXICACIÓN POR MONÓXIDO DE CARBONO

Advertencia especial para la instalación de calentadores ó manejadoras de aire en áreas cerradas como estacionamientos ó cuartos de servicio.

Los equipos ó aparatos que producen monóxido de carbono (tal como automóvil, calentador de gas, calentador de agua por medio de gas, etc) no deben ser operados en áreas cerradas debido al riesgo de envenenamiento por monóxido de carbono (CO) que resulta de las emisiones de gases de combustión. Si el equipo ó aparato se opera en dichas áreas, debe existir una adecuada ventilación directa al exterior. Esta ventilación es necesaria para evitar el peligro de envenenamiento por CO, que puede ocurrir si un dispositivo que produce monóxido de carbono sigue operando en el lugar cerrado.

Las emisiones de monóxido de carbono pueden circular a través del aparato cuando se opera en cualquier modo.

El monóxido de carbono puede causar enfermedades severas como daño cerebral permanente ó muerte.

B10259-216

DANGER

RISEQUE D'EMPOISONNEMENT AU MONOXYDE DE CARBONE

Advertencia especial para la instalación de calentadores ó manejadoras de aire en áreas cerradas como estacionamientos ó cuartos de servicio.

Avertissement special au sujet de l'installation d'appareils de chauffage ou de traitement d'air dans des endroits clos, tels les garages, les locaux d'entretien et les stationnements. Evitez de mettre en marche les appareils produisant du monoxyde de carbone (tels que les automobile, les appareils de chauffage autonome, etc.) dans des endroits non ventilés tels que les d'empoisonnement au monoxyde de carbone. Si vous devez faire fonctionner ces appareils dans un endroit clos, assurez-vous qu'il y ait une ventilation directe provenant de l'exterieur.

Cette ventilation est nécessaire pour éviter le danger d'intoxication au CO pouvant survenir si un appareil produisant du monoxyde de carbone continue de fonctionner au sein de la zone confinée.

Les émissions de monoxyde de carbone peuvent être recirculés dans les endroits clos, si l'appareil de chauffage ou de traitement d'air sont en marche.

Le monoxyde de carbone peut causer des maladies graves telles que des dommages permanents au cerveau et même la mort.

B10259-216

THERMOSTAT

This unit will not operate properly without a good quality, correctly installed thermostat. It is very important that the thermostat be located where it can best “sense” the average room temperature. Be sure the thermostat is not exposed to hot or cold drafts or to hot or cold spots on the wall, such as those received from outside walls, walls with pipes inside, or from openings into the attic.

No matter the type or style, thermostat operation is basically the same. The most widely used types will control both heating and cooling functions and will have a Fan Switch with Auto and ON settings. On Auto, the Circulating Air Blower will cycle on/off, but if switched to ON it will run constantly.

For Dual Fuel units (GPD/APD), a Dual Fuel thermostat with an outdoor temperature sensor is recommended for optimal operation.

IMPORTANT NOTE: To avoid the possibility of damage to the unit heat exchanger, do not set the thermostat fan switch to ON (constant fan operation) during the heating season without first consulting the installer of the unit or another qualified servicer.

There are thermostats that automatically switch from Heating to Cooling, or with night setbacks. The night setback, or multiple setback type, will lower the temperature at night or during the day when the building is unoccupied.

Propane (LP) Gas Installations Only

For units operating on propane gas, please review the following warnings before use.

WARNING

TO AVOID PROPERTY DAMAGE, PERSONAL INJURY OR DEATH DUE TO EXPLOSION OR FIRE, INSTALL A GAS DETECTING WARNING DEVICE. SINCE THE ODORANT IN PROPANE GAS CAN BE REDUCED BY IRON OXIDE (RUST), A GAS DETECTING WARNING DEVICE IS THE ONLY RELIABLE METHOD TO DETECT PROPANE GAS LEAKS.

OPERATING INSTRUCTIONS

WARNING

ELECTRICAL COMPONENTS ARE CONTAINED IN BOTH COMPARTMENTS. TO AVOID PERSONAL INJURY, ELECTRICAL SHOCK OR DEATH, DO NOT REMOVE ANY INTERNAL COMPARTMENT COVERS. CONTACT A QUALIFIED SERVICER AT ONCE IF AN ABNORMAL CONDITION IS NOTICED.

WARNING

AN UNDETECTED GAS LEAK CAN CREATE A DANGER OF EXPLOSION OR FIRE. THE UNIT AND ITS GAS CONNECTIONS MUST BE LEAK TESTED BEFORE PLACING IN OPERATION.

HEATING START UP

To put your unit into operation, follow the steps listed below.

1. Close the external manual gas shutoff valve.
2. Turn off the electrical power to the unit.
3. Set the room thermostat to the lowest possible setting.
4. Remove the heat exchanger door on the side of the unit by removing screws.
5. This unit is equipped with an ignition device which automatically lights the burner. Do not try to light the burner by hand.

6. Move the gas control switch to the OFF position. Do not use excessive force.
7. Wait five minutes to clear out any gas. Then smell for gas, including near the floor as some types of gas are heavier than air.
8. If you smell gas following the five minute waiting period in step 7, immediately follow the instructions on the cover of this manual. If you do not smell gas after five minutes, move or rotate the gas control switch to the ON position. The switch should turn easily. Do not use excessive force.
9. Reinstall the burner compartment door.
10. Open the external manual gas shutoff valve.
11. Turn on the electrical power to the unit.
12. Adjust the thermostat to a setting above room temperature.
13. After the burners are lit, set the thermostat to desired temperature.

HEATING SHUT DOWN

To shut down operation, follow the steps listed below.

1. Set the thermostat to the lowest setting.
2. Turn OFF electrical power to the unit.
3. Remove the heat exchanger door on the side of the unit by removing screws.
4. Move the gas control switch to the OFF position. Do not use excessive force.
5. Close the external manual gas shutoff valve.
6. Reinstall the heat exchanger door.
7. If cooling and/or air circulation is desired, turn ON the electrical power.

COOLING OPERATION

Cooling operation may be obtained as follows:

1. Place the room thermostat selector switch in the COOL position (or AUTO, if available, and if automatic changeover from cooling to heating is desired).
2. Set the room thermostat to the desired temperature.
3. If cooling system does not energize, wait five minutes. The system startup may be delayed by the short-cycle protector feature of the ignition control board. Check the manual reset devices on the rollout limit, as described in this manual.

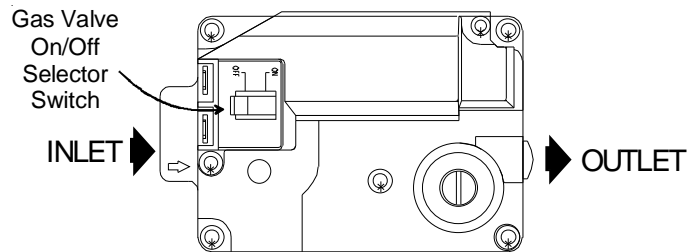

White-Rodgers Model 36F22

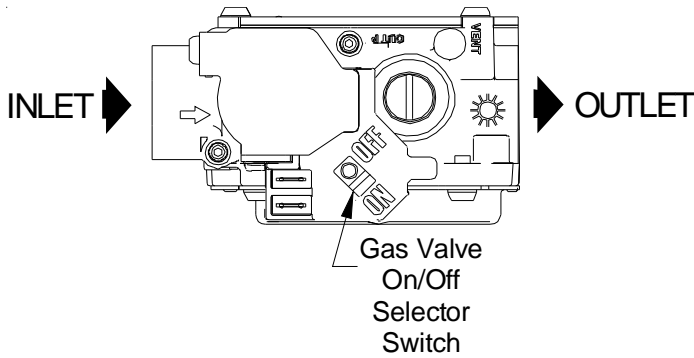

White-Rodgers Model 36G22

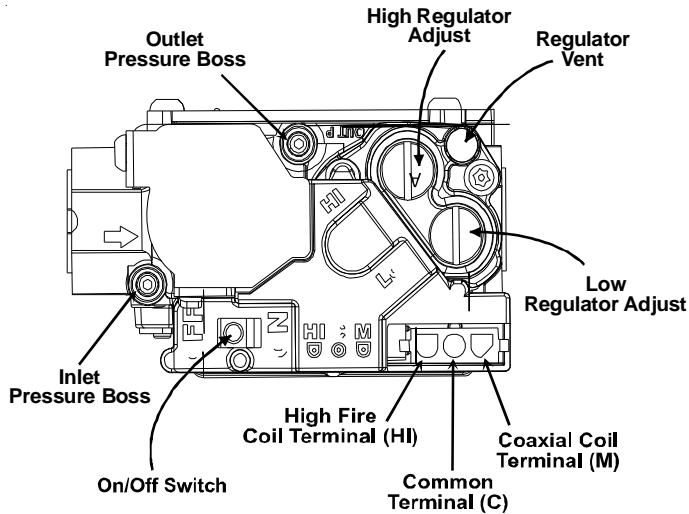

White-Rodgers Model 36G54

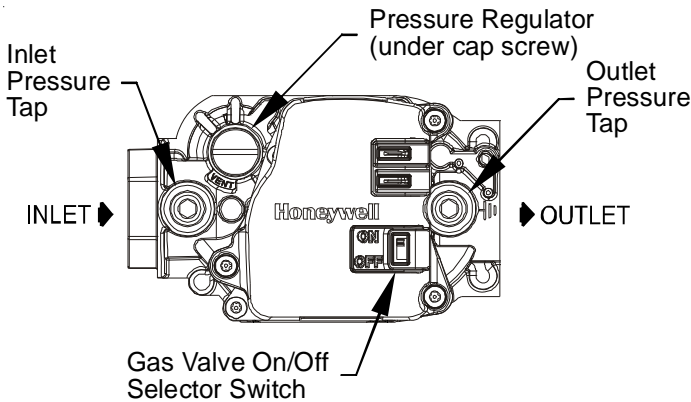

Honeywell Model VR8215 (Single-Stage)

SAFETY CIRCUITS

A number of safety circuits are employed to ensure safe and proper unit operation. These circuits serve to control any potential safety hazards and, as inputs in the monitoring and diagnosis of abnormal operation.

WARNING

IF THE SECONDARY LIMIT CONTROL SHOULD OPEN, THE REASON MUST BE DETERMINED BEFORE THE CONTROL RESETS. THE ELECTRICAL POWER MUST BE DISCONNECTED BEFORE ANY PANEL IS REMOVED OR MAINTENANCE IS PERFORMED.

SECONDARY LIMIT

The secondary limit control is located on the blower housing and monitors blower compartment temperatures. It is a normally closed (electrically), automatic reset, temperature activated sensor. This limit guards against overheating as a result of insufficient conditioned air passing over the heat exchanger. It deenergizes the gas valve if the blower fails.

NOTE: If the power to the unit is interrupted during the heating cycle, it may cause the secondary limit to trip. Once the blower compartment temperature drops below the limit reset temperature, the limit will automatically reset.

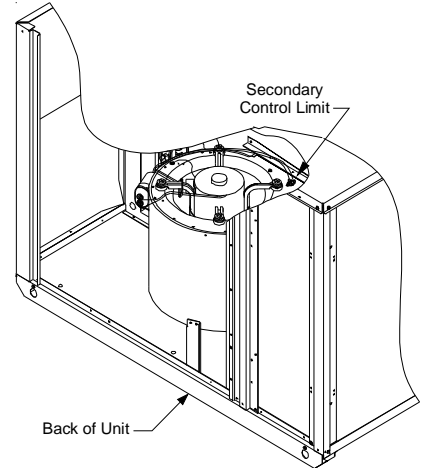

Secondary Limit Control

ROLLOUT LIMIT

WARNING

THE CAUSE OF THE ROLLOUT PROTECTION DEVICE OPENING MUST BE INVESTIGATED BY A QUALIFIED SERVICER BEFORE ANY ATTEMPT IS MADE TO RESET THE ROLLOUT PROTECTION DEVICE AND TURN THE UNIT BACK ON. THE ELECTRICAL POWER MUST BE DISCONNECTED BEFORE EITHER FRONT PANEL IS REMOVED.

The rollout limit is a normally-closed (electrically), manual-reset, temperature-activated sensor. It is mounted on the burner bracket and monitors the burner flame. If there is an improper draw of burner flames into the heat exchanger, the rollout limit will detect it and shut off gas flowing to the burners. Contact a qualified servicer to check the unit before resetting this device.

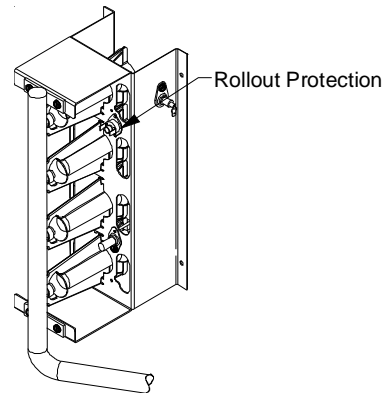

Rollout Protection on Burner Bracket

COMPRESSOR PROTECTION DEVICES

This gas/electric package unit includes components which are designed to protect the compressor against abnormal operating conditions.

**WARNING**

HIGH VOLTAGE
DISCONNECT ALL POWER BEFORE INSPECTING OR SERVICING THE UNIT. MULTIPLE POWER SOURCES MAY BE PRESENT. FAILURE TO DO SO MAY CAUSE PROPERTY DAMAGE, PERSONAL INJURY OR DEATH. SINCE ALL THE COMPRESSOR PROTECTION DEVICES RESET AUTOMATICALLY, THE CONTACTOR AND OUTDOOR FAN MAY BE ENERGIZED WHEN RESET.



NOTE: The operation of the indoor blower will not be affected by any compressor protection devices.

If, during a call for cooling, the indoor fan runs and circulates room temperature air while the compressor and outdoor fan do not operate:

1. Wait five minutes, as a protection device may be holding the compressor off.
2. Check the room thermostat to see if it is correctly set.
3. If the room thermostat is correctly set, call a qualified servicer to determine if one of the compressor protection devices has opened.

SHORT-CYCLE PROTECTOR

A short-cycle protector is built into the ignition control. Each time the compressor is off for less than 3 minutes, the short-cycle protector will delay compressor startup for up to 3 minutes. This protects the compressor from improper operation.

On Dual Fuel units (GPD/APD), the short-cycle protector will delay the compressor 5 minutes.

NOTE: These units are not designed to provide mechanical cooling at outdoor temperatures below 50°F. If low ambient cooling is needed, consult a qualified servicer.

IGNITER

The unit has an electronic ignition device which lights the burners automatically. Never try to light the burners by hand. It also has an induced draft blower to exhaust combustion products.

INDOOR AIR CIRCULATOR BLOWER

Keep the blower access door panel in place except for inspection and maintenance.

ROUTINE MAINTENANCE

If you perform maintenance on the unit yourself, remember that certain mechanical and electrical knowledge, skills and tools are required to perform unit maintenance. Personal injury or death may result if you are not properly trained. You should call your installing dealer or place of purchase if you are uncertain about your ability to perform maintenance.

**WARNING**

TO AVOID PERSONAL INJURY OR DEATH DUE TO EXPLOSION OR FIRE, THE FOLLOWING PROCEDURES MUST BE FOLLOWED EXACTLY IN SEQUENCE BEFORE INSPECTING THE UNIT:

- TURN OFF GAS BY CLOSING EXTERNAL GAS SHUTOFF VALVE TO THE UNIT.
- TURN OFF ELECTRICAL POWER BY OPENING UNIT POWER DISCONNECT.
- IF THE UNIT HAS BEEN OPERATING, WAIT 15 MINUTES FOR IT TO COOL.



ANNUAL INSPECTION

Your package unit should be inspected by a qualified installer, or service agency at least twice every year. This check should be performed before the heating and cooling seasons begin. This will ensure that adequate combustion air is being drawn and the vent system is working properly. Particular attention should be paid to the following items. Repair as necessary.

- Check physical support of the unit. Ensure it is sound without any sagging, cracks, or gaps, around the base.
- Check for obvious signs of deterioration of the unit.
- Flue Hood and Combustion Air Inlet. Check for blockage (wasp nest, etc.) and corrosion.

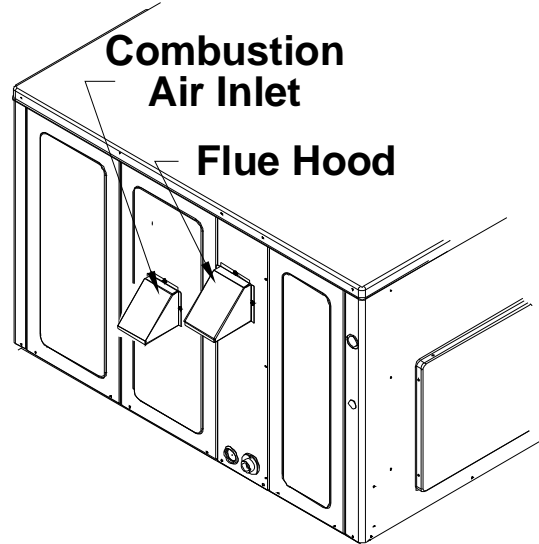

FlueHood

- Return Air Connection. Check for physical soundness and ensure that the connection is firmly sealed to the package unit casing.
- Heat exchanger. Check for corrosion and/or obstructions within the heat exchanger passageways.
- Burners. Check for proper ignition, burner flame, and flame sense.
- Wiring. Check electrical connections for tightness and/or corrosion. Check wires for damage.
- Filters. Check that filters are clean and in the proper placement in the unit or duct system.
- Louvers. Inspect air inlet louvers inside the heat exchanger compartments. Ensure the area is clean and free of dirt and debris.

REPLACING OR CLEANING FILTER

IMPORTANT NOTE: Never operate unit without a filter installed as dust and lint will build up on internal parts resulting in loss of efficiency, equipment damage and possible fire.

A return air filter is not supplied with this unit; however, there must be a means of filtering the return air. The filter(s) may be located in the return air duct(s). Consult with your installing dealer for the actual location of the return air filter(s) in your unit.

A dirty filter is the most common cause of inadequate heating or cooling performance. Filter inspection should be made at least every two months; more often if necessary because of local conditions and usage.

Dirty throwaway filters should be discarded and replaced with a new, clean filter. Dirty permanent filters should be washed with water, thoroughly dried and sprayed with a filter adhesive before being reinstalled. (Filter adhesives may be found at many hardware stores.) Permanent filters should last several years. However, should one become worn or uncleanable, it should be replaced.

When installing a new filter or reinstalling an old one, always make certain the air flow arrows on the filter point in the proper direction.

CLEAN OUTSIDE COIL (QUALIFIED SERVICER ONLY)

 WARNING
<p>TO AVOID PERSONAL INJURY OR DEATH DUE TO ELECTRICAL SHOCK, DISCONNECT THE ELECTRICAL SWITCH BEFORE CLEANING THE COIL(S).</p>

The coil with the outside air flowing over it should be inspected annually and cleaned as frequently as necessary to keep the finned areas free of leaves, grass, seeds, and debris.

CONDENSER, EVAPORATOR, AND INDUCED DRAFT MOTORS

Bearings on the air circulating blower motor, condenser motor and the combustion fan motor are permanently lubricated. No additional oiling is required.

COMPRESSOR

The compressor motor is hermetically sealed and does not require additional oiling.

SAFETY LABELS







NOTE: If safety labels are missing or illegible, contact the installing dealer.

To obtain the proper safety labels, the Model and Serial Number of the unit must be supplied.

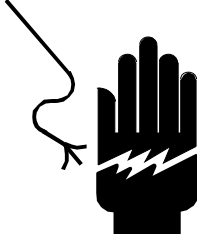
These numbers are recorded on the nameplate of the unit. For convenience, record this information here:

MODEL NUMBER: _____



SERIAL NUMBER: _____

	 WARNING 
	<p>HAZARD OF ELECTRIC SHOCK. DISCONNECT THE ELECTRIC POWER BEFORE SERVICING.</p>
	 ADVERTISSEMENT 
	<p>DECONNECTER DU CIRCUIT D'ALIMENTATION ELECTRIQUE AVANT L'ENTRETIEN.</p>
	 ADVERTENCIA 
	<p>PELIGRO DE CHOQUE ELECTRICO. DESCONECTE LA POTENCIA ELECTRICA ANTES DEL MANTENIMIENTO.</p>
	<p>B14933-152A</p>

 WARNING
<p>IF NOT INSTALLED, OPERATED AND MAINTAINED IN ACCORDANCE WITH MANUFACTURER'S INSTRUCTIONS, THIS PRODUCT COULD EXPOSE YOU TO SUBSTANCES IN FUEL OR FROM FUEL COMBUSTION WHICH CAN CAUSE DEATH OR SERIOUS ILLNESS AND WHICH ARE KNOWN TO THE STATE OF CALIFORNIA TO CAUSE CANCER, BIRTH DEFECTS OR OTHER REPRODUCTIVE HARM.</p>
<p>B14933-36</p>

 WARNING
<p>HEATING UNITS SHOULD NOT BE UTILIZED WITHOUT REASONABLE, ROUTINE, INSPECTION, MAINTENANCE AND SUPERVISION. IF THE BUILDING IN WHICH ANY SUCH DEVICE IS LOCATED WILL BE VACANT, CARE SHOULD BE TAKEN THAT SUCH DEVICE IS ROUTINELY INSPECTED, MAINTAINED AND MONITORED. IN THE EVENT THAT THE BUILDING MAY BE EXPOSED TO FREEZING TEMPERATURES AND WILL BE VACANT, ALL WATER-BEARING PIPES SHOULD BE DRAINED, THE BUILDING SHOULD BE PROPERLY WINTERIZED, AND THE WATER SOURCE CLOSED. IN THE EVENT THAT THE BUILDING MAY BE EXPOSED TO FREEZING TEMPERATURES AND WILL BE VACANT, ANY HYDRONIC COIL UNITS SHOULD BE DRAINED AS WELL AND, IN SUCH CASE, ALTERNATIVE HEAT SOURCES SHOULD BE UTILIZED.</p>
<p>B14933-206</p>

SAFETY LABELS

 <p>CARBON MONOXIDE POISONING HAZARD</p> <p>Special Warning for Installation of Furnace or Air Handling Units in Enclosed Areas such as Garages, Utility Rooms or Parking Areas</p> <p>Carbon monoxide producing devices (such as an automobile, space heater, gas water heater, etc.) should not be operated in enclosed areas such as unventilated garages, utility rooms or parking areas because of the danger of carbon monoxide (CO) poisoning resulting from the exhaust emissions. If a furnace or air handler is installed in an enclosed area such as a garage, utility room or parking area and a carbon monoxide producing device is operated therein, there must be adequate, direct outside ventilation.</p> <p>This ventilation is necessary to avoid the danger of CO poisoning which can occur if a carbon monoxide producing device continues to operate in the enclosed area. Carbon monoxide emissions can be (re)circulated throughout the structure if the furnace or air handler is operating in any mode.</p> <p>CO can cause serious illness including permanent brain damage or death. B10259-216</p>	 <p>RIESGO DE INTOXICACIÓN POR MONÓXIDO DE CARBONO</p> <p>Advertencia especial para la instalación de calentadores ó manejadoras de aire en áreas cerradas como estacionamientos ó cuartos de servicio.</p> <p>Los equipos ó aparatos que producen monóxido de carbono (ta) como automóvil, calentador de gas, calentador de agua por medio de gas, etc) no deben ser operados en áreas cerradas debido al riesgo de envenenamiento por monóxido de carbono (CO) que resulta de las emisiones de gases de combustión. Si el equipo ó aparato se opera en dichas áreas, debe existir una adecuada ventilación directa al exterior. Esta ventilación es necesaria para evitar el peligro de envenenamiento por CO, que puede ocurrir si un dispositivo que produce monóxido de carbono sigue operando en el lugar cerrado.</p> <p>Las emisiones de monóxido de carbono pueden circular a través del aparato cuando se opera en cualquier modo.</p> <p>El monóxido de carbono puede causar enfermedades severas como daño cerebral permanente ó muerte. B10259-216</p>	 <p>RISQUE D'EMPOISONNEMENT AU MONOXYDE DE CARBONE</p> <p>Advertencia especial para la instalación de calentadores ó manejadoras de aire en áreas cerradas como estacionamientos ó cuartos de servicio.</p> <p>Avertissement special au sujet de l'installation d'appareils de chauffage ou de traitement d'air dans des endroits clos, tels les garages, les locaux d'entretien et les stationnements. Evitez de mettre en marche les appareils produisant du monoxyde de carbone (tels que les automobile, les appareils de chauffage autonome, etc.) dans des endroits non ventilés tels que les d'empoisonnement au monoxyde de carbone. Si vous devez faire fonctionner ces appareils dans un endroit clos, assurez-vous qu'il y ait une ventilation directe provenant de l'exterieur.</p> <p>Cette ventilation est nécessaire pour éviter le danger d'intoxication au CO pouvant survenir si un appareil produisant du monoxyde de carbone continue de fonctionner au sein de la zone confinée.</p> <p>Les émissions de monoxyde de carbone peuvent être recirculées dans les endroits clos, si l'appareil de chauffage ou de traitement d'air sont en marche.</p> <p>Le monoxyde de carbone peut causer des maladies graves telles que des dommages permanents au cerveau et même la mort. B10259-216</p>
---	--	--

FOR ADDITIONAL INFORMATION

Most questions can be answered by your local dealer. If you have other matters that cannot be resolved locally, or you need additional information regarding other heating and cooling products offered by us - please call:

**CONSUMER INFORMATION LINE:
TOLL FREE
1-877-254-4729 (U.S. only)
email us at: customerservice@goodmanmfg.com
fax us at: (731) 856-1821
(Not a technical assistance line for dealers.)**

**Outside the U.S., call 1-713-861-2500.
(Not a technical assistance line for dealers.)
Your telephone company will bill you for the call.**

SAFETY LABELS

FOR YOUR SAFETY READ BEFORE OPERATING



WARNING



If you do not follow these instructions exactly, a fire or explosion may result causing property damage, personal injury or loss of life.

A. This appliance does not have a pilot. It is equipped with an ignition device which automatically lights the burners. Do not try to light the burners by hand.

B. BEFORE OPERATING smell around the appliance area for gas. Be sure to smell next to the floor because some gas is heavier than air and will settle on the floor.

WHAT TO DO IF YOU SMELL GAS

- Do not try to light any appliance.
- Do not touch any electric switch; do not use any telephone in your building.
- Immediately call your supplier from a neighbor's phone. Follow the gas suppliers instructions.

• If you cannot reach your gas supplier, call the fire department.

C. Use only your hand to move the gas control switch or knob. Never use tools. If the gas control switch or knob will not operate, don't try to repair it, call a qualified service technician. Force or attempted repair may result in a fire or explosion.

D. Do not use this appliance if any part has been under water. Immediately call a qualified service technician to inspect the appliance and to replace any part of the control system and any gas control which has been under water.

WARNING: Improper installation, adjustment, alteration, service or maintenance can cause injury or property damage. Refer to the user's information manual provided with this furnace. For assistance or additional information consult a qualified installer, service agency or the gas supplier.

This furnace must be installed in accordance with the manufacturers instructions and local codes. In the absence of local codes, follow the National Fuel Gas Code, ANSI Z223.1.

OPERATING INSTRUCTIONS

1. STOP! Read the safety information above on this label.
2. Set the thermostat to lowest setting.
3. Turn off all electric power to the appliance.
4. This appliance is equipped with an automatic ignition system which automatically lights the burners. Do not try to light the burners by hand.
5. Remove control access panel.
6. Move the gas control switch or knob to "OFF".

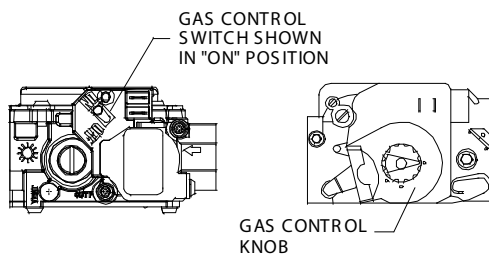

7. Wait five (5) minutes to clear out any gas. If you then smell gas, STOP! Follow "B" in the safety information above on this label. If you don't smell gas, go to the next step.
8. Move the gas control switch or knob to "ON".
9. Replace control access panel.
10. Turn on all electric power to the appliance.
11. Set the thermostat to the desired setting.
12. If the appliance will not operate, follow the instructions "To Turn Off Gas To Appliance" and call your service technician or gas supplier.

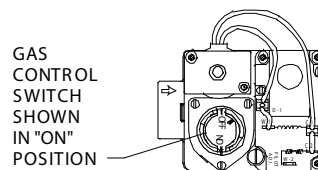

For outdoor installation only.

WARNING: If not installed, operated and maintained in accordance with the manufacturer's instructions, this product could expose you to substances in fuel combustion which can cause death or serious illness and which are known to the State of California to cause cancer, birth defects or other reproductive harm. This product contains fiberglass insulation. Fiberglass insulation contains a chemical known by the State of California to cause cancer.

TO TURN OFF GAS TO APPLIANCE

1. Set the thermostat to its lowest setting.
2. Turn off all electric power to the appliance if service is to be performed.
3. Remove control access panel.
4. Move the gas control switch or knob to "OFF". Do not force.
5. Replace control access panel.

FOR YOUR SAFETY Do not store or use gasoline or other flammable vapors and liquids in the vicinity of this or any other appliance.

B14933-239

SAFETY LABELS

FOR YOUR SAFETY READ BEFORE OPERATING



WARNING



If you do not follow these instructions exactly, a fire or explosion may result causing property damage, personal injury or loss of life.

A. This appliance does not have a pilot. It is equipped with an ignition device which automatically lights the burners. Do not try to light the burners by hand.

B. BEFORE OPERATING smell all around the appliance area for gas. Be sure to smell next to the floor because some gas is heavier than air and will settle on the floor.

WHAT TO DO IF YOU SMELL GAS

- Do not try to light any appliance.
- Do not touch any electric switch; do not use any telephone in your building.
- Immediately call your gas supplier from a neighbor's phone. Follow the gas suppliers instructions.

• If you cannot reach your gas supplier, call the fire department.

C. Use only your hand to move the gas control switch or knob. Never use tools. If the gas control switch or knob will not operate, don't try to repair it, call a qualified service technician. Force or attempted repair may result in a fire or explosion.

D. Do not use this appliance if any part has been under water. Immediately call a qualified service technician to inspect the appliance and to replace any part of the control system and any gas control which has been under water.

WARNING: Improper installation, adjustment, service or maintenance can cause injury or property damage. Refer to the user's information manual provided with this furnace. For assistance or additional information consult a qualified installer, service agency or the gas supplier.

This furnace must be installed in accordance with the manufacturers instructions and local codes. In the absence of local codes, follow the National Fuel Gas Code, ANSI Z223.1.

OPERATING INSTRUCTIONS

1. STOP! Read the safety information above on this label.
2. Set the thermostat to lowest setting.
3. Turn off all electric power to the appliance.
4. This appliance is equipped with an automatic ignition system which automatically lights the burners. Do not try to light the burners by hand.
5. Remove control access panel.
6. Move the gas control switch or knob to "OFF".

GAS CONTROL SWITCH SHOWN IN "ON" POSITION

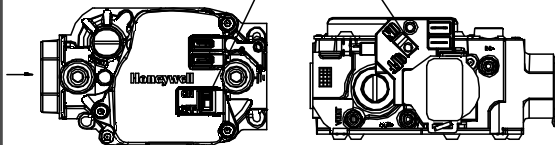

7. Wait five (5) minutes to clear out any gas. Then smell for gas, including near the floor. If you smell gas, STOP! Follow "B" in the safety information above on this label. If you don't smell gas, go to the next step.
8. Move the gas control switch or knob to "ON".
9. Replace control access panel.
10. Turn on all electric power to the appliance.
11. Set the thermostat to the desired setting.
12. If the appliance will not operate, follow the instructions "To Turn Off Gas To Appliance" and call your service technician or gas supplier.

WARNING: If not installed, operated and maintained in accordance with the manufacturer's instructions, this product could expose you to substances in fuel combustion which can cause death or serious illness and which are known to the State of California to cause cancer, birth defects or other reproductive harm. This product contains fiberglass insulation. Fiberglass insulation contains a chemical known by the State of California to cause cancer.

TO TURN OFF GAS TO APPLIANCE

1. Set the thermostat to its lowest setting.
2. Turn off all electric power to the appliance if service is to be performed.
3. Remove control access panel.
4. Move the gas control switch or knob to "OFF". Do not force.
5. Replace control access panel.

FOR YOUR SAFETY Do not store or use gasoline or other flammable vapors and liquids in the vicinity of this or any other appliance.

0140F01902-A

SAFETY LABELS

FOR YOUR SAFETY READ BEFORE OPERATING

WARNING: If you do not follow these instructions exactly, a fire or explosion may result causing property damage, personal injury or loss of life.

- A. This appliance does not have a pilot. It is equipped with an ignition device which automatically lights the burner. Do not try to light the burner by hand.
- B. **BEFORE OPERATING** smell all around the appliance area for gas. Be sure to smell next to the floor because some gas is heavier than air and will settle on the floor.
- WHAT TO DO IF YOU SMELL GAS**
- o Do not try to light any appliance.
 - o Do not touch any electric switch; do not use any phone in your building.
 - o Immediately call your gas supplier from a neighbor's phone. Follow the gas supplier's instructions.
 - o If you cannot reach your gas supplier, call the fire department.
- C. Use only your hand to push in or turn the gas control lever. Never use tools. If the lever will not push in or turn by hand, don't try to repair it, call a qualified service technician. Force or attempted repair may result in a fire or explosion.
- D. Do not use this appliance if any part has been underwater. Immediately call a qualified service technician to inspect the appliance and to replace any part of the control system and any gas control which has been underwater.

LIRE AVANT DE METTRE EN MARCHELIRE

AVERTISSEMENT: Quiconque ne respecte pas à la lettre les instructions dans le présent manuel risque de déclencher un incendie ou une explosion entraînant des dommages matériels, des lésions corporelles ou la perte de vies humaines.

- A. Cet appareil ne comporte pas de veilleuse. Il est muni d'un dispositif d'allumage qui allume automatiquement le brûleur. Ne pas tenter d'allumer le brûleur manuellement.
- B. **AVANT DE LE FAIRE FONCTIONNER,** renifler tout autour de l'appareil pour détecter une odeur de gaz. Renifler près du plancher, car certains gaz sont plus lourds que l'air et peuvent s'accumuler au niveau du sol.
- QUE FAIRE S'IL Y A UNE ODEUR DE GAZ**
- o Ne pas tenter d'allumer d'appareils.
 - o Ne toucher à aucun interrupteur; ne pas vous servir des téléphones dans le bâtiment.
 - o Appelez immédiatement votre fournisseur de gaz depuis un voisin. Suivez les instructions du fournisseur de gaz.
 - o Si vous ne pouvez rejoindre le fournisseur de gaz, appelez le service des incendies.»
- C. Ne pousser ou tourner la manette d'admission du gaz qu'à la main. Ne jamais employer d'outil à cette fin. Si la manette reste coincée, ne tenter pas de la réparer; appelez un technicien qualifié. Quiconque tente de forcer la manette ou de la réparer peut provoquer une explosion ou un incendie.»
- D. Ne pas se servir de cet appareil s'il a été plongé dans l'eau, même partiellement. Faire inspecter l'appareil par un technicien qualifié et remplacer toute partie du système de contrôle et toute commande qui ont été plongées dans l'eau.»

OPERATING INSTRUCTIONS

1. **STOP.** Read the safety information above on this label.
2. Set the thermostat to lowest setting.
3. Turn off all electric power to the appliance.
4. This appliance is equipped with an ignition device which automatically lights the burner. Do not try to light the burner by hand.
5. Push the gas control lever to "OFF" Position. Do not force.
6. Wait five (5) minutes to clear out any gas. Then smell for gas, including near the floor. If you then smell gas, **STOP.** Follow "B" in the safety information above on this label if you don't smell gas, go to next step.
7. Push gas control lever to "ON".
8. Replace access panel.
9. Turn on all electric power to the appliance.
10. Set thermostat to desired setting.
11. If the appliance will not operate, follow the instructions "To Turn Off Gas To Appliance" and call your service technician or gas company.

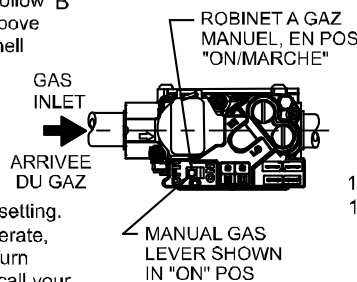

MISE EN MARCHÉ

1. **ARRÊTEZ** Lisez les instructions de sécurité dans la section supérieure de cette étiquette.
2. Régler le thermostat à la température la plus basse.
3. Couper l'alimentation électrique de l'appareil.
4. Cet appareil ménager étant doté d'un système d'allumage automatique, ne pas essayer à allumer le brûleur manuellement.
5. Pousse le levier du contrôle du gaz à "OFF/ ARRET" position.
6. Attendre cinq (5) minutes pour laisser échapper tout le gaz. Renifler tout autour de l'appareil, y compris près du plancher, pour détecter une odeur de gaz. Si c'est le cas, **ARRÊTEZ.** Passer à l'étape B des instructions de sécurité sur la portion supérieure de cette étiquette. S'il n'y a pas d'odeur de gaz, passer à l'étape suivante.
7. Pousse le levier du contrôle du gaz à "ON/MARCHE" position.
8. Remettre en place le panneau d'accès.
9. Mettre l'appareil sous tension.
10. Régler le thermostat à la température désirée.
11. Si l'appareil ne se met pas en marche, suivre les instructions intitulées "Comment couper l'admission de gaz de l'appareil" et appeler un technicien qualifié ou le fournisseur de gaz.

TO TURN OFF GAS TO APPLIANCE

1. Set the thermostat to lowest setting.
2. Turn off all electric power to the appliance if service is to be performed.
3. Push the gas control lever to "OFF" Position. Do not force.
4. Replace control access panel.

POUR COUPER L'ADMISSION DE GAZ DE L'APPAREIL

1. Régler le thermostat à la température la plus basse.
2. Couper l'alimentation électrique de l'appareil s'il faut procéder à des opérations d'entretien.
3. Pousse le levier du contrôle du gaz à "OFF/ ARRET" position. Ne pas forcer.
4. Remettre en place le panneau d'accès.

0140F00000P REV D

Goodman Manufacturing Company, L.P.
5151 San Felipe, Suite 500, Houston, TX 77056
www.goodmanmfg.com