

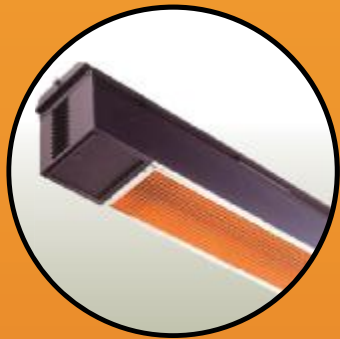

Heating Safely with Gas-Fired Infrared Heaters



Patio Heater



High Intensity
Ceramic Heater



Low Intensity
Tube Heater



Construction Heater

FROM THE INFRARED HEATER SAFETY COUNCIL

WHAT'S INSIDE

- Updated Warnings and Standards
- Added Clearances to Combustibles Information
- Revised Safety Checklist
- Venting and Gas Connections
- Participating Member Updates



High Intensity
Ceramic Heater



Low Intensity
Tube Heater



Construction
Heater



Patio Heater

What Is a Gas-Fired, Infrared Heater?

There are several types of gas-fired, infrared heaters, such as ceramic heaters, tube heaters, and patio heaters. These heaters consist of a burner in which air and gas are combined to produce a flame (combustion); heat exchanger tubing that emits heat; and reflectors that direct heat towards floors, equipment, and occupants below.

Clean, Quiet, and Efficient Heating

There are many benefits to using gas-fired, infrared heaters. Just as the sun heats the earth, infrared heaters heat people and objects directly. Warmed objects in turn create a heat sink which allows for quick heat recovery and greater comfort at lower air temperatures. The result is proven lower fuel and electricity costs.

Unlike air heaters, infrared heaters do not blow dirt and dust, but instead provide quiet, clean comfort. They are easy to install as well as to maintain; and with the many models on the market today, infrared heaters offer design flexibility to fit a variety of floor plans and building types.

Refer to the IRSC for Current, Accurate Information

The Infrared Heater Safety Council (IRSC) was created by gas-fired, infrared heating equipment manufacturers to enhance user safety through safety education of building inspectors, fire authorities, and end users.

Infrared heating technology has a long history of safety and has been widely used in a variety of commercial and industrial applications such as warehouses, manufacturing facilities, fire stations, vehicle service facilities, and aircraft hangars. As with all gas burning products, infrared heaters have installation, operation, and service procedures that must be followed to ensure safety.

Note: While this brochure covers basic concepts, it does not replace manufacturers' installation, operation, and service manuals. Read the instructions and follow them. The IRSC recommends that all installation, service, and annual inspection work be performed by a qualified person or agency.

Why Building Owners Choose Infrared Heating

- Average 30% fuel savings over conventional heating methods.
- Heating the floor level, not the ceiling, provides superior comfort.
- Flexible heater placement allows heat concentration where it is needed most.
- Infrared heaters are durable and can be easily maintained and cleaned.
- Infrared heaters do not push dirt and dust around, resulting in a quiet and clean environment.



Proper Use

Infrared heaters are designed to provide warmth and comfort for commercial, industrial, and some approved residential applications. Most infrared heaters* are not approved for:

- Residential indoor living or sleeping areas.
- Process heating, such as paint booths, grain bins, material drying.
- Hazardous (class 1 or 2) environments.

* Only applies to infrared heaters certified to standards ANSI Z83.20/CSA 2.34 [Low Intensity], ANSI Z83.19/CSA 2.35 [High Intensity], ANSI Z83.7/CSA 2.14 [Construction] or ANSI Z83.26/CSA 2.37 [Patio Heaters]

WARNING



Apply and operate infrared heaters only as allowed by the manufacturer, local fire marshal, fire inspector, and insurance agency, and in accordance with national, state, local, or provincial codes.

Combustible items may include:

- Wood
- Paper
- Fabric
- Chemicals
- Paint
- Rubber
- Plastic
- Parked Vehicles
- Gasoline
- Storage Racks

Additional clearance considerations may include:

- Sprinkler Heads
- PVC Conduit
- Overhead Doors
- Vehicle Lifts
- Hoses
- Cranes
- Partitions
- Hoists

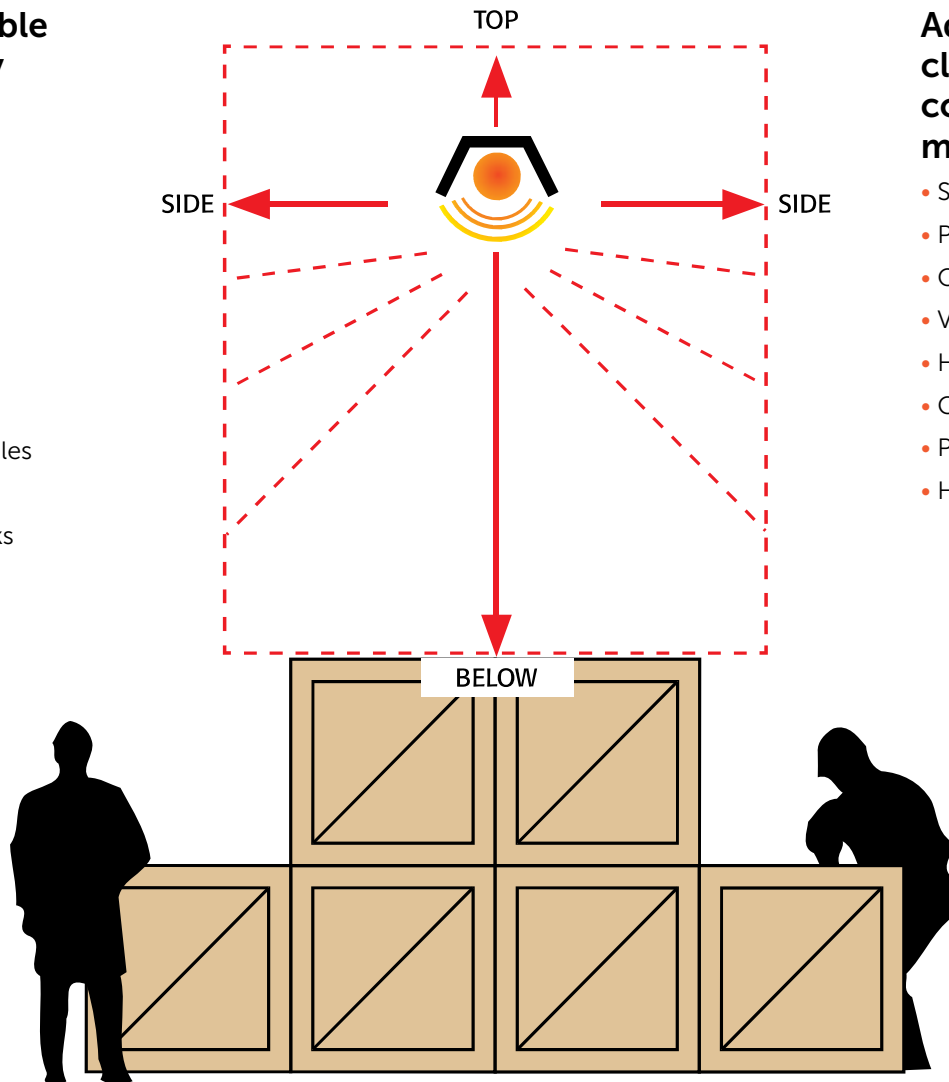

Clearances to Combustibles

Responsibility of the Installers and Users

Ensure that building materials with a low heat tolerance are protected to prevent degradation.

"...in locations used for storage of combustible materials, signs shall be posted to specify the maximum permissible stacking height to maintain the required clearances from the heater to the combustibles."

This is quoted from the Standard for Gas-Fired Low-Intensity Infrared Heaters (ANSI Z83.20/CSA 2.34) and the National Fuel Gas Code (ANSI Z223.1/NFPA 54).

ANSI Z83.20/CSA 2.34 further states "... and that such signs must either be posted adjacent to the heater thermostat or in the absence of such thermostat in a conspicuous location."

Clearances to Combustibles Safety Issues

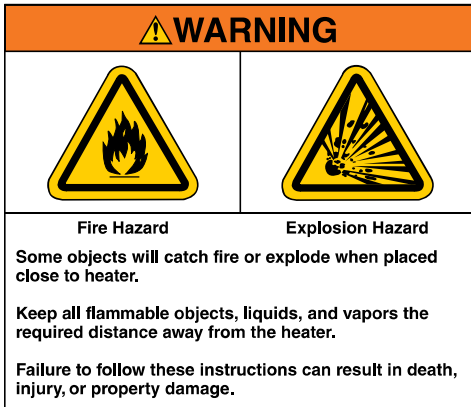

Clearances are the required minimum distances that combustible objects can be placed from the heater to prevent fire hazards. Combustibles are materials which may catch on fire and include common items such as wood, paper, rubber, and fabric. Clearances to combustibles must be maintained at all times to ensure safety.

Even if equipment is installed with the proper clearances to combustibles, some materials may be present that have lower heat tolerances and may be subjected to degradation.

All infrared heaters shall have the clearances to combustibles prominently displayed on the product, as well as in the installation, operation and service manual.

Read, understand, and follow the safety guidelines below:

- Keep gasoline or other combustible materials including flammable objects, liquids, dust, or vapors away from the heater or any other appliance.
- Maintain clearances from heat sensitive material, equipment, and workstations.
- Maintain clearances from heat sensing devices, such as sprinkler systems, and make sure these devices are not overheated.

- Maintain clearances from vehicles parked below the heater.
- Maintain clearances from swinging and overhead doors, overhead cranes, vehicle lifts, partitions, storage racks, hoists, building construction, etc.
- Hang heater in accordance with manufacturer's suspension requirements.
- Do not run gas pipe or conduit in the area of exhaust discharge of flue products or in the clearance zone.

When Building Ownership Changes

It is imperative that current and future building owners are well informed regarding the infrared heating system in their building. If the building is sold to a new owner, it is the responsibility of the seller to transfer all documentation of the heating system, including the installation, operation, and service manual to the new owner. Placards should be properly placed and/or relocated. Contact the manufacturers for additional copies of the above mentioned manuals.

Change to Building Construction and/or Heating System

Special consideration is required if:

- Building has been remodeled or renovated since the last inspection.
- Additional heaters or racking system(s) have been added.
- Equipment has not been operated for an extended period of time.
- Usage of the building has changed.
- User has questions or concerns about the operation of the equipment.

Proper Gas Connection

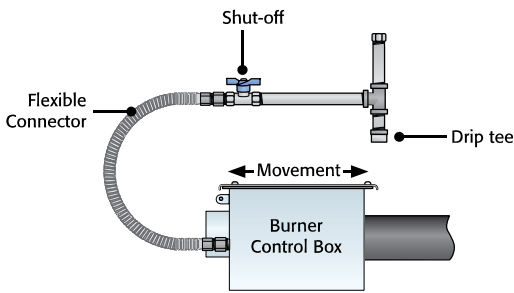

Connect heater to gas supply using the proper equipment connector. In the United States, use a flexible connector in accordance with NFPA 54/ANSI Z223.1 National Fuel Gas Code. In Canada, use a Type 1 rubber gas connector in accordance with CSA 2.34. Consult manual for instructions on pressure, expansion and other safety requirements, including local codes.

Improper Gas Connection

Do not directly connect gas supply line to heater inlet. Do not use copper piping to connect unit to the gas supply.

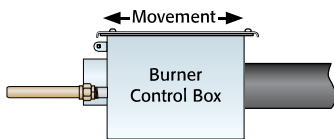



Failure to properly connect the gas supply to the unit may result in leaks, improper heater operation and possible system failure, including explosion or fire.

Proper Gas Connection

⚠ WARNING	
	
Fire Hazard	Explosion Hazard
Tighten gas connector fittings to connect gas supply.	
Gas connector moves during normal operation.	
Failure to follow these instructions can result in death, injury, or property damage.	

When connecting an infrared heater to the supply line, allowances for heater expansion are required. A flexible gas connector of approved type must be used. The gas piping system shall not bear any weight of any appliance. See NFPA 54/ANSI Z223.1 National Fuel Gas Code or CAN/CSA-B149.1 Natural Gas and Propane Installation Code, latest revision.

Gas Conversion

⚠ WARNING	
	
Carbon Monoxide Hazard	Fire Hazard
Install heater with proper ventilation per installation instructions.	
Failure to follow these instructions can result in death, injury, or property damage.	

Gas conversions must be done by a qualified person or agency following the manufacturer's conversion instructions. Contact the manufacturer for proper instructions and parts.

Proper Ventilation

Heaters must be vented per all applicable codes. See NFPA54/ANSI Z223.1 National Fuel Gas Code or CAN/CSA-B149.1 Natural Gas and Propane Installation Code, latest revision. Refer to the heater vent category on the rating plate as per ANSI Z83.20/CSA 2.34, latest revision. Use only approved vent terminations and piping. For specific ventilation requirements, reference the manufacturer's installation, operation and service manuals.

Where unvented infrared heaters are used, natural or mechanical means shall be provided to supply and exhaust air at the following rate, as applicable: at least 4 CFM per 1,000 BTU/h of input for heaters installed in the U.S. and at least 3 CFM per 1,000 BTH/h of input for heaters installed in Canada.

Rooftop Venting Requirements

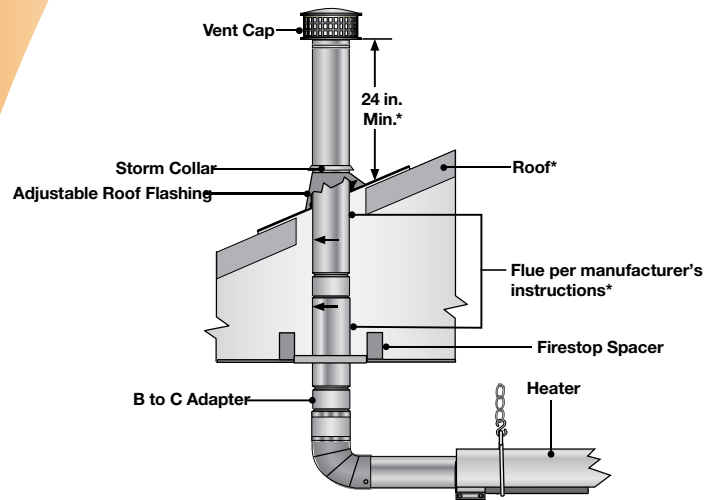

* Consult the NFPA 54/ANSI Z223.1 or CAN/CSA-B149.1 Gas Vent Termination criteria if roof pitch exceeds 9:12 and refer to manufacturer's installation instructions for vent size and length.

Carefully Follow All Ventilation Instructions!

- ☑ Provide proper fire guarding (thimbles, flashing, etc.) when venting through a combustible wall.
- ☑ Provide mechanical or natural ventilation when operating unvented.
- ☑ Provide fresh air for combustion when operating in harsh environments.
- ☑ Use a single control when common venting.
- ☑ Provide adequate separation from heater exhaust to air intake.
- ☑ Verify vent lines(s) are free of obstructions and debris.
- ☑ Use an attic insulation shield where applicable and ensure venting is free and clear of flammable objects, obstructions, and debris.

Consult manual for specific installation guidelines as each application may vary.

Sidewall Venting Requirements

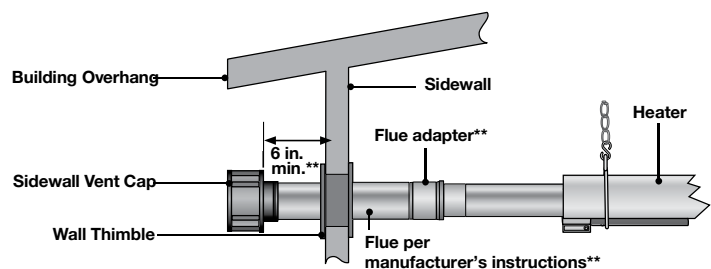

** Refer to manufacturer's installation instructions for vent type, size, and length.

Safety Inspection Checklist

For optimum performance and safety, the IRSC recommends that all installation, service, and annual inspection be done by a qualified person or agency. This is not a comprehensive list. For a complete checklist, reference the installation, operation, and service manual.

Make sure that:

- ✓ Clearances to combustibles warning signs are posted as indicated on page 4.
- ✓ The manufacturer's installation, operation, and service manual is legible. Keep manual in a clean, dry place. Contact the manufacturer for replacement labels or manuals.
- ✓ All warning labels are attached and legible.
- ✓ The area around the heater is free of combustibles.
- ✓ Reflector is in good condition and free of dust and debris. Clean outside surface with a damp cloth, if needed. Reflector must be properly resting on mounting brackets and not the tube itself.
- ✓ Vent pipe and outside air inlet are free of dirt, obstructions, cracks, gaps in the sealed areas or corrosion. Look for bird or insect nests. Remove any carbon deposits.
- ✓ Tubes are connected and suspended securely. There should be no holes, cracks or distortion on any part of the tube, especially the top.
- ✓ Gas line has no gas leaks. Check gas connection; See Proper Gas Connection in this brochure and refer to the manufacturer's installation, operation, and service manual.
- ✓ Combustion chamber and burner observation windows are clean and free of cracks or holes.
- ✓ Blower scroll wheel and motor are clean.
- ✓ Burner and orifice are clean.
- ✓ Igniter and electrode are not cracked, broken, eroded, or showing signs of wear. Replace as needed.
- ✓ Thermostats, sensors, and control devices have no exposed wire nor damage to the device or its wiring. Verify that clearance to combustible placards are posted and in accordance with manufacturer's requirements.
- ✓ Suspension of the heater is secure and in accordance with manufacturer's requirements. Look for signs of wear on the chain or ceiling.
- ✓ Pump and blower inlets and outlets are free of blockage or soot.
- ✓ Ceramic tiles in burner assembly are not operating in a flashback condition (burning behind grids).
- ✓ Ceramic tiles are not cracked. Ceramic burner assembly gaskets must be in place. Do not clean with high pressure air.
- ✓ Use an attic insulation shield where applicable and ensure venting is free and clear of flammable objects, obstructions, and debris.

Applicable Standards and Codes

Installation must comply with national and local codes and requirements of the local gas company.

Gas Codes

United States: Refer to National Fuel Gas Code, ANSI Z223.1 – latest revision (same as NFPA 54). Canada: Refer to CAN/CSA-B149.1 Natural Gas and Propane Installation Code.

Aircraft Hangars

United States: Refer to Standard for Aircraft Hangars, ANSI/NFPA 409 – latest revision. Canada: Refer to CAN/CSA-B149.1 Natural Gas and Propane Installation Code.

Public Garages

United States: Standard for Parking Structures NFPA 88A – latest revision or the Code for Motor Fuel Dispensing Facilities and Repair Garages, NFPA 30A – latest revision. Canada: Refer to CAN/CSA-B149.1 Natural Gas and Propane Installation Code.

Electrical

United States: Refer to National Electrical Code®, ANSI/NFPA 70 – latest revision. Canada: Refer to Canadian Electrical Code, CSA C22.1 Part 1 – latest revision.

Venting

The venting must be installed in accordance with the unit's installation, operation and service manual and the following codes. United States: Refer to NFPA 54/ANSI Z223.1 – latest revision, National Fuel Gas Code. Canada: Refer to CAN/CSA-B149.1 Natural Gas and Propane Installation Code.

Additional Considerations

Signage Requirements

In locations used for storing combustible materials, signs must be posted to specify the maximum permissible stacking height to maintain the required clearances from the heater to the combustibles.

Signs must be posted adjacent to the heater thermostat. In the absence of a thermostat, signs must be posted in a conspicuous location.

Location of Equipment

Infrared heaters must be installed by a qualified person or agency per applicable codes and the manufacturer's installation, operation, and service manuals. Installers are also responsible for the following:

- Installing the heater in accordance with the clearances to combustibles.
- Providing access for servicing.
- Providing a copy of the manufacturer's installation, operation, and service manual to the owner.
- Ensuring adequate air circulation around the heater.
- Ensuring that the heater is placed in an approved application.

Type of Fuel

The type of gas appearing on the heater's nameplate must be the type of gas used.



Patio Heater



High Intensity Ceramic Heater



Low Intensity Tube Heater



Construction Heater

Infrared Heater Types

Patio Heaters:

Sometimes referred to as suspended, radiant, mushroom style, free standing, or decorative patio heaters.

- Ceramic or stainless steel radiant emitters.
- Designed to heat a concentrated outdoor area.
- Permanent or portable products that may be deck mounted or suspended.

High Intensity Ceramic Heaters:

Sometimes referred to as box heaters, unvented heaters, spot heaters, luminous heaters, radiant heaters, or plaque heaters.

- Combustion takes place on a ceramic tile surface with surface temperatures of approximately 1800°F. Higher temperatures (hence, "high-intensity") result in higher clearances to combustibles.
- Direct fired operation releases products of combustion into a properly ventilated heated space.
- Often used in high bay or high air change applications.

Low Intensity Tube Heaters:

Sometimes referred to as positive/negative pressure tube heaters, tube heaters, radiant heaters, stick heaters, tube brooders, or pipe heaters.

- Hot exhaust gases travel through the inside of the tube resulting in tube surface temperatures of approximately 1100°F (hence "low-intensity").
- Can be vented and commonly have the capability to use fresh air for combustion.
- The most popular choice for total building heat.

Construction Heaters:

Sometimes referred to as salamanders, spot heaters, portable construction heaters, or tank top heaters.

- Heat turns a ceramic or stainless steel emitter red hot.
- Used in spot heat applications and/or as warm up stations.
- While commonly used in outdoor applications, units may also be used in industrial applications or temporarily used inside buildings under construction or repair. At no time shall construction heaters be used in residential applications.



Calcana

5507 6th Street SE Calgary, Alberta T2H 1L6
30201 County Rd. 49, Loxley, AL 36551
+1 800-778-6729
www.calcana.com



Detroit Radiant Products Co.

21400 Hoover
Warren, MI 48089
+1 800-222-1100
www.reverberray.com



SPACE-RAY



Gas-Fired Products, Inc.

P.O. Box 36485 (28236)
305 Doggett Street (28203)
Charlotte, NC 28236
+1 704-372-3485
www.gasfiredproducts.com



Infrared Dynamics, Inc.

3830 Prospect Avenue
Yorba Linda, CA 92886
+1 888-317-5255
www.infradyne.com



Modine Manufacturing Company

Building HVAC Systems
1500 DeKoven Ave.
Racine, WI 53403
+1 800-828-HEAT (4328)
www.modinehvac.com



Roberts-Gordon, LLC

1250 William Street, P.O. Box 44
Buffalo, New York 14240
+1 800-828-7450
www.robertsgordon.com



Schwank North America

2 Schwank Way
Waynesboro, GA 30830
5285 Bradco Blvd
Mississauga, ON L4W 2A6
+1 877-446-3727
www.schwankgroup.com



Solaronics

3720 Lapeer Rd.
Auburn Hills, MI 48326
+1 800-223-5335
www.solaronicsusa.com



**SUPERIOR
RADIANT PRODUCTS**

Superior Radiant Products

563 Barton Street, Stoney Creek, ON L8E 5S1
315 N Madison Street, Fortville, IN 46040
+1 800-527-HEAT (4328)
www.superiorradiant.com



©2018 Infrared Heater Safety Council

This brochure is issued by the Infrared Heater Safety Council and does not constitute a warranty or guaranty from any of the manufacturers listed, nor are such manufacturers responsible for the contents of this brochure. For product information on specific products, you should contact the specific manufacturer whose documentation governs each respective manufacturer's product.



Infrared Heater Safety Council
2311 Wilson Boulevard, Suite 400,
Arlington, VA 22201
irsafetycouncil.org

Nonprofit Org.
U.S. Postage
PAID
Dulles, VA
Permit No. 3

Are you using infrared heaters safely?



©2018 Infrared Heater Safety Council

For Industry Professionals, Design Engineers, Safety Inspectors,
Fire Marshals, Building Owners, and the Insurance Industry:

Heating safely with gas-fired infrared heaters

From The Infrared Heater Safety Council

irsafetycouncil.org

