



Laboratory Airflow Monitors & Controls **TYPE C STANDARD & NIGHT SETBACK LED & DIGITAL - VAV SYSTEMS**

Specifications and Owner's Manual



PLASTEC® VENTILATION, INC.

2216 60th Drive East • Bradenton, Florida 34203
(941) 751-7596 • Fax (941) 751-7598 • www.plastecvent.net

Laboratory Airflow Monitors & Controls

TYPE C STANDARD & NIGHT SETBACK

LED & DIGITAL - VAV SYSTEM

General Description

BENEFITS

- Safety: air flow is maintained at required speed at all sash heights
- Energy savings: only the lowest required amount of air is exhausted therefore reducing energy bill
- User comfort: Low air speeds ensure comfortable noise level
- Ease of installation and maintenance
- Stable and accurate analogical sensor reading
- Attractive design: available in choice of LED or digital display

RANGE

Versions:

- **C LED:** Monitors and controls air speed, LED lights
- **C DIGITAL:** Monitors and controls air speed, digital read out in meter per second or feet per minute

FEATURES

- Audio and visual alarm
- 0 to 10V or 4-20mA VAV system to link to inverter
- 3 Pushbuttons: Fan On/Off, Light On/Off, Mute
- Automatic pre-purge with inverter
- 30s purge following fan switch off
- Alarm disabled when fan switch off
- Sash High indicator
- Auxiliary contact for fan make up, etc.

OPTIONS

- **Surface Box Mounting:** Plastic enclosure to mount the face plate and to avoid profile cutting the service panel.
- **Alarm Relay:** A remote alarm can be triggered from a relay on the controller pcb.
- **Battery Back Up:** Red LED alarm is still functional up to 12 hours when unit loses power.
- **Custom Resin Stickers:** Customizable resin stickers with logo, address, etc.

COLORS

Plastic fascia is available in:
- White (Standard)



INTERNATIONAL STANDARDS COMPLIANCE

In accordance with:

- European laboratory standard EN 14175-2
- Electromagnetic standards EN 61326 : 1997/A1 : 1998/A2 : 2001/A3 : 2003 (Test report RC-05-42060-1) US FCC Part 15 Class B edition 2005 (Test report RC-05-42060-2-A)
- European RoHS directive governing disposal and recycling of electronics
- French laboratory standard XPX 15203 of Sept. 1996
- CE

COMPONENTS

- **Circuit Board:** Panel mounted circuit board to be installed vertically or horizontally onto fume cupboard with 2x Ø 2.8 mm / 0.11" screws. IP55 protection ensured by "O" ring seal. Face plate to be supplied with chemical resistant plastic sticker (horizontal or vertical) with control/push buttons on fascia. Surface box mounting optional.
- **Numerical and Antistatic Sensor:** To be installed inside fume hood. Sensor measures air speed variations inside fume hood. Supplied with a 3.5 m / 11.48' (5 m optional) shielded cable with pin connections onto controller circuit board.
- **Power Supply:** 115 VAC to 12 VDC power transformer directly into controller circuit board. Comes with a wall plug and cord. Adaptor may be required to fit local power socket.



PACKING

- Supplied in cardboard box which includes controller circuit board, face plate, sensor and power transformer. Surface box mounting optional.

Laboratory Airflow Monitors & Controls

TYPE C STANDARD & NIGHT SETBACK

LED & DIGITAL - VAV SYSTEM

Operating Principle

When the fume extraction fan is running, it causes negative pressure inside the fume cupboard. If the sash is lowered, the negative pressure become more intense causing air to be drawn through the sash opening at an increased velocity. Conversely, if the sash is raised the negative pressure becomes less intense and air velocity reduces.

If an opening is made in the wall of the fume cupboard, air will enter it at a velocity determined by the same negative pressure that is drawing air into the sash opening. By sensing the air velocity through an opening, we can determine its level at the sash opening.

PLASTEC® AirControl Type C exploits this by the placing of a numerical sensor, or thermal anemometer into a hole in the cupboard and sending the air velocity measurement obtained to a display on the fascia panel. Based on air velocity measured, Plastec® AirControl C will send a signal to an inverter to either increase or decrease fan speed.

The air velocity level is displayed on the fascia either by LED illumination or digital read-out. An audible alarm will also sound if the air velocity is too low.

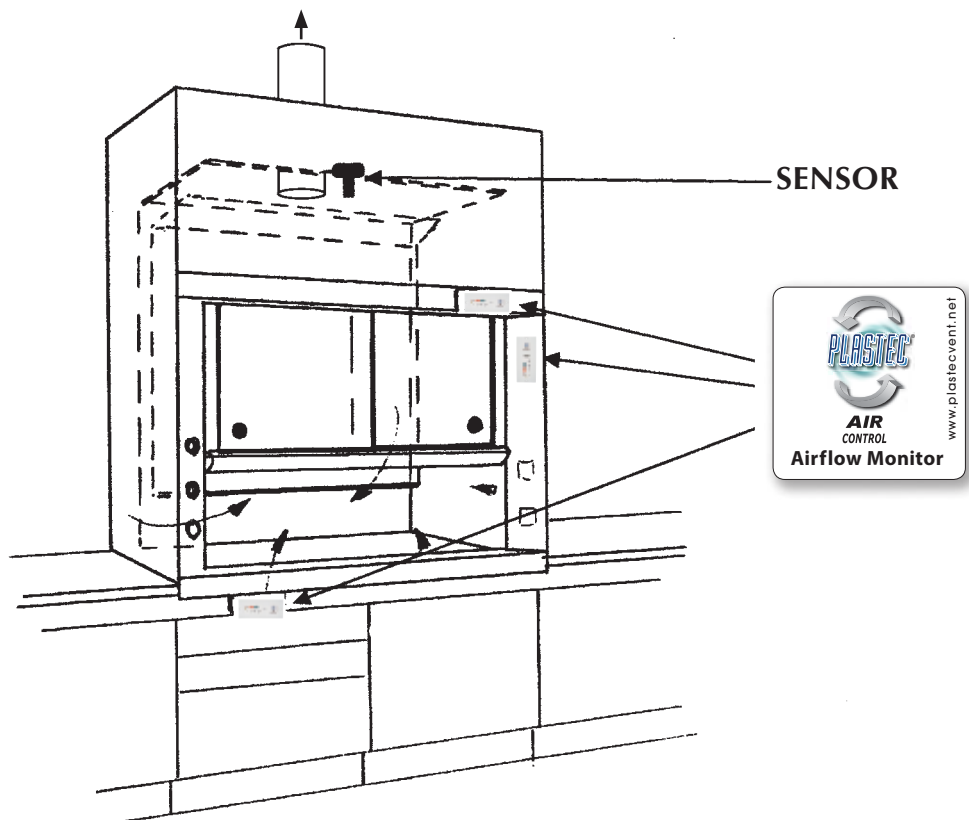

Laboratory Airflow Monitors & Controls

TYPE C STANDARD

LED & DIGITAL - VAV SYSTEM

Schematic AirControl C LED & Digital Inverter System

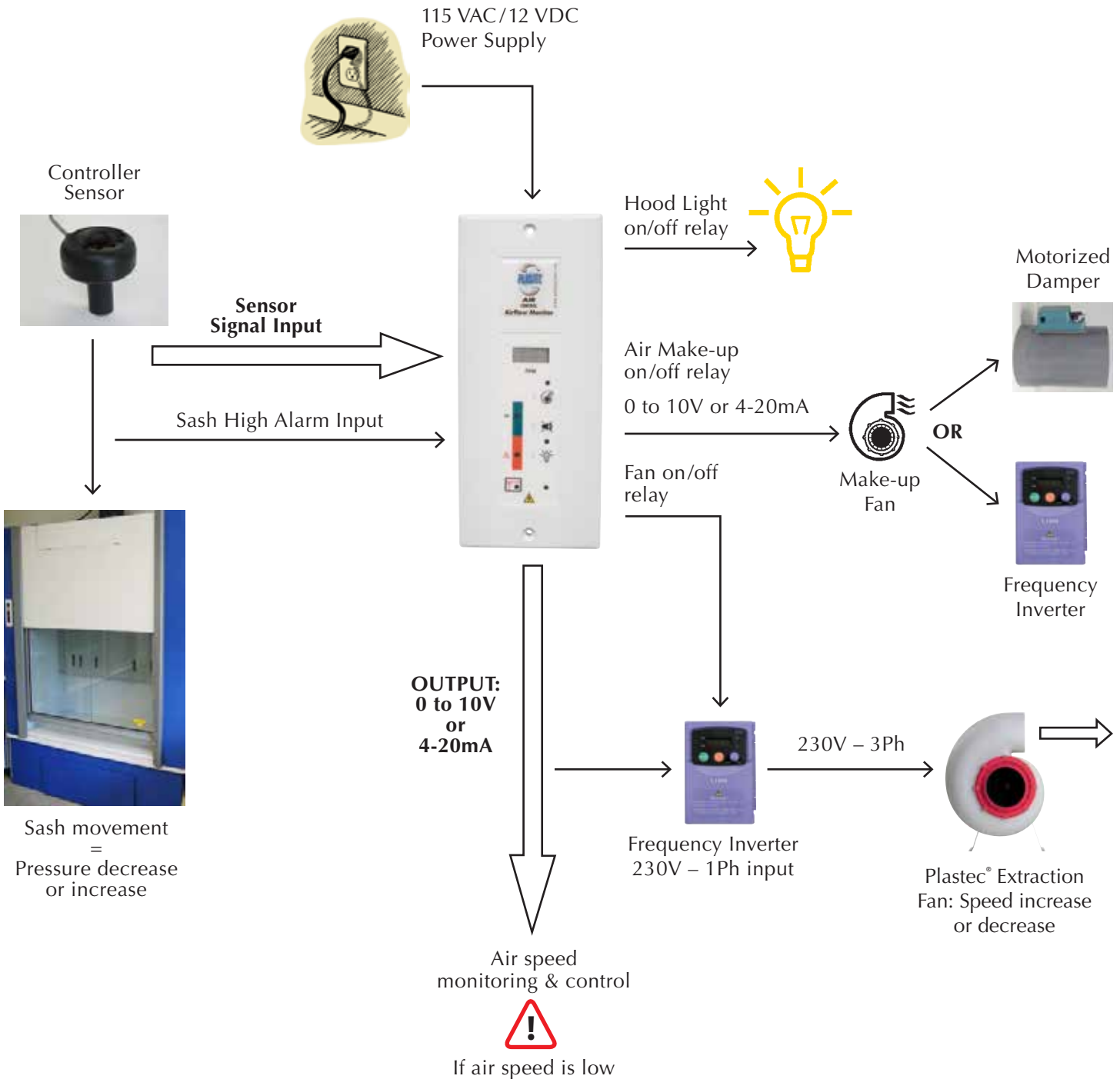

Laboratory Airflow Monitors & Controls

TYPE C NIGHT SETBACK

LED & DIGITAL - VAV SYSTEM

Schematic AirControl C Night Setback

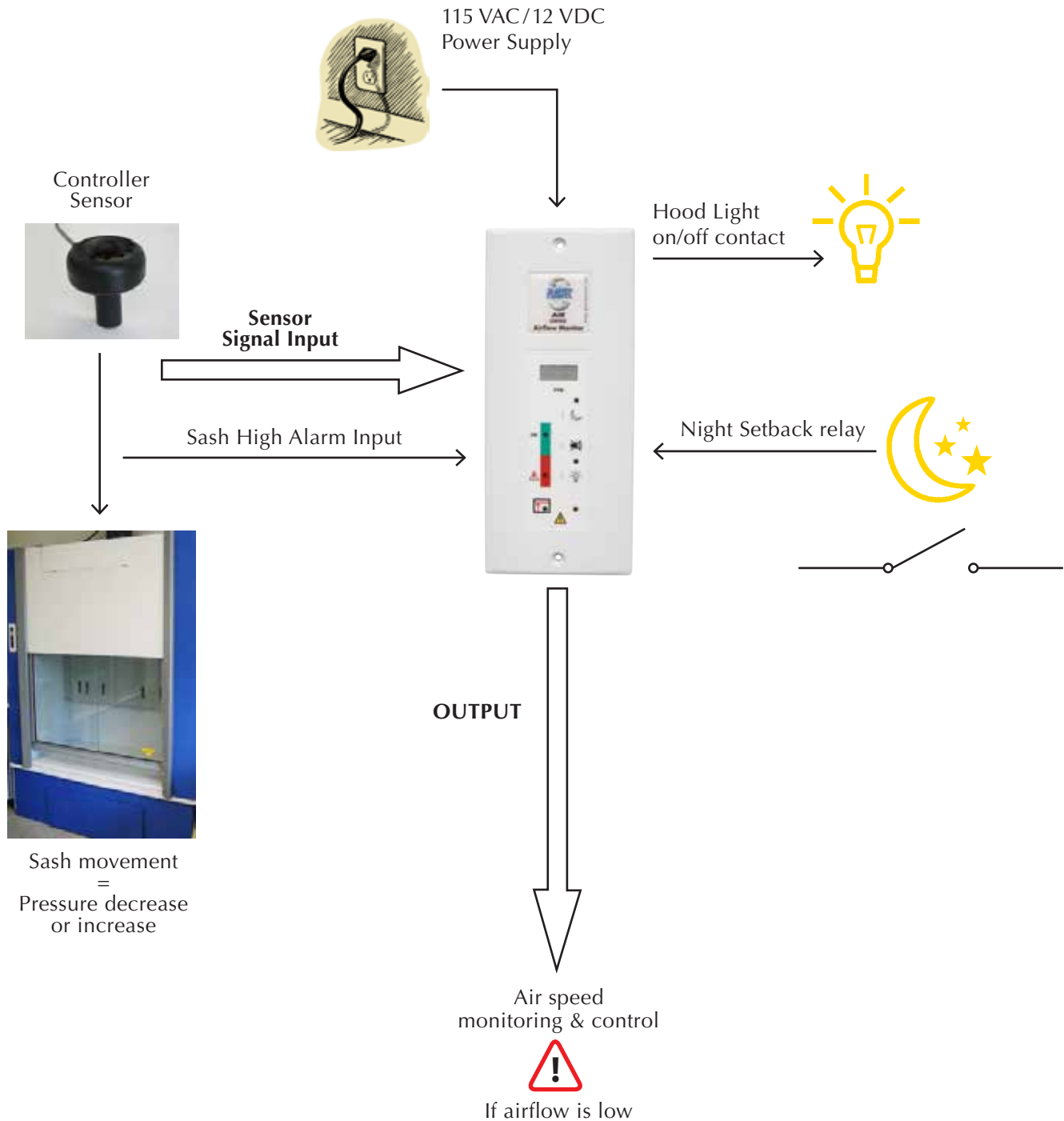









Laboratory Airflow Monitors & Controls

TYPE C STANDARD

LED & DIGITAL - VAV SYSTEM

Specifications









	AirControl C LED	AirControl C Digital
		
Part Number	819703	819704
Display – Visual	1 green LED for normal air speed 1 red LED flashing for alarm No digital display	1 green LED for normal air speed "HI" for high air speed displayed 1 red LED flashing for alarm 3 digit display with velocity reading
Units	N/A	meter per second (m/s) / FPM
Display Range	N/A	0 - 2.00 m/s / 0 - 400 FPM
Alarm Setpoint	Standard: below 0.39m/s / 78 FPM	Standard: below 0.39m/s / 78 FPM
Alarm Delay	Selectable: 15s or 30s	Selectable: 15s or 30s
Analog Output	0 - 10V or 4 - 20mA	0 - 10V or 4 - 20mA
Alarm Indication	1 red LED flashing & audible buzzer	1 red LED flashing & audible buzzer
Alarm Mute		
Light On/Off		
Fan On/Off		
Alarm Relay	Yes, optional	Yes, optional
Battery Back Up	Yes, optional	Yes, optional
Sash High Input	Audible and orange flashing LED indicate sash position switch has been tripped	Audible and orange flashing LED indicate sash position switch has been tripped
Mounting	Flush or surface box (option)	Flush or surface box (option)
Calibration	Factory pre-calibrated @ 0.5m/s / 100 FPM Recalibration possible	Factory pre-calibrated @ 0.5m/s / 100 FPM Recalibration possible
Power Requirement	12VDC (power supply included)	12VDC (power supply included)
Orientation	Vertical/Horizontal	Vertical
Monitor Dimensions (metric)	Front fascia: 210L x 90W x 10D mm Surface box: 205L x 85W x 14D mm	Front fascia: 210L x 90W x 10D mm Surface box: 205L x 85W x 14D mm
Monitor Dimensions (U.S.)	Front fascia: 8.27"L x 3.54"W x 0.39"D Surface box: 8.07"L x 3.35"W x 0.55"D	Front fascia: 8.27"L x 3.54"W x 0.39"D Surface box: 8.07"L x 3.35"W x 0.55"D

Laboratory Airflow Monitors & Controls

TYPE C NIGHT SETBACK

LED & DIGITAL - VAV SYSTEM

Specifications

	AirControl C LED	AirControl C Digital
		
Part Number	819703	819704
Display – Visual	1 green LED for normal air speed 1 red LED flashing for alarm No digital display	1 green LED for normal air speed 1 red LED flashing for alarm 3 digit display with velocity reading
Units	N/A	meter per second (m/s) / FPM
Display Range	N/A	0 - 2.00 m/s / 0 - 400 FPM
Alarm Setpoint	Standard: below 0.39m/s / 78 FPM	Standard: below 0.39m/s / 78 FPM
Alarm Delay	Selectable: 15s or 30s	Selectable: 15s or 30s
Analog Output	0-10V	0-10V
Alarm Indication	1 red LED flashing & audible buzzer	1 red LED flashing & audible buzzer
Alarm Mute		
Light On/Off		
Night Setback On/Off		
Alarm Relay	Yes, optional	Yes, optional
Battery Back Up	Yes, optional	Yes, optional
Sash High Input	Audible and orange flashing LED indicate sash position switch has been tripped	Audible and orange flashing LED indicate sash position switch has been tripped
Mounting	Flush or surface box (option)	Flush or surface box (option)
Calibration	Factory pre-calibrated @ 0.5m/s / 100 FPM Recalibration possible	Factory pre-calibrated @ 0.5m/s / 100 FPM Recalibration possible
Power Requirement	12 VDC (power supply included)	12 VDC (power supply included)
Orientation	Vertical/Horizontal	Vertical
Monitor Dimensions (metric)	Front fascia: 210L x 75W x 10D mm Surface box: 210L x 85W x 25D mm	Front fascia: 210L x 75W x 10D mm Surface box: 210L x 85W x 25D mm
Monitor Dimensions (U.S.)	Front fascia: 8.27"L x 2.95"W x 0.39"D Surface box: 8.27"L x 3.35"W x 0.99"D	Front fascia: 8.27"L x 2.95"W x 0.39"D Surface box: 8.27"L x 3.35"W x 0.99"D

Laboratory Airflow Monitors & Controls

TYPE C STANDARD & NIGHT SETBACK

LED & DIGITAL - VAV SYSTEM

Specifications

MONITOR & MOUNTING BOX

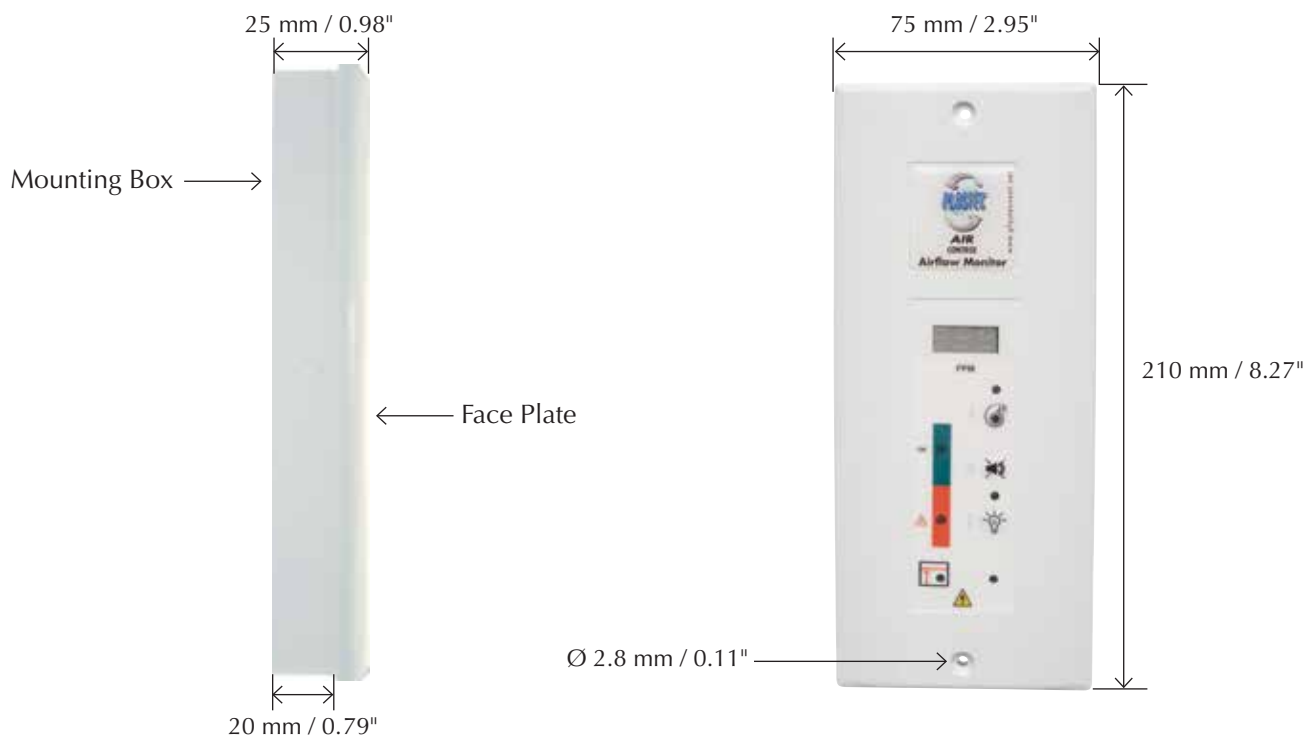

PANEL CUTOUT DIMENSION

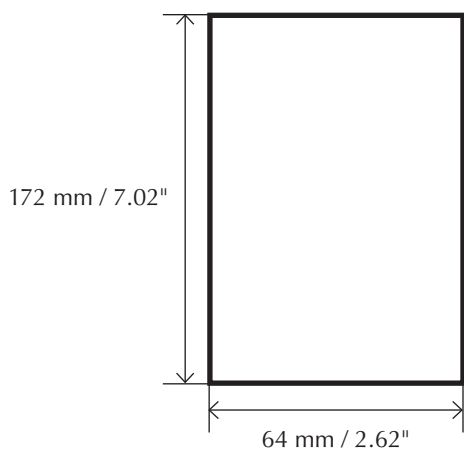

SENSOR

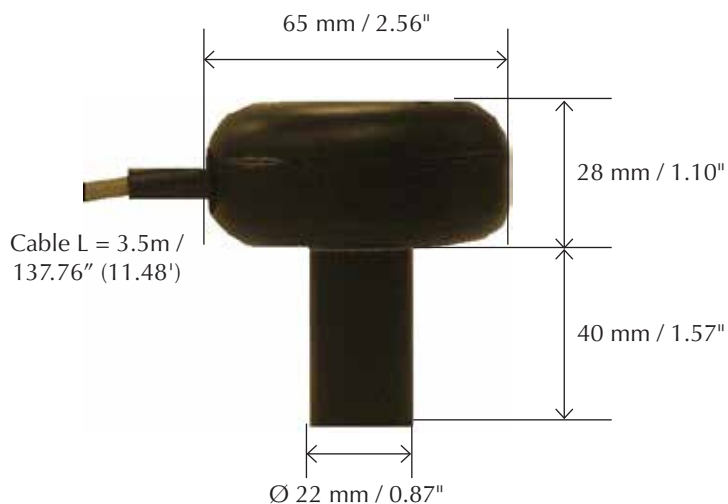

NOTE: All dimensions in mm/inches

Laboratory Airflow Monitors & Controls

TYPE C STANDARD

LED & DIGITAL - VAV SYSTEM

Overall View

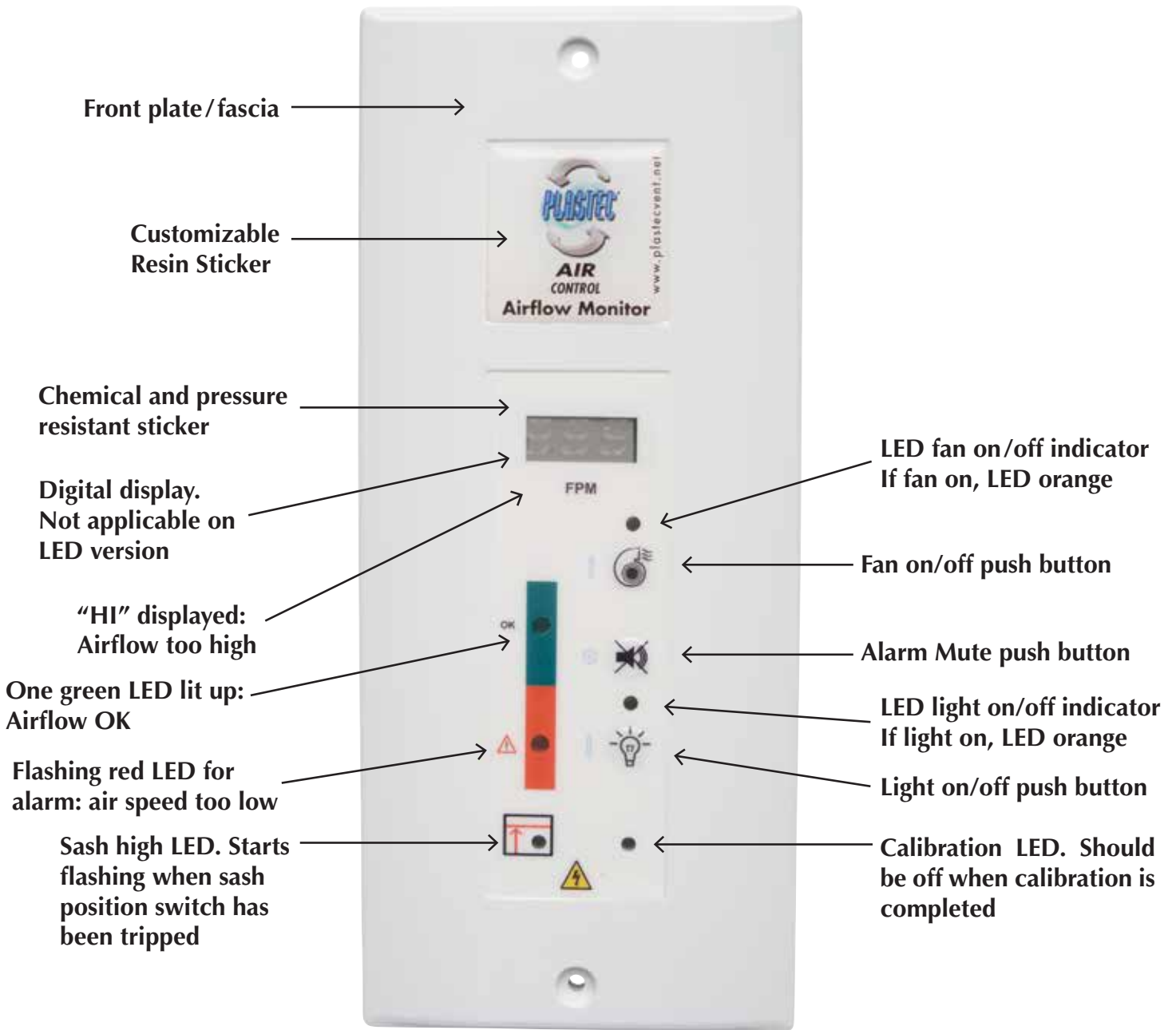

Laboratory Airflow Monitors & Controls

TYPE C NIGHT SETBACK

LED & DIGITAL - VAV SYSTEM

Overall View

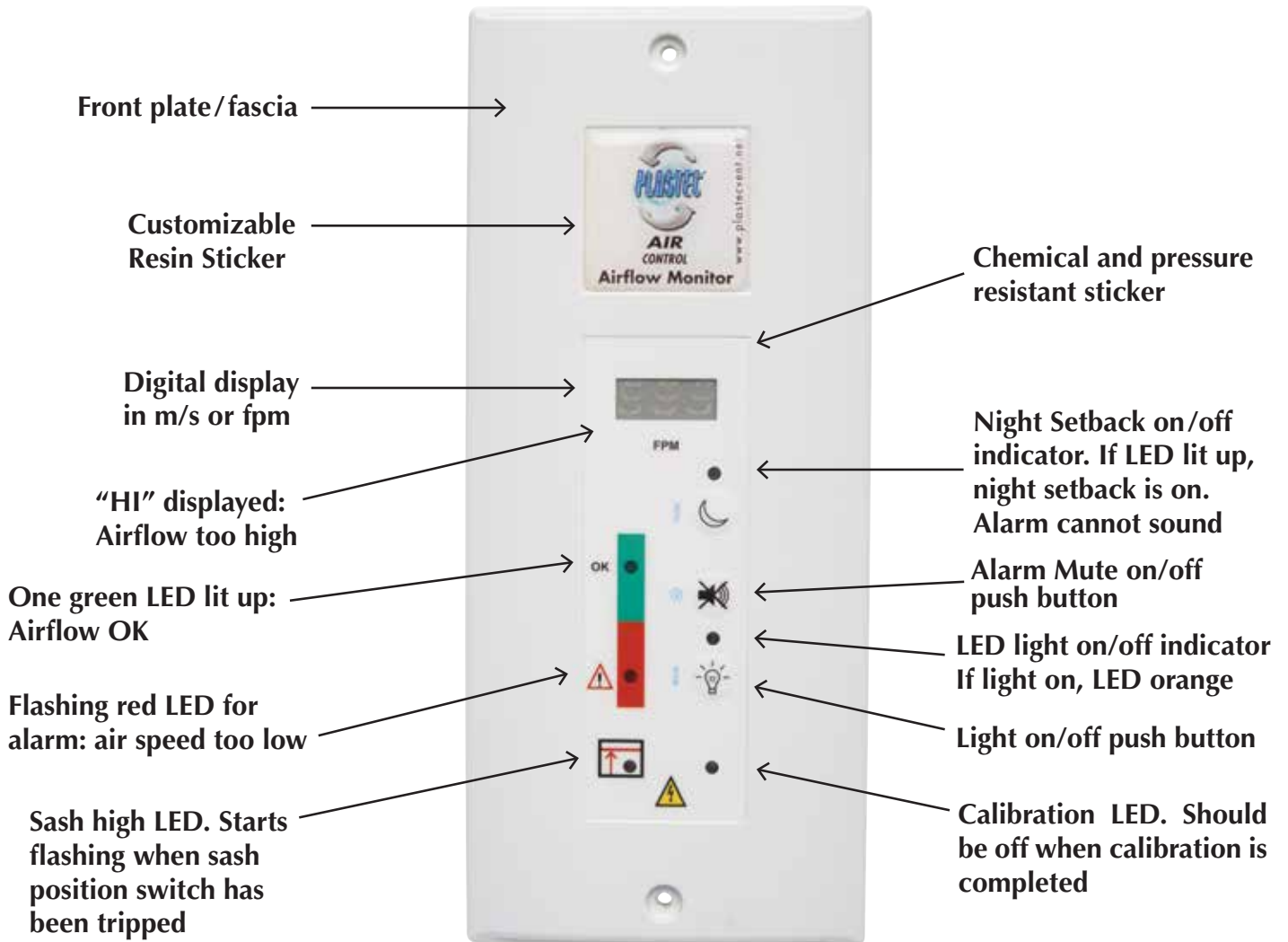

Laboratory Airflow Monitors & Controls

TYPE C STANDARD & NIGHT SETBACK

LED & DIGITAL - VAV SYSTEM

Contacts & Features

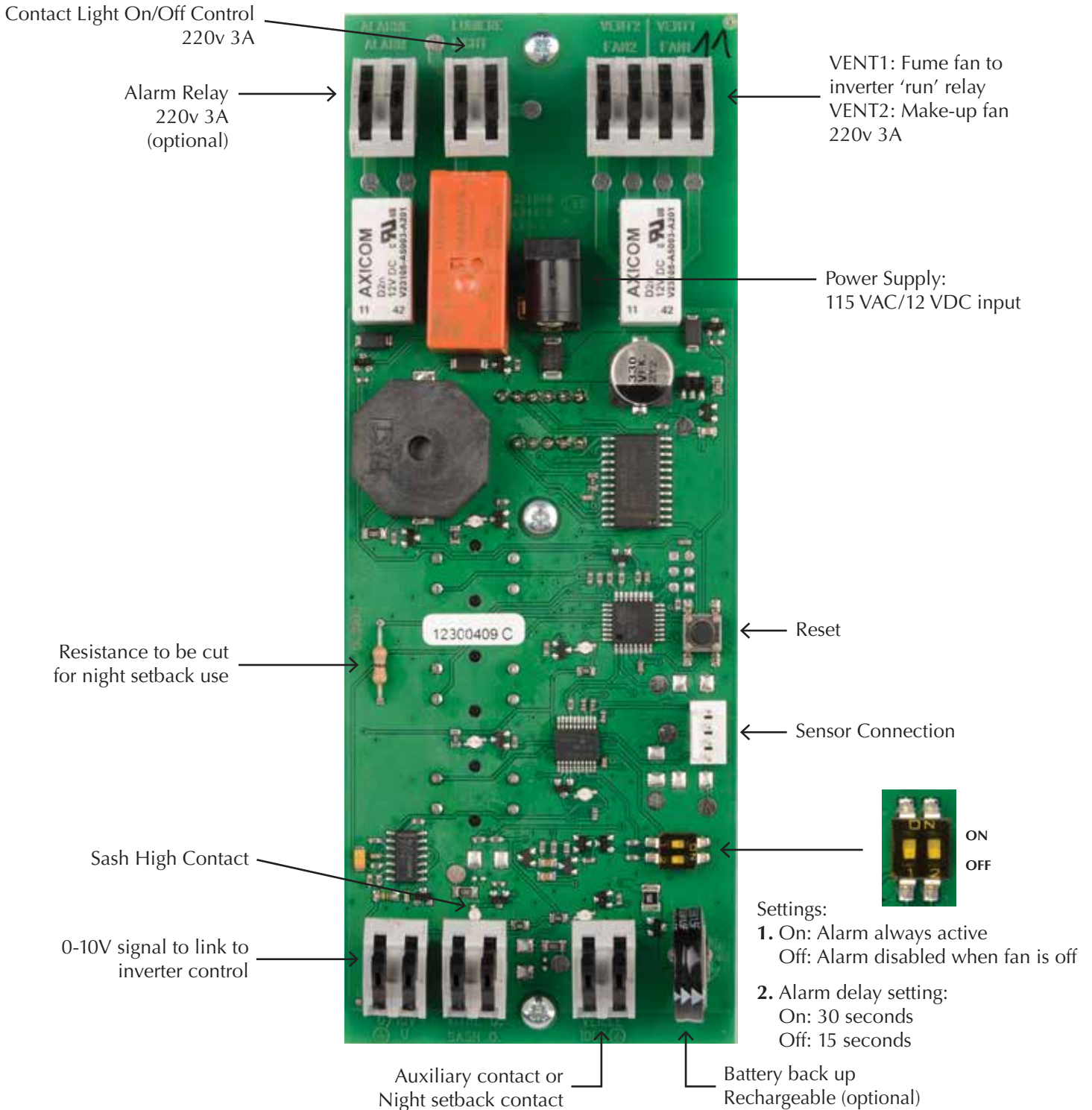

Laboratory Airflow Monitors & Controls

TYPE C STANDARD & NIGHT SETBACK

LED & DIGITAL - VAV SYSTEM









Installation, Calibration & Alarm Test

INSTALLATION

- 1) Drill a \varnothing 23mm / 0.91" hole either in the top or side of the fume cupboard to allow sensor positioning. Make sure sensor is not in a turbulent zone where the pressure can fluctuate but where it can monitor stable changes in pressure. Attention should be paid to **dead zones** near the top of the fume cupboard.
- 2) Proceed with wiring as seen on page "Contacts & Features".
- 3) Position and secure monitor to service panel of the fume cupboard with the two self-tapping screws supplied. Do not forget to position "O" ring seal into the moulded groove in the back of the face plate.



CONTROLLER SET UP PROCEDURE

All monitors unless indicated otherwise are factory pre-calibrated at **0.5 m/s** or **100 FPM**. If you need a different sensor calibration and/or displayed speed reading:

- 1) Make sure that controller is properly linked to inverter and that the ventilation is working. You need an anemometer to do this set up.
- 2) Push  for more than 5 seconds, then release and push simultaneously   for Standard or   for Night Setback within the following 5 seconds. Buzzer sounds twice, the green LED is on and the red LED is flashing indicating controller is in manual set up mode.
- 3) Raise the fume cupboard to its test height e.g. 500mm/19.69".
- 4) Push  or  to increase or to decrease  the fan speed via the inverter until the anemometer is reading required air speed. Every button press increases or decreases the speed of 0.5V producing one beep.

The maximum value is 10V, the minimum is 0.3V.

For model without digital display (819703), please go directly to step 6.

- 5) *For digital display model (819704), press "Reset" button at the back of the controller to change the required speed display from 0.3 m/s/59 FPM to 0.7 m/s/138 FPM, using  and . The value will be memorized as the set point.*
- 6) Wait for 15 seconds or so for air speed to stabilize.
- 7) To return to "AUTO" mode, push  again until the buzzer beeps 3 times (about 3 seconds) and the green LED is illuminated: new calibration (above or equal at 0.2 m/s) is accepted.

This is automatically done after 7 minutes in manual mode.

The buzzer beeps 10 times in case of incorrect calibration.

All updated information is stored in an internal memory which saves and holds the data even in case of power cut.

Laboratory Airflow Monitors & Controls

TYPE C STANDARD & NIGHT SETBACK

LED & DIGITAL - VAV SYSTEM

Installation, Calibration & Alarm Test

VELOCITY TYPE

To change Digital readout from/to m/s to FPM:

Press simultaneously the following buttons:   until buzzer sounds (about 5 seconds).

DISPLAY MESSAGES

The display will show “HI” for an airflow superior to 1 m/s / 96 FPM and “LO” for an airflow inferior to 0.20 m/s / 40 FPM.

In case of faulty, improper or absent sensor, the display will show “PB”.

FACTORY DATA RESET

Press “Reset” (at the back of the controller) for 15 seconds. Buzzer sounds 5 times.

When using this feature, you restore factory default settings: set point and display at 0.5 m/s / 100 FPM, 7V output to the inverter and all relays and LEDs deactivated.

This operation should be imperatively done in “Auto” mode.

TEST MODE

Test mode is to confirm that all functions are operational. To access test mode, follow this procedure:

1) Press simultaneously following buttons:    for 2 seconds for Standard or    for 2 seconds for Night Setback

* Buzzer sounds twice

2) Press the 3 buttons alternately.

* Buzzer sounds 3 times indicating normal operating mode

* Buzzer sounds 10 times if malfunction

In case of faulty sensor, the display will show “PB”.

Laboratory Airflow Monitors & Controls

TYPE C STANDARD & NIGHT SETBACK

LED & DIGITAL - VAV SYSTEM

Maintenance, Troubleshooting & Warranty

MAINTENANCE

Front plate and stickers of airflow monitor may be cleaned with mild soap and water on a damp cloth to remove finger marks, oils and residue. Do not use abrasives. Do not allow liquids to enter the plastic casing. Dry the monitor thoroughly after cleaning.

TROUBLESHOOTING

PROBLEM	CHECK
No indicators	Power supply may not be plugged into AC supply.
Improper alarm setpoint	Airflow sensor is factory precalibrated at 0.5 m/s or 100 FPM. Alarm setpoint may not be accurate if sensor is not properly located. Sensor needs to be recalibrated if setpoint is different than 0.5 m/s or 100 FPM. Follow Sensor Recalibration Procedure on page 6.
Alarm is too sensitive, buzzer rings often for short periods of time	Change alarm delay setting to 15s or 30s if already set to 0. See contact & features section.

WARRANTY

PLASTE[®]C Ventilation, Inc. warrants its equipment, products and parts, to be free from defects in workmanship and material under normal use and service for one year after delivery to the first user. Product must be returned to point of purchase, with dated bill of sale, within one year of purchase. If factory return is required, please contact distributor first.