

# CASSETTE GRILLE INSTALLATION MANUAL

For authorized service personnel only.

English

Français

Español





## 1. SAFETY PRECAUTIONS

 <b>WARNING</b>	Indicates a potentially or imminently hazardous situation which, if not avoided, could result in death or serious injury.
For the air conditioner to operate satisfactorily, install as outlined in this manual.	
Do not turn on the power until all installation work is complete.	
Never touch electrical components immediately after the power supply has been turned off. Electric shock may occur. After turning off the power, always wait 5 minutes or more before touching electrical components.	

 <b>CAUTION</b>	Indicates a potentially hazardous situation that may result in minor or moderate injury or damage to property.
The louver angle cannot be changed if the power is not on. (If moved by hand, it may be damaged.)	
Please refer to the installation manual attached to the indoor unit during installation.	
Hand this manual to the customer to keep for future use, such as for maintenance.	
Do not suspend very heavy weights from the intake grille.	

## 2. ACCESSORIES

- The following installation parts are furnished. Use them as required.

Name and shape	Q'ty	Application
Installation Manual 	1	(This manual)
Hexagon Screw 	4	For mounting decoration panel
Washer 	4	For mounting decoration panel
Tapping screw 	2	For installing grille holding wire
Strap 	4	For installing corner panel

## 3. INSTALLATION PROCEDURE

### 3.1. Removing the Intake grille

- Push the intake grille push-buttons (2 places).
- Open and remove the intake grille.
- Remove the corner panel (4 places).
- Insert the hexagon screw and attach the washer so that it does not fall.

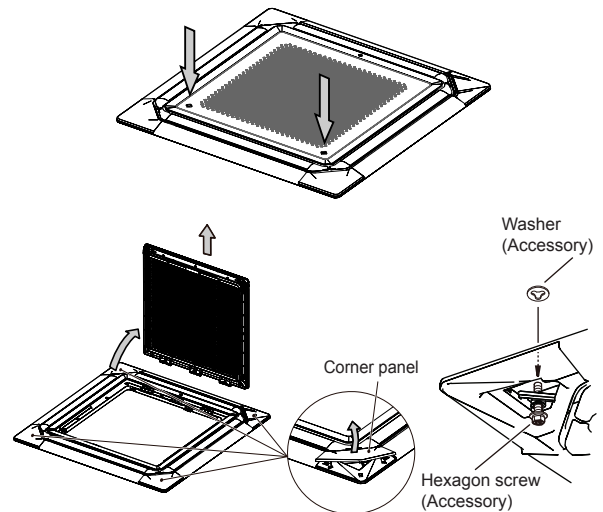

### 3.2. Installing the panel to indoor unit

When installing the main indoor unit, refer to the instructions on the installation manual of the indoor unit.

- Install the decoration panel to the indoor unit.
  - Align the stamped marks on the decoration panel against the pipe and the drain of the indoor unit.

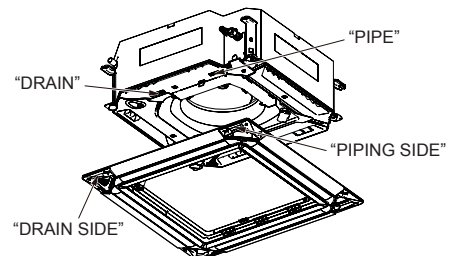

- Attach the decoration panel temporarily at 2 places with metal fittings.

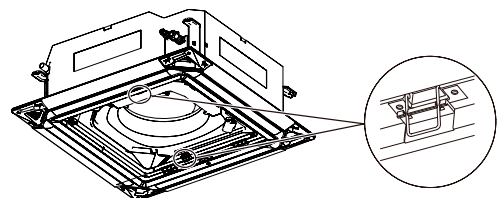

**CAUTION**

- Use only the supplied screws to install the decoration panel.
- Install so that there is no gap between the decoration panel and the main indoor unit.
- If there is a gap, an error will occur as shown in the diagram below.

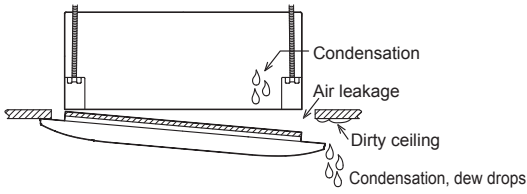

- Tighten the 4 hexagon screws.

Ensure that there is no gap between the hook and the decoration panel (4 places)

No Gap

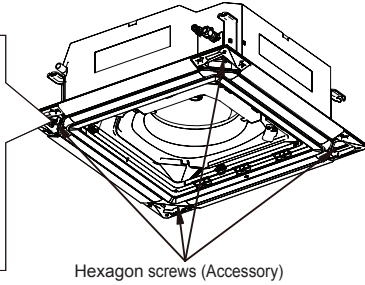

Hexagon screws (Accessory)

When there is a gap between the ceiling and the decoration panel even when the screw is tightened, readjust the height of the main indoor unit.

As long as it does not affect the levelness of the main indoor unit and the drain piping, you may adjust the height of the main indoor unit from the hole at the corner of the decoration panel, with the decoration panel still attached to the main indoor unit.

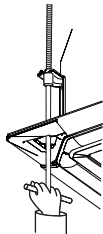

- Tighten the screw until the seal material between the decoration panel and the main indoor unit is compressed to a thickness of 3/16 to 1/4 in (5 to 7 mm).

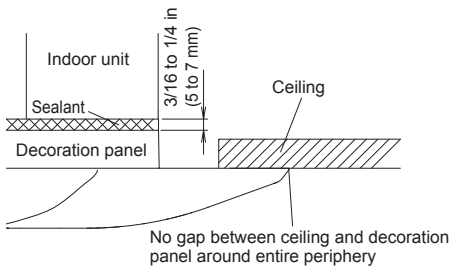

- (2) Install the corner panels.
  - As shown in the following figure, be sure to install the strap to prevent the corner panel from falling down.

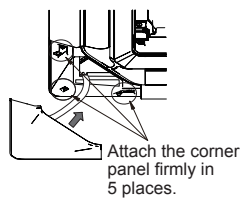
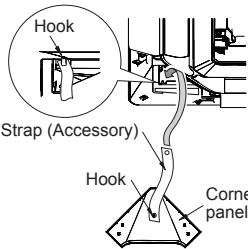

**CAUTION**

Be careful so that no wires or straps are caught between the panels.

- (3) Open the control box cover by loosening the screws.

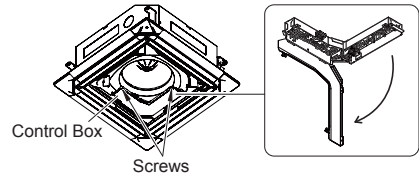

- (4) Connect the cassette grille connector as shown in the following figure.

**Type A**

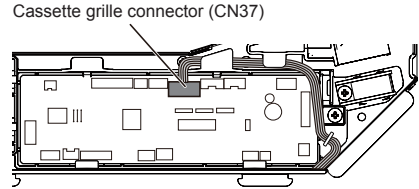

**Type B**

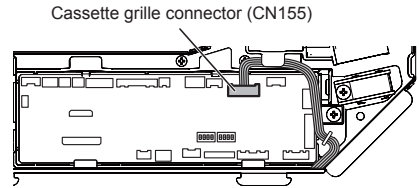

- (5) Close the control box cover and retighten the screws.

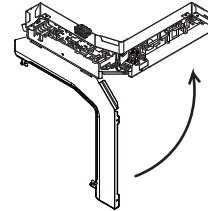

**3.3. Attaching the Intake grille**

- (1) Tighten the 2 grille holding wires.

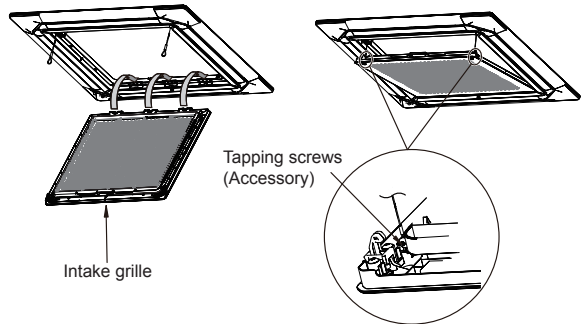

- (2) Close the intake grille.

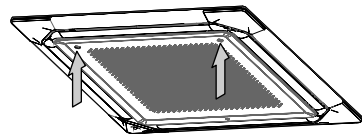

**CAUTION**

Install the grill holding wire to the decoration panel. If it falls, it may cause injuries.