



PROGRAMMABLE THERMOSTAT

INSTALLATION & OWNER'S MANUAL

Model: STN2020

WARNING: DO NOT destroy or lose this manual. Please read the manual thoroughly before installing or operating the controller. Also, store the manual in a place that allows for easy retrieval and future reference. The actual shape and size of your product may vary.

VERSION DATE: 03-02-26

THERMOSTAT QUICK REFERENCE

Thermostat Applications Guide

Description	
Gas or Oil Heat	Yes
Electric Furnace	Yes
Heat Pump (No Aux. or Emergency Heat)	Yes
Heat Pump (With Aux. or Emergency Heat)	No
Multi-Stage Systems	No
Heat Only Systems	Yes
Heat Only Systems - Floor or Wall Furnace	Yes
Cool Only Systems	Yes
Millivolt Conventional Systems	Yes
Two Transformer Systems	Yes

Table of Contents

Page

Thermostat Quick Reference	2-6
Installation Tips	7-13
Wiring Diagrams	14-16
Technician Setup	17-20
Set Time	21
Programming	22-24
Specifications	25

Power Type

Battery Power

Hardwire (Common Wire)

IMPORTANT SAFETY INFORMATION WARNING:



- Always turn off power at the main power source by unscrewing fuse or switching circuit breaker to the off position before installing, removing, cleaning, or servicing thermostat.
- Read all of the information in this manual before installing or programming this thermostat.
- This is a 24V AC low voltage thermostat. Do not install on voltages higher than 30V AC.
- All wiring must conform to local and national building and electrical codes and ordinances.
- Do not short (jumper) across terminals on the gas valve or at the system control to test installation. This will damage the thermostat and void the warranty.

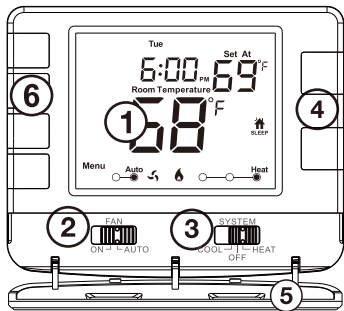

Getting to know your thermostat



- ① LCD Display
- ② Fan Switch
- ③ System Switch
- ④ Temperature Setpoint Buttons
- ⑤ Switch face door(Use the finger bevel on the lower portion of the thermostat to open the easy access)
- ⑥ User Buttons

Temporary and Permanent Hold Feature (if using programming)

Temporary Hold: The thermostat will display **HOLD** and **RUN SCHED** on the left of your screen when you press the  or  key. If you do nothing, the temperature will remain at this setpoint temporarily until next time period. Your program setpoint will then replace your temporary setpoint.

Permanent Hold: If you press the **HOLD** key at the left of your screen, you will see **HOLD** appear below the setpoint temperature in the display. The thermostat will now permanently stay at this setpoint and can be adjusted using the  or  keys.

To return to program: Press the **RUN SCHED** key at the left of your screen to exit either temporary or permanent hold.

THERMOSTAT QUICK REFERENCE

Filter Change Reminder

If your HVAC contractor has configured the thermostat to remind you when the air filter needs to be changed, you will see **FILTER** in the display when your air filter needs to be changed.

Resetting the filter change reminder: When **FILTER** reminder is displayed, you should change your air filter and reset the reminder by holding down the second button from the top left side of the thermostat (Clean) for 3 seconds.

Hold down 3 seconds,
to reset filter reminder.

Factory data reset

Press Menu key and switch
on the power supply to
restore factory, Settings
after normal display

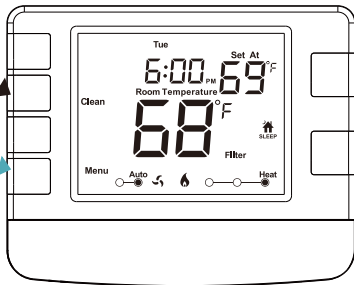

Wall Locations

The thermostat should be installed approximately 4 to 5 feet above the floor. Select an area with average temperature and good air circulation.

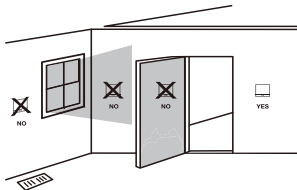

Installation Tip

Pick an installation location that is easy for the user to access. The temperature of the location should be representative of the building.

Do not install thermostat in locations:

- Close to hot or cold air ducts
- That are in direct sunlight
- With an outside wall behind the thermostat
- In areas that do not require conditioning
- Where there are dead spots or drafts (in corners or behind doors)
- Where there might be concealed chimneys or pipes

INSTALLATION TIPS

1 Turn Off the Power of Your Heating/Cooling System

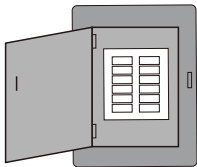

Circuit breaker
box

or



Heating/cooling system
power switch

2 Remove Old Thermostat -(If Any)

Remove the old thermostat , but leave the wallplate with wires attached.

Do not remove wallplate yet

Terminal
designation

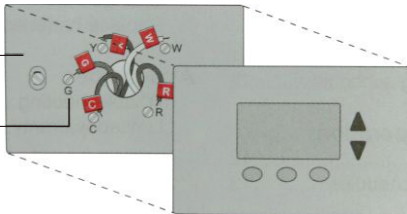

3 Label Wires with Tags

Label the wires using the supplied wire labels as you disconnect them.

Wiring Labels		Étiquettes de fils		Rótulos para los cables					
Apply these wiring labels to each wire with the appropriate terminal designation as you remove it from the existing thermostat.		Lorsque vous retirez les fils des bornes du thermostat existant, collez ces étiquettes sur chaque fil correspondant à la lettre de la borne.		Coloque estos rótulos, con la designación de los terminales, en cada cable al remover los cables del termostato actual.					
B	B	Y2	Y2	C	C	E	E	F	F
G	G	H	H	L	L	O	O	P	P
R	R	RC	RC	RH	RH	T	T	U	U
VVR	VVR	W	W	W1	W1	W2	W2	W3	W3
X	X	X1	X1	X2	X2	Y	Y	Y1	Y1
AUX	AUX								

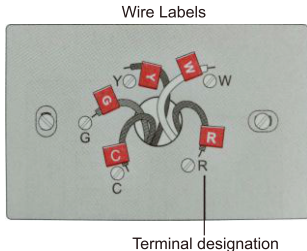

4. Remove the old wall panels

Remove the old wall panels so that the new ones can be installed.

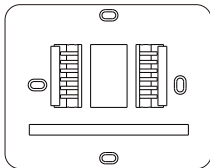

INSTALLATION TIPS

5 Mount New Wallplate

Mount the new wallplate using the included screws and anchors.

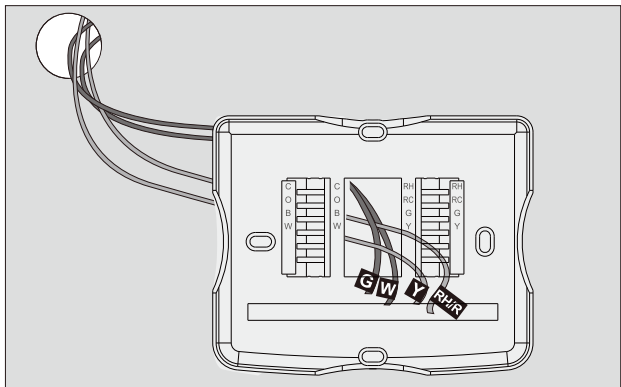

Drill 3/16-in. holes for drywall
Drill 3/16-in. holes for plaster



Mercury Notice:

All of our products are mercury free. However, if the product you are replacing contains mercury, dispose of it properly. Your local waste management authority can give you instructions on recycling and proper disposal.

For vertical mount put one screw top and one screw bottom.

For horizontal mount put one screw left and one screw right.

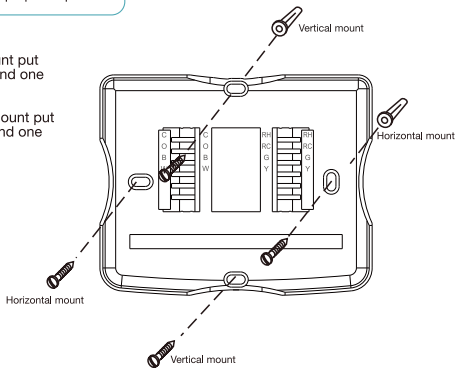

INSTALLATION TIPS

6 Connect Wires

Simply match wire labels to the letters on the thermostat.

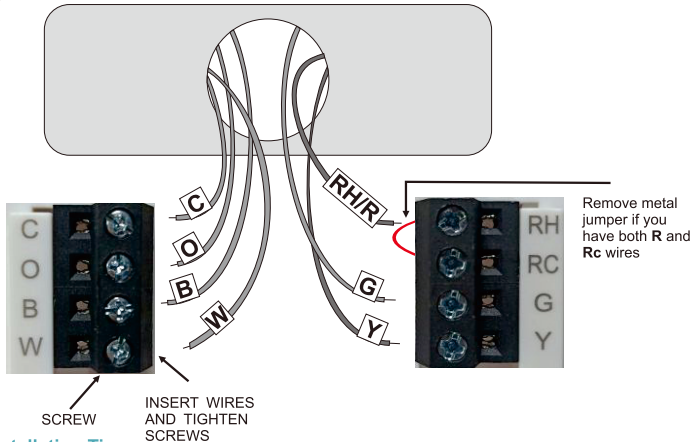

Installation Tip

Do not overtighten terminal block screws, as this can damage the terminal block. A damaged terminal block can keep the thermostat from fitting on the subbase correctly or cause system operation issues. Max Torque = 6in-lbs.

7 Mount Thermostat

Align the 2 tabs on the subbase with corresponding slots on the back of the thermostat, then push gently until the thermostat snaps in place.

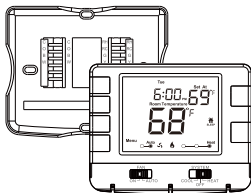

Battery Installation

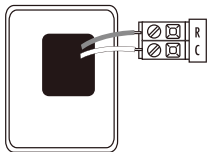

Battery installation is optional if used with AC power (the C terminal is connected). During power outages, the batteries will save settings and power the display.

Important:

High quality alkaline batteries are recommended. Rechargeable batteries or low quality batteries are not recommended.

Insert 2 AAA Alkaline batteries. High quality alkaline batteries are recommended.

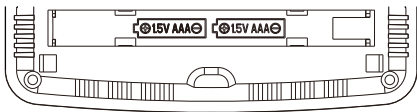

Terminal	1 Heat 1 Cool Conventional System	
RC	COOL=RC to Y O	FAN=RC TO G
RH	24VAC(system power supply)	HEAT=RH TO W B
C	COMMON 24VAC (system power supply)	
B	REVVALVE HEAT	
O	REVVALVE COOL	
G	FAN RELAY	
W	HEAT RELAY	
Y	COOL RELAY	

Wiring Tips

Common wire

The C (common wire) is optional when the thermostat is powered by batteries.

Wire Specifications

Use 18- to 22-gauge thermostat wire. Shielded wire is not required.

- 1 Power supply
- 2 Factory-installed jumper. Remove only when installing on 2-transformer systems.
- 3 Use either O or B terminals for changeover valve
- 4 Use a small piece of wire (not supplied) to connect W and Y terminals
- 5 Set fan operation switch to electric
- 6 Optional 24 VAC common connection when thermostat is used in battery power mode

Typical 1H/1C system: 1 transformer

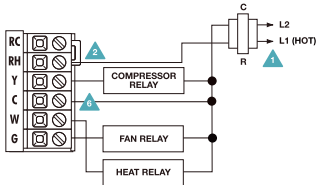

Typical 1H/1C system: 2 transformer

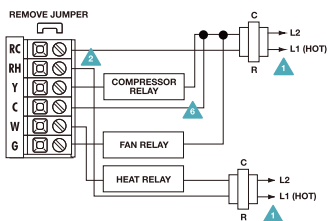

WIRING DIAGRAMS

Typical 1H/1C heat pump system

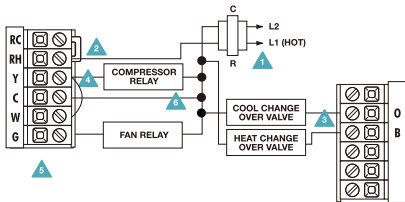

Typical heat-only system

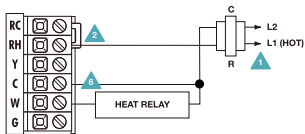



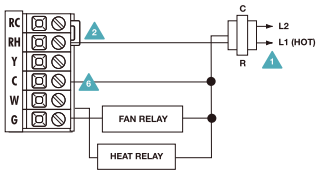

Typical heat-only system with fan

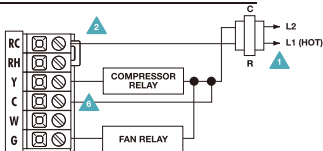

Typical cool-only system



1. Press MENU button
2. Press and hold **TECH Set** button for 3 seconds. This 3 second delay is designed so that homeowners do not accidentally access the installer settings.
3. Configure the installer options as desired using the table below.
4. Use the  or  keys to change settings and the NEXT STEP or PREV key to move from one step to another. Note: Only press DONE key when you want to exit the Technician Setup options.

Tech Setup Steps	LCD Will Show	Adjustment Options	Default
Filter Change Reminder		You can adjust the filter change reminder from OFF to 2000 hours of runtime in 50 hour increments.	OFF
Room Temperature Calibration		You can adjust the room temperature display to read 4° above or below the factory calibrated reading.	0

TECHNICIAN SETUP

Tech Setup Steps	LCD Will Show	Adjustment Options	Default	
Minimum Compressor On Time	<p>This feature allows the installer to select the minimum run time for the compressor. For example: a setting of 4 will force the compressor to run for at least 4 minutes every time the compressor turns on, regardless of the room temperature.</p>	<p>OFF ON AN</p>	<p>You can select the minimum compressor run time from "off", "3", "4", or "5" minutes. If 3, 4, or 5 is selected, the compressor will run for at least the selected time before turning off.</p>	OFF
Compressor Short Cycle Delay	<p>The compressor short cycle delay protects the compressor from short cycling. This feature will not allow the compressor to be turned on for 5 minutes after it was last turned off.</p>	<p>ON OF CO</p>	<p>Selecting "ON" will not allow the compressor to be turned on for 5 minutes after the last time the compressor was switched off. Select "OFF" to remove this delay.</p>	ON
Cooling Swing	<p>The swing setting often called "cycle rate", "differential" or "anticipation" is adjustable. A smaller swing setting will cause more frequent cycles and a larger swing setting will cause fewer cycles.</p>	<p>dF CO 0.5 °F</p>	<p>The cooling swing setting is adjustable from 0.2° to 2°. For example: A swing setting of 0.5° will turn the cooling on at approximately 0.5° above the setpoint and turn the cooling off at approximately 0.5° below the setpoint.</p>	0.5

Tech Setup Steps	LCD Will Show	Adjustment Options	Default
<p>Heating Swing</p>	<p>The swing setting often called “cycle rate”, “differential” or “anticipation” is adjustable. A smaller swing setting will cause more frequent cycles and a larger swing setting will cause fewer cycles.</p>	<p>The heating swing setting is adjustable from 0.2° to 2°. For example: A swing setting of 0.5° will turn the heating on at approximately 0.5° below the setpoint and turn the heating off at approximately 0.5° above the setpoint.</p>	<p>0.4</p>
<p>Heating Setpoint Limit</p>	<p>This feature allows you to set a maximum heat setpoint value. The setpoint temperature cannot be raised above this value.</p>	<p>Use the $\boxed{+}$ and $\boxed{-}$ key to select the maximum heat setpoint. Range 44°F- 90°F</p>	<p>90</p>
<p>Cooling Setpoint Limit</p>	<p>This feature allows you to set a minimum cool setpoint value. The setpoint temperature cannot be lowered below this value.</p>	<p>Use the $\boxed{+}$ and $\boxed{-}$ key to select the minimum cool setpoint. Range 44°F- 90°F</p>	<p>44</p>

TECHNICIAN SETUP

Tech Setup Steps	LCD Will Show	Adjustment Options	Default
<p>F° or C°</p>	<p>Select F for Fahrenheit read out or select C for Celsius read out.</p>	<p>°F for Fahrenheit °C for Celsius</p>	<p>°F</p>
<p>12 or 24 Hour Clock</p>	<p>You can select either 12 or 24 hour clock setting.</p>	<p>Use the <input type="checkbox"/>- or <input type="checkbox"/>+ key to select 12 or 24 hour clock.</p>	<p>12 H</p>
<p>Fan Operation</p>	<p>Select GAS for systems that control the fan during a call for heat. Select ELEC to have the thermostat control the fan during a call for heat.</p>	<p>ELEC = Electric for thermostat control GAS = Gas for system control</p>	<p>GAS</p>
<p>Program Options</p>	<p>You can configure this thermostat to have a 7 day program, a 5+1+1 program or nonprogrammable.</p>	<p>Use the <input type="checkbox"/>- or <input type="checkbox"/>+ key to select 7d for 7 day, 5d for 5+1+1, or 0d for non-programmable.</p>	<p>5d</p>





Set Time

1. Press the **MENU** button
2. Press **SET TIME**
3. Day of the week will be flashing. Use the or key to select the current day of the week.
4. Press **NEXT STEP**
5. The current hour is flashing. Use the or key to select the current hour. When using 12-hour time, make sure the correct a.m. or p.m. choice is selected.
6. Press **NEXT STEP**
7. Minutes are now flashing. Use the or key to select current minutes.
8. Press **DONE** when completed.

PROGRAMMING

Set Program Schedule 5+1+1 or 7Day

To customize your program schedule, follow these steps:

1. Select **HEAT** or **COOL** with the system switch. **Note:** You have to program heat and cool each separately.
2. Press the **MENU** button (If menu does not appear first press **RUN SCHED**)
3. Press **SET SCHED**. Note: Monday-Friday or (**Monday if in 7 Day**) is displayed and the **WAKE** icon is shown. You are now programming the wake time period for that day.
4. Time is flashing. Use the  or  key to make your time selection for that day's **WAKE** time period.
5. Press **NEXT STEP**
6. The setpoint temperature is flashing. Use the  or  key to make your setpoint selection for that day's **WAKE** time period.
7. Press **NEXT STEP**
8. Repeat steps 4 thru 7 for that day's **LEAVE** time period, **RETURN** time period, and **SLEEP** time period.

Continued on next page...

Set Program Schedule 5+1+1 or 7Day

Saturday:

Repeat steps 4 through 7 for the Saturday **WAKE** time period, **LEAVE** time period, **RETURN** time period, and for the Saturday **SLEEP** time period.

Sunday:

Repeat steps 4 through 7 for the Sunday **WAKE** time period, **LEAVE** time period, **RETURN** time period, and for the Sunday **SLEEP** time period.

PROGRAMMING

Programming

All of our programmable thermostats are shipped with an energy saving pre-program. Your thermostat can be programmed to have all the weekdays the same, a separate program for Saturday, and a separate program for Sunday. There are four time periods for each program (**WAKE, LEAVE, RETURN, SLEEP**).

Factory Default Program				
Day of the Week	Events	Time	Setpoint Temperature (HEAT)	Setpoint Temperature (COOL)
Weekday	Wake	6 AM	70°F (21°C)	75°F (24°C)
	Leave	8 AM	62°F (17°C)	83°F (29°C)
	Return	6 PM	70°F (21°C)	75°F (24°C)
	Sleep	10 PM	62°F (17°C)	78°F (26°C)
Saturday	Wake	8 AM	70°F (21°C)	75°F (24°C)
	Leave	10 AM	62°F (17°C)	83°F (29°C)
	Return	6 PM	70°F (21°C)	75°F (24°C)
	Sleep	11 PM	62°F (17°C)	78°F (26°C)
Sunday	Wake	8 AM	70°F (21°C)	75°F (24°C)
	Leave	10 AM	62°F (17°C)	83°F (29°C)
	Return	6 PM	70°F (21°C)	75°F (24°C)
	Sleep	11 PM	62°F (17°C)	78°F (26°C)

Specifications

The display range of temperature	-----	32°F to 99°F (0°C to 40°C)
The control range of temperature	-----	44°F to 90°F (7°C to 32°C)
Load rating	-----	1 amp per terminal, 1.5 amp maximum all terminals combined
Display accuracy	-----	± 1°F
Swing (cycle rate or differential)	-----	Heating is adjustable from 0.2°F to 2.0°F Cooling is adjustable from 0.2°F to 2.0°F
Power source	-----	18 to 30 VAC, NEC Class II, 50/60 Hz for hardwire (common wire) Battery power from 2 AAA Alkaline Energizer batteries
Operating ambient	-----	32°F to +105°F (0°C to +41°C)
Operating humidity	-----	90% non-condensing maximum
Dimensions of thermostat	-----	4.72"W x 3.86"H x 1.02"D

Instruction Manual