

ACiQ

AC-COOLING ONLY R454B CONDENSER (18K-60K AC-B Models)

INSTALLATION MANUAL

Models Covered:

ACiQ-18-AC-B

ACiQ-24-AC-B

ACiQ-30-AC-B

ACiQ-36-AC-B

ACiQ-48-AC-B

ACiQ-54-AC-B

ACiQ-60-AC-B



WARNING: DO NOT destroy or lose this manual. Please read the manual thoroughly. Also, store the manual in a place that allows for easy retrieval and future reference. As a result of continuous product improvement, the specification and design of this product are subject to change without advanced notice. Consult your manufacturer or your dealer for further details regarding this product. The images and illustrations within this this manual are for reference only. The actual shape and size of your product may vary.

VERSION DATE: 03-02-26

CONTENTS

| | |
|-------------------------------------|----|
| SAFETY PRECAUTIONS | 02 |
| ACCESSORIES | 16 |
| REFRIGERANT PIPING CONNECTION | 17 |
| OUTDOOR UNIT INSTALLATION | 21 |
| WIRING PRECAUTIONS | 25 |
| SPECIFICATION | 31 |
| AIR EVACUATION | 34 |
| NOTE ON ADDING REFRIGERANT | 35 |
| TEST RUN | 36 |

Read this manual

Inside you'll find many helpful hints on how to use and maintain your air conditioner properly. Just a little preventive care on your part can save you a great deal of time and money over the life of your air conditioner. These instructions may not cover every possible condition of use, so common sense and attention to safety is required when installing, operating and maintaining this product.

SAFETY PRECAUTIONS

It is really important you read Safety Precautions Before Operation and Installation. Incorrect installation due to ignoring instructions can cause serious damage or injury. The seriousness of potential damage or injuries is classified as either a WARNING or CAUTION.

Explanation of Symbols



WARNING

This symbol indicates the possibility of personal injury or loss of life.



CAUTION

This symbol indicates the possibility of property damage or serious consequences.

WARNING

This appliance is not intended for use by persons (including children) with reduced physical, sensory or mental capabilities, or lack of experience and knowledge, unless they have been given supervision or instruction concerning use of the appliance by a person responsible for their safety. Children should be supervised to ensure that they do not play with the appliance.

ELECTRICAL WARNINGS

- Only use the specified wire. If the wire is damaged, it must be replaced by the manufacturer, its service agent or similarly qualified persons in order to avoid a hazard.
- The product must be properly grounded at the time of installation, or electric shock may occur.
- For all electrical work, follow all local and national wiring standards, regulations, and the Installation Manual. Connect cables tightly, and clamp them securely to prevent external forces from damaging the terminal. Improper electrical connections can overheat and cause fire, and may also cause shock. All electrical connections must be made according to the Electrical Connection Diagram located on the panels of the indoor and outdoor units.
- All wiring must be properly arranged to ensure that the control board cover can close properly. If the control board cover is not closed properly, it can lead to corrosion and cause the connection points on the terminal to heat up, catch fire, or cause electrical shock.
- Disconnection must be incorporated in the fixed wiring in accordance with the wiring rules.
- Do not share the electrical outlet with other appliances. Improper or insufficient power supply can cause fire or electric shock.
- If connecting power to fixed wiring, an all-pole disconnection device must be incorporated in the fixed wiring in accordance with the wiring rules.

⚠ WARNINGS FOR PRODUCT INSTALLATION

- Turn off the air conditioner and disconnect the power before performing any installation or repairing. Failure to do so can cause electric shock.
- Installation must be performed by an authorized dealer or specialist. Defective installation can cause water leakage, electrical shock, or fire.
- Installation must be performed according to the installation instructions. Improper installation can cause water leakage, electrical shock, or fire. Contact an authorized service technician for repair or maintenance of this unit.
- This appliance shall be installed in accordance with national wiring regulations. Only use the included accessories, parts, and specified parts for installation.
- Using non-standard parts can cause water leakage, electrical shock, fire, and can cause the unit to fail.
- Install the unit in a firm location that can support the unit's weight. If the chosen location cannot support the unit's weight, or the installation is not done properly, the unit may drop and cause serious injury and damage.
- Install drainage piping according to the instructions in this manual. Improper drainage may cause water damage to your home and property.
- For units that have an auxiliary electric heater, do not install the unit within 1 meter (3 feet) of any combustible materials.
- For the units that have a wireless network function, the USB device access, replacement, maintenance operations must be carried out by professional staff.
- Do not install the unit in a location that may be exposed to combustible gas leaks. If combustible gas accumulates around the unit, it may cause fire.
- Do not turn on the power until all work has been completed.
- When moving or relocating the air conditioner, consult experienced service technicians for disconnection and reinstallation of the unit.
- How to install the appliance to its support, please read the information for details in "indoor unit installation" and "outdoor unit installation" sections.

TAKE NOTE OF FUSE SPECIFICATIONS

The air conditioner's circuit board (PCB) is designed with a fuse to provide overcurrent protection. The specifications of the fuse are printed on the circuit board, for example: T3.15AL/250VAC, T5AL/250VAC, T3.15A/250VAC, T5A/250VAC, T20A/250VAC, T30A/250VAC, etc.

NOTE: Only the blast-proof ceramic fuse can be used.

⚠ WARNINGS FOR CLEANING AND MAINTENANCE

- Turn off the device and disconnect the power before cleaning. Failure to do so can cause electrical shock.
- **Do not** clean the air conditioner with excessive amounts of water.
- **Do not** clean the air conditioner with combustible cleaning agents. Combustible cleaning agents can cause fire or deformation.

⚠ WARNING FOR USING FLAMMABLE REFRIGERANT

1. Installation (Space)
 - That the installation of pipe-work shall be kept to a minimum.
 - That pipe-work shall be protected from physical damage.
 - Where refrigerant pipes shall be compliance with national gas regulations.
 - That mechanical connections shall be accessible for maintenance purposes.
 - In cases that require mechanical ventilation, ventilation openings shall be kept clear of obstruction.
 - When disposing of the product is used, be based on national regulations, properly processed.
2. Servicing
 - Any person who is involved with working on or breaking into a refrigerant circuit should hold a current valid certificate from an industry-accredited assessment authority, which authorizes their competence to handle refrigerants safely in accordance with an industry recognized assessment specification.
3. Maintenance and repair requiring the assistance of other skilled personnel shall be carried out under the supervision of the person competent in the use of flammable refrigerants.
4. Do not use means to accelerate the defrosting process or to clean, other than those recommended by the manufacturer.
5. The appliance shall be stored in a room without continuously operating ignition sources (for example: open flames, an operating gas appliance or an operating electric heater).
6. Be more careful that foreign matter(oil, water, etc.) does not enter the piping. Also, when storing the piping, securely seal the opening by pinching, taping, etc.
7. Do not pierce or burn.
8. Be aware that refrigerants may not contain an odour.
9. All working procedure that affects safety means shall only be carried by competent persons.
10. Appliance shall be stored in a well-ventilated area where the room size corresponds to the room area as specific for operation.
11. The appliance shall be stored so as to prevent mechanical damage from occurring.
12. Joints shall be tested with detection equipment with a capability of 5 g/year of refrigerant or better, with the equipment in standstill and under operation or under a pressure of at least these standstill or operation conditions after installation. Detachable joints shall NOT be used in the indoor side of the unit (brazed, welded joint could be used).

For R454B refrigerant charge amount and minimum room area:

The machine you purchased may be one of the types in the table below. The indoor and outdoor units are designed to be used together, and the indoor unit is connected via an air duct system to one or more room. Please check the machine you purchased. The height of the room cannot be less than 7.3ft/2.2m, and the minimum room area of operating or storage should be as specified in the following table:

| Products series | Model | Indoor unit | Outdoor unit |
|-----------------------------------|---------------|---------------------------------------------|---------------------------------------------|
| Ducted Air Handler | 18K(208/230V) | ACiQ-18-AHD | ACiQ-18-EHPD ACiQ-18-HPD ACiQ-18-AC-B |
| | | ACiQ-24-AHD | |
| | 24K(208/230V) | ACiQ-24-AHD | ACiQ-24-EHPD ACiQ-24-HPD ACiQ-24-AC-B |
| | 30K(208/230V) | ACiQ-30-AHD | ACiQ-30-EHPD ACiQ-30-HPD ACiQ-30-AC-B |
| | | ACiQ-36-AHD | |
| | 36K(208/230V) | ACiQ-36-AHD | ACiQ-36-EHPD ACiQ-36-HPD ACiQ-36-AC-B |
| 48K(208/230V) | ACiQ-48-AHD | ACiQ-48-EHPD ACiQ-48-HPD ACiQ-48-AC-B | |
| | ACiQ-60-AHD | | |
| 60K(208/230V) | ACiQ-60-AHD | ACiQ-60-EHPD ACiQ-60-HPD ACiQ-60-AC-B | |
| Premium Ducted Air Handler | 18K(208/230V) | ACiQ-18-PAH | ACiQ-18-HPD |
| | | ACiQ-24-PAH | |
| | 24K(208/230V) | ACiQ-24-PAH | ACiQ-24-HPD |
| | 30K(208/230V) | ACiQ-30-PAH | ACiQ-30-HPD *1 |
| | | ACiQ-36-PAH | |
| | 36K(208/230V) | ACiQ-36-PAH | ACiQ-36-HPD |
| 48K(208/230V) | ACiQ-48-PAH | ACiQ-48-HPD *2 | |
| | ACiQ-60-PAH | | |
| 60K(208/230V) | ACiQ-60-PAH | ACiQ-60-HPD | |

[*1]: For this product combination, an additional 0.60kg/21.16 oz of refrigerant is required.

[*2]: For this product combination, an additional 0.65kg/22.93 oz of refrigerant is required.

| Products series | Model | Indoor unit | Outdoor unit |
|---------------------------------------------------------------------------|---------------|--------------------|---------------------|
| Ducted Wall Mount AHU Standard Heat Series | 18K(208/230V) | ACiQ-18W-WMB | ACiQ-18-EHPD |
| | 24K(208/230V) | ACiQ-24W-WMB | ACiQ-24-EHPD |
| | 30K(208/230V) | ACiQ-30W-WMB | ACiQ-30-EHPD |
| | 36K(208/230V) | ACiQ-36W-WMB | ACiQ-36-EHPD |
| Ducted Wall Mount AHU Ext. Heat Series | 18K(208/230V) | ACiQ-18W-WMB | ACiQ-18-HPD |
| | 24K(208/230V) | ACiQ-24W-WMB | ACiQ-24-HPD |
| | 30K(208/230V) | ACiQ-30W-WMB | ACiQ-30-HPD |
| | 36K(208/230V) | ACiQ-36W-WMB | ACiQ-36-HPD |
| Ceiling-Mount PANCAKE-STYLE Air Handler & Standard Heat Series | 18K(208/230V) | ACiQ-18W-PB | ACiQ-18-EHPD |
| | 24K(208/230V) | ACiQ-24W-PB | ACiQ-24-EHPD |
| | 30K(208/230V) | ACiQ-30W-PB | ACiQ-30-EHPD |
| | 36K(208/230V) | ACiQ-36W-PB | ACiQ-36-EHPD |
| Ceiling-Mount PANCAKE-STYLE Air Handler & Ext. Heat Series | 18K(208/230V) | ACiQ-18W-PB | ACiQ-18-HPD |
| | 24K(208/230V) | ACiQ-24W-PB | ACiQ-24-HPD |
| | 30K(208/230V) | ACiQ-30W-PB | ACiQ-30-HPD |
| | 36K(208/230V) | ACiQ-36W-PB | ACiQ-36-HPD |

| Products series | Dimensions | Indoor unit | Outdoor unit |
|------------------------|-------------------|--------------------|------------------------------------------------------------------------------------------------------------|
| A-COILS | 14.5"x21"x18" | ACiQ-24-ACL-14-B | ACiQ-18-EHPD ACiQ-18-HPD ACiQ-18-AC-B |
| | 17.5"x21"x18" | ACiQ-24-ACL-B | ACiQ-18-EHPD ACiQ-18-HPD ACiQ-18-AC-B |
| | 14.5"x21"x18" | ACiQ-24-ACL-14-B | ACiQ-24-EHPD ACiQ-24-HPD ACiQ-24-AC-B |
| | 17.5"x21"x18" | ACiQ-24-ACL-B | ACiQ-24-EHPD ACiQ-24-HPD ACiQ-24-AC-B |
| | 17.5"x21"x24" | ACiQ-36-ACL-17-B | ACiQ-30-EHPD ACiQ-30-HPD ACiQ-36-EHPD ACiQ-36-HPD ACiQ-30-AC-B ACiQ-36-AC-B |
| | 21"x21"x24" | ACiQ-36-ACL-B | ACiQ-30-EHPD ACiQ-30-HPD ACiQ-36-EHPD ACiQ-36-HPD ACiQ-30-AC-B ACiQ-36-AC-B |
| | 21.5"x21.5"x28" | ACiQ-48-ACL-B | ACiQ-48-EHPD ACiQ-48-HPD ACiQ-60-EHPD ACiQ-60-HPD ACiQ-48-AC-B ACiQ-54-AC-B ACiQ-60-AC-B |
| | 24.5"x21"x28" | ACiQ-60-ACL-B | ACiQ-48-EHPD ACiQ-48-HPD ACiQ-60-EHPD ACiQ-60-HPD |

| M_c or M_{REL} [oz/kg] | T_{Amin} [ft²/m²] | M_c or M_{REL} [oz/kg] | T_{Amin} [ft²/m²] | M_c or M_{REL} [oz/kg] | T_{Amin} [ft²/m²] | M_c or M_{REL} [oz/kg] | T_{Amin} [ft²/m²] |
|-----------------------------------------------------------|------------------------------------------------------------------|-----------------------------------------------------------|------------------------------------------------------------------|-----------------------------------------------------------|------------------------------------------------------------------|-----------------------------------------------------------|------------------------------------------------------------------|
| <=62.7/1.776 | 12/1.1 | 134/3.8 | 126/11.67 | 211.6/6.0 | 198/18.43 | 289.2/8.2 | 271/25.18 |
| 63.5/1.8 | 60/5.53 | 141.1/4 | 132/12.29 | 218.7/6.2 | 205/19.04 | 296.3/8.4 | 278/25.8 |
| 70.5/2 | 66/6.14 | 148.1/4.2 | 139/12.9 | 225.8/6.4 | 212/19.66 | 303.4/8.6 | 284/26.41 |
| 77.6/2.2 | 73/6.76 | 155.2/4.4 | 145/13.51 | 232.8/6.6 | 218/20.27 | 310.4/8.8 | 291/27.63 |
| 84.6/2.4 | 79/7.37 | 162.2/4.6 | 152/14.13 | 239.9/6.8 | 225/20.88 | 317.5/9.0 | 298/27.64 |
| 91.7/2.6 | 86/7.99 | 169.3/4.8 | 159/14.74 | 246.9/7.0 | 231/21.5 | 324.5/9.2 | 304/28.26 |
| 98.8/2.8 | 93/8.6 | 176.4/5 | 165/15.36 | 254/7.2 | 238/22.11 | 331.6/9.4 | 311/28.87 |
| 105.8/3 | 99/9.21 | 183.4/5.2 | 172/15.97 | 261/7.4 | 245/22.73 | 338.6/9.6 | 317/29.48 |
| 112.9/3.2 | 106/9.83 | 190.5/5.4 | 179/16.58 | 268.1/7.6 | 251/23.34 | 345.7/9.8 | 324/30.10 |
| 119.9/3.4 | 112/10.44 | 197.5/5.6 | 185/17.2 | 275.1/7.8 | 258/23.96 | 352.7/10.0 | 331/30.71 |
| 127/3.6 | 119/11.06 | 204.6/5.8 | 192/17.81 | 282.2/8.0 | 264/24.57 | | |

Area
formula

T_{Amin} is the required minimum area of the total conditioned space connected by air ducts in ft²/m².

M_c is the actual refrigerant charge in the system in oz/kg

M_{REL} is the refrigerant releasable charge in oz/kg

h_{inst} is the height of the bottom of the appliance relative to the floor of the room after installation.

WARNING: The minimum room area or minimum room area of conditioned space is based on releasable charge and total system refrigerant charge. T_{Amin} shall refer to the table above for a larger refrigerant charge size than actual charge, if releasable charge and total the system refrigerant charge is not equal to any of the size in the table above.

1. **Installation** (where refrigerant pipes are allowed)

- Any person who is involved with working on or breaking into a refrigerant circuit should hold a current valid certificate from an industry-accredited assessment authority, which authorizes their competence to handle refrigerants safely in accordance with an industry recognized assessment specification.
- Maintenance and repair requiring the assistance of other skilled personnel shall be carried out under the supervision of the person competent in the use of flammable refrigerants.
- That the installation of pipe-work shall be kept to a minimum.
- That pipe-work shall be protected from physical damage.
- Where refrigerant pipes shall be compliance with national gas regulations.
- That mechanical connections shall be accessible for maintenance purposes.
- Be more careful that foreign matter(oil, water, etc.) does not enter the piping. Also, when storing the piping, securely seal the opening by pinching, taping, etc.
- All working procedure that affects safety means shall only be carried by competent persons.
- Appliance shall be stored in a well-ventilated area where the room size corresponds to the room area as specific for operation.
- Joints shall be tested with detection equipment with a capability of 5 g/year of refrigerant or better, with the equipment in standstill and under operation or under a pressure of at least these standstill or operation conditions after installation. Detachable joints shall NOT be used in the indoor side of the unit (brazed, welded joint could be used).
- In cases that require mechanical ventilation, ventilation openings shall be kept clear of obstruction.
- LEAK DETECTION SYSTEM installed. Unit must be powered except for service. For the unit with refrigerant sensor, when the refrigerant sensor detects refrigerant leakage, the indoor unit will display an error code and emit a buzzing sound, the compressor of outdoor unit will immediately stop, and the indoor fan will start running. The service life of the refrigerant sensor is 15 years. When the refrigerant sensor malfunctions, the indoor unit will display the error code "FHCC". The refrigerant sensor cannot be repaired and can only be replaced by the manufacture. It shall only be replaced with the sensor specified by the manufacture.

2. **When a FLAMMABLE REFRIGERANT is used**, the requirements for installation space of appliance and/or ventilation requirements are determined according to

- the mass charge amount (M) used in the appliance,
- the installation location,
- the type of ventilation of the location or of the appliance.
- piping material, pipe routing, and installation shall include protection from physical damage in operation and service, and be in compliance with national and local codes and standards, such as ASHRAE 15, IAPMO Uniform Mechanical Code, ICC International Mechanical Code, or CSA B52. All field joints shall be accessible for inspection prior to being covered or enclosed.
- that protection devices, piping, and fittings shall be protected as far as possible against adverse environmental effects, for example, the danger of water collecting and freezing in relief pipes or the accumulation of dirt and debris;
- that piping in refrigeration systems shall be so designed and installed to minimize the likelihood of hydraulic shock damaging the system;
- that steel pipes and components shall be protected against corrosion with a rustproof coating before applying any insulation;
- that precautions shall be taken to avoid excessive vibration or pulsation;
- the minimum floor area of the room shall be mentioned in the form of a table or a single figure without reference to a formula;
- after completion of field piping for split systems, the field pipework shall be pressure tested with an inert gas and then vacuum tested prior to refrigerant charging, according to the following requirements:
 - a. The minimum test pressure for the low side of the system shall be the low side design pressure and the minimum test pressure for the high side of the system shall be the high side design pressure, unless the high side of the system can

not be isolated from the low side of the system in which case the entire system shall be pressure tested to the low side design pressure.

- b. The test pressure after removal of pressure source shall be maintained for at least 1 h with no decrease of pressure indicated by the test gauge, with test gauge resolution not exceeding 5% of the test pressure.
 - c. During the evacuation test, after achieving a vacuum level specified in the manual or less, the refrigeration system shall be isolated from the vacuum pump and the pressure shall not rise above 1500 microns within 10 min. The vacuum pressure level shall be specified in the manual, and shall be the lessor of 500 microns or the value required for compliance with national and local codes and standards, which may vary between residential, commercial, and industrial buildings.
- field-made refrigerant joints indoors shall be tightness tested according to the following requirements: The test method shall have a sensitivity of 5 grams per year of refrigerant or better under a pressure of at least 0,25 times the maximum allowable pressure. No leak shall be detected.

3. Qualification of workers

Any maintenance, service and repair operations must be required qualification of the working personnel. Every working procedure that affects safety means shall only be carried out by competent persons that joined the training and achieved competence should be documented by a certificate. The training of these procedures is carried out by national training organizations or manufacturers that are accredited to teach the relevant national competency standards that may be set in legislation. All training shall follow the ANNEX HH requirements of UL 60335-2-40 4th Edition.

Examples for such working procedures are:

- breaking into the refrigerating circuit;
- opening of sealed components;
- opening of ventilated enclosures.

4. Checks to the area

Prior to beginning work on systems containing flammable refrigerants, safety checks are necessary to ensure that the risk of ignition is minimised. For repair to the refrigerating system, the following precautions shall be complied with prior to conducting work on the system.

5. Work procedure

Works shall be undertaken under a controlled procedure so as to minimise the risk of a flammable gas or vapour being present while the work is being performed.

6. General work area

All maintenance staff and others working in the local area shall be instructed on the nature of work being carried out. work in confined spaces shall be avoided.

7. Checking for presence of refrigerant

The area shall be checked with an appropriate refrigerant detector prior to and during work, to ensure the technician is aware of potentially flammable atmospheres. Ensure that the leak detection equipment being used is suitable for use with flammable refrigerants, i.e. no sparking, adequately sealed or intrinsically safe.

8. Presence of fire extinguisher

If any hot work is to be conducted on the refrigeration equipment or any associated parts, appropriate fire extinguishing equipment shall be available to hand. Have a dry power or CO₂ fire extinguisher adjacent to the charging area.

9. No ignition sources

No person carrying out work in relation to a REFRIGERATING SYSTEM which involves exposing any pipe work shall use any sources of ignition in such a manner that it may lead to the risk of fire or explosion. All possible ignition sources, including cigarette smoking, should be kept sufficiently far away from the site of installation, repairing, removing and disposal, during which refrigerant can possibly be released to the surrounding space. Prior to work taking place, the area around the equipment is to be surveyed to make sure that there are no flammable hazards or ignition risks. "No Smoking" signs shall be displayed.

10. Ventilated area

Ensure that the area is in the open or that it is adequately ventilated before breaking into the system or conducting any hot work. A degree of ventilation shall continue during the period that the work is carried out. The ventilation should safely disperse any released refrigerant and preferably expel it externally into the atmosphere.

11. Checks to the refrigeration equipment

Where electrical components are being changed, they shall be fit for the purpose and to the correct specification. At all times the manufacturer's maintenance and service guidelines shall be followed. If in doubt consult the manufacturer's technical department for assistance. The following checks shall be applied to installations using FLAMMABLE REFRIGERANTS:

- the actual refrigerant charge is in accordance with the room size within which the refrigerant containing parts are installed;
- the ventilation machinery and outlets are operating adequately and are not obstructed;
- if an indirect refrigerating circuit is being used, the secondary circuits shall be checked for the presence of refrigerant;
- marking to the equipment continues to be visible and legible, marking and signs that are illegible shall be corrected;
- refrigeration pipe or components are installed in a position where they are unlikely to be exposed to any substance which may corrode refrigerant containing components, unless the components are constructed of materials which are inherently resistant to being corroded or are suitably protected against being so corroded.

12. Checks to electrical devices

Repair and maintenance to electrical components shall include initial safety checks and component inspection procedures. If a fault exists that could compromise safety, then no electrical supply shall be connected to the circuit until it is satisfactorily dealt with. If the fault cannot be corrected immediately but it is necessary to continue operation, and adequate temporary solution shall be used. This shall be reported to the owner of the equipment so all parties are advised.

Initial safety checks shall include:

- that capacitors are discharged: this shall be done in a safe manner to avoid possibility of sparking;
- that there no live electrical components and wiring are exposed while charging, recovering or purging the system;
- that there is continuity of earth bonding;
- Sealed electrical components shall be replaced if it's damage;
- Intrinsically safe components must be replaced if it's damage.

13. Cabling

Check that cabling will not be subject to wear, corrosion, excessive pressure, vibration, sharp edges or any other adverse environmental effects. The check shall also take into account the effects of aging or continual vibration from sources such as compressors or fans.

14. Detection of flammable refrigerants

Under no circumstances shall potential sources of ignition be used in the searching for or detection of refrigerant leaks. A halide torch (or any other detector using a naked flame) shall not be used.

The following leak detection methods are deemed acceptable for refrigerant systems. Electronic leak detectors may be used to detect refrigerant leaks but, in the case of FLAMMABLE REFRIGERANTS, the sensitivity may not be adequate, or may need re-calibration. (Detection equipment shall be calibrated in a refrigerant-free area.) Ensure that the detector is not a potential source of ignition and is suitable for the refrigerant used. Leak detection equipment shall be set at a percentage of the LFL of the refrigerant and shall be calibrated to the refrigerant employed, and the appropriate percentage of gas (25% maximum) is confirmed. Leak detection fluids are also suitable for use with most refrigerants but the use of detergents containing chlorine shall be avoided as the chlorine may react with the refrigerant and corrode the copper pipe-work.

NOTE Examples of leak detection fluids are

- bubble method,
- fluorescent method agents.

If a leak is suspected, all naked flames shall be removed/extinguished.

If a leakage of refrigerant is found which requires brazing, all of the refrigerant shall be recovered from the system, or isolated (by means of shut off valves) in a part of the system remote from the leak. See the following instructions of removal of refrigerant.

15. Removal and evacuation

When breaking into the refrigerant circuit to make repairs - or for any other purpose conventional procedures shall be used. However, for flammable refrigerants it is important that best practice be followed, since flammability is a consideration.

The following procedure shall be adhered to:

- safely remove refrigerant following local and national regulations;
- evacuate;
- purge the circuit with inert gas (optional for A2L);
- evacuate (optional for A2L);
- continuously flush or purge with inert gas when using flame to open circuit; and
- open the circuit.

The refrigerant charge shall be recovered into the correct recovery cylinders if venting is not allowed by local and national codes. For appliances containing flammable refrigerants, the system shall be purged with oxygen-free nitrogen to render the appliance safe for flammable refrigerants. This process might need to be repeated several times. Compressed air or oxygen shall not be used for purging refrigerant systems.

For appliances containing flammable refrigerants, refrigerants purging shall be achieved by breaking the vacuum in the system with oxygen-free nitrogen and continuing to fill until the working pressure is achieved, then venting to atmosphere, and finally pulling down to a vacuum (optional for A2L). This process shall be repeated until no refrigerant is within the system (optional for A2L). When the final oxygen-free nitrogen charge is used, the system shall be vented down to atmospheric pressure to enable work to take place.

The outlet for the vacuum pump shall not be close to any potential ignition sources, and ventilation shall be available.

16. Charging procedures

In addition to conventional charging procedures, the following requirements shall be followed:

Works shall be undertaken with appropriate tools only (In case of uncertainty, please consult the manufacturer of the tools for use with flammable refrigerants) Ensure that contamination of different refrigerants does not occur when using charging equipment. Hoses or lines shall be as short as possible to minimize the amount of refrigerant contained in them.

Cylinders shall be kept upright.

Ensure that the refrigeration system is earthed prior to charging the system with refrigerant.

Label the system when charging is complete (if not already).

Extreme care shall be taken not to overfill the refrigeration system.

Prior to recharging the system it shall be pressure tested with oxygen free nitrogen (OFN). The system shall be leak tested on completion of charging but prior to commissioning. A follow up leak test shall be carried out prior to leaving the site.

17. Decommissioning

Before carrying out this procedure, it is essential that the technician is completely familiar with the equipment and all its detail. It is recommended good practice that all refrigerants are recovered safely. Prior to the task being carried out, an oil and refrigerant sample shall be taken in case analysis is required prior to re-use of recovered refrigerant. It is essential that electrical power is available before the task is commenced.

a) Become familiar with the equipment and its operation.

b) Isolate system electrically

c) Before attempting the procedure ensure that:

- mechanical handling equipment is available, if required, for handling refrigerant cylinders;
- all personal protective equipment is available and being used correctly;
- the recovery process is supervised at all times by a competent person;
- recovery equipment and cylinders conform to the appropriate standards.

d) Pump down refrigerant system, if possible.

e) If a vacuum is not possible, make a manifold so that refrigerant can be removed from various parts of the system.

f) Make sure that cylinder is situated on the scales before recovery takes place.

g) Start the recovery machine and operate in accordance with instructions.

h) Do not overfill cylinders (no more than 80% volume liquid charge)

i) Do not exceed the maximum working pressure of the cylinder, even temporarily.

j) When the cylinders have been filled correctly and the process completed, make sure that the cylinders and the equipment are removed from site promptly and all isolation valves on the equipment are closed off.

k) Recovered refrigerant shall not be charged into another refrigeration system unless it has been cleaned and checked.

18. Labelling

Equipment shall be labelled stating that it has been de-commissioned and emptied of refrigerant. The label shall be dated and signed. For appliances containing FLAMMABLE REFRIGERANTS, ensure that there are labels on the equipment stating the equipment contains FLAMMABLE REFRIGERANT.

19. Recovery

When removing refrigerant from a system, either for servicing or decommissioning, it is recommended good practice that all refrigerants are removed safely.

When transferring refrigerant into cylinders, ensure that only appropriate refrigerant recovery cylinders are employed. Ensure that the correct number of cylinders for holding the total system charge is available. All cylinders to be used are designated for the recovered refrigerant and labelled for that refrigerant (i. e. special cylinders for the recovery of refrigerant). Cylinders shall be complete with pressure-relief valve and associated shut-off valves in good working order. Empty recovery cylinders are evacuated and, if possible, cooled before recovery occurs.

The recovery equipment shall be in good working order with a set of instructions concerning the equipment that is at hand and shall be suitable for the recovery of the flammable refrigerant. If in doubt, the manufacturer should be consulted. In addition, a set of calibrated weighing scales shall be available and in good working order. Hoses shall be complete with leak-free disconnect couplings and in good condition.

The recovered refrigerant shall be processed according to local legislation in the correct recovery cylinder, and the relevant waste transfer note arranged. Do not mix refrigerants in recovery units and especially not in cylinders.

If compressors or compressor oils are to be removed, ensure that they have been evacuated to an acceptable level to make certain that flammable refrigerant does not remain within the lubricant. The compressor body shall not be heated by an open flame or other ignition sources to accelerate this process. When oil is drained from a system, it shall be carried out safely.

20. Transportation, marking and storage for units that employ flammable refrigerants

a. General

The following information is provided for units that employ FLAMMABLE REFRIGERANTS.

b. Transport of equipment containing flammable refrigerants

Attention is drawn to the fact that additional transportation regulations may exist with respect to equipment containing flammable gas. The maximum number of pieces of equipment or the configuration of the equipment permitted to be transported together will be determined by the applicable transport regulations.

c. Marking of equipment using signs

Signs for similar appliances used in a work area are generally addressed by local regulations and give the minimum requirements for the provision of safety and/or health signs for a work location.

All required signs are to be maintained and employers should ensure that employees receive suitable and sufficient instruction and training on the meaning of appropriate safety signs and the actions that need to be taken in connection with these signs.

The effectiveness of signs should not be diminished by too many signs being placed together.

Any pictograms used should be as simple as possible and contain only essential details.

d. Disposal of equipment using flammable refrigerants

See national regulations.

e. Storage of equipment/appliances





The storage of the appliance should be in accordance with the applicable regulations or instructions, whichever is more stringent.

f. Storage of packed (unsold) equipment

Storage package protection should be constructed in such a way that mechanical damage to the equipment inside the package will not cause a leak of the REFRIGERANT CHARGE.

The maximum number of pieces of equipment permitted to be stored together will be determined by local regulations.



Explanation of symbols displayed on the indoor unit or outdoor unit

| | | |
|-----------------------------------------------------------------------------------|-----------------------|------------------------------------------------------------------------------------------------------------------------------------------------------------------------------|
|  | <p>WARNING</p> | <p>This symbol shows that this appliance used a flammable refrigerant. If the refrigerant is leaked and exposed to an external ignition source, there is a risk of fire.</p> |
|  | <p>CAUTION</p> | <p>This symbol shows that the operation manual should be read carefully.</p> |
|  | <p>CAUTION</p> | <p>This symbol shows that a service personnel should be handling this equipment with reference to the installation manual.</p> |
|  | <p>CAUTION</p> | |
|  | <p>CAUTION</p> | <p>This symbol shows that information is available such as the operating manual or installation manual.</p> |

ACCESSORIES

The air conditioning system comes with the following accessories. Use all of the installation parts and accessories to install the air conditioner. Improper installation may result in water leakage, electrical shock and fire, or equipment failure.

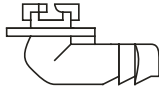
Accessories (Packed with the outdoor unit)

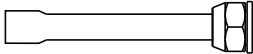
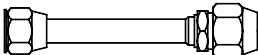
| Name | Shape | Quantity |
|-----------------------------------------------------------------------------------------------------|-------------------------------------------------------------------------------------|----------|
| Drain joint |  | 1 |
| Seal ring (Not available for the outdoor unit with dimensions of 38-19/32in*38-3/8in*16-11/32in) |  | 1 |
| Flare-to-braze adapter |  | 2 |
| 5/8 flare→3/4 flare adapter (For 18K Regular Heat Series & AC Cooling Only) |  | 1 |

REFRIGERANT PIPING CONNECTION

Safety Precautions

WARNING

- All field piping must be completed by a licensed technician and must comply with the local and national regulations.
- When the air conditioner is installed in a small room, measures must be taken to prevent the refrigerant concentration in the room from exceeding the safety limit in the event of refrigerant leakage. If the refrigerant leaks and its concentration exceeds its proper limit, hazards due to lack of oxygen may result.
- When installing the refrigeration system, ensure that air, dust, moisture or foreign substances do not enter the refrigerant circuit. Contamination in the system may cause poor operating capacity, high pressure in the refrigeration cycle, explosion or injury.
- Ventilate the area immediately if there is refrigerant leakage during the installation. Leaked refrigerant gas is both toxic and flammable. Ensure there is no refrigerant leakage after completing the installation work.

Notes on pipe length and elevation

Ensure that the length of the refrigerant pipe, the number of bends, and the drop height between the indoor and outdoor units meets the requirements shown in the following table:

The Maximum Length And Drop Height Based on Models.

| Model | Length of piping | Maximum drop height |
|-----------------|------------------|---------------------|
| 18K | 98.4ft/30m | 65.6ft/20m |
| 24K/30K | 164ft/50m | 82ft/25m |
| 36K/48K/54K/60K | 246ft/75m | 98.4ft/30m |

CAUTION

Oil traps

If oil flows back into the outdoor unit's compressor, this might cause liquid compression or deterioration of oil return. Oil traps in the rising gas piping can prevent this.

An oil trap should be installed every 20ft (6m) of vertical suction line riser (<36000Btu/h unit).

An oil trap should be installed every 32.8ft (10m) of vertical suction line riser (≥36000Btu/h unit).

| Name | Model | Pipe specification | | Remark |
|--------------------------|-------|--------------------|----------------|---------------------------------------------------------------------------------------------------------|
| | | Liquid Side | Gas Side | |
| Connecting pipe assembly | 18K | ø3/8in (ø9.52mm) | ø3/4in (ø19mm) | Pipes are not included in the accessories and you need to purchase it separately from the local dealer. |
| | 24K | ø3/8in (ø9.52mm) | ø3/4in (ø19mm) | |
| | 30K | ø3/8in (ø9.52mm) | ø3/4in (ø19mm) | |
| | 36K | ø3/8in (ø9.52mm) | ø3/4in (ø19mm) | |
| | 48K | ø3/8in (ø9.52mm) | ø3/4in (ø19mm) | |
| | 54K | ø3/8in (ø9.52mm) | ø3/4in (ø19mm) | |
| | 60K | ø3/8in (ø9.52mm) | ø3/4in (ø19mm) | |

| Air Handler Unit Model | Air Handler Unit Connection (in. flare) | | Adapter Required at Air Handler Unit (in. flare to braze) | Outdoor Model | Outdoor Unit Connection (in. flare) | | Adapter Required at Outdoor Unit (in. flare to flare or braze) |
|------------------------|-----------------------------------------|-----|-----------------------------------------------------------|----------------------------------------------|-------------------------------------|-----|----------------------------------------------------------------|
| | Liquid | Gas | | | Liquid | Gas | |
| 18K-60K | Liquid | 3/8 | 3/8 flare→3/8 braze | 18K (Std. Heat & AC Cooling Only) | Liquid | 3/8 | 3/8 flare→3/8 braze |
| | | | | | Gas | 5/8 | 5/8 flare→3/4 braze 5/8 flare→3/4 braze |
| | Gas | 3/4 | 3/4 flare→3/4 braze | 18K (Hyper Heat)/ 24K/30K/36K/ 48K/60K | Liquid | 3/8 | 3/8 flare→3/8 braze |
| | | | | | Gas | 3/4 | 3/4 flare→3/4 braze |

Connection Instructions—Refrigerant Piping

CAUTION

- The branching pipe must be installed horizontally. An angle of more than 10° may cause malfunction.
- **DO NOT** install the connecting pipe until both indoor and outdoor units have been installed.
- Insulate both the gas and liquid piping to prevent condensation.

Step 1: Cut pipes

When preparing refrigerant pipes, take extra care to cut and flare them properly. This will ensure efficient operation and minimize the need for future maintenance.

- Measure the distance between the indoor and outdoor units.
- Using a pipe cutter, cut the pipe a little longer than the measured distance.
- Make sure that the pipe is cut at a perfect 90° angle.

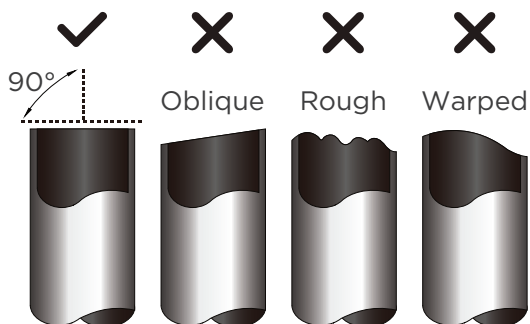

DO NOT DEFORM PIPE WHILE CUTTING

Be extra careful not to damage, dent, or deform the pipe while cutting. This will drastically reduce the heating

Step 2: Remove burrs

Burrs can affect the air-tight seal of refrigerant piping connection. They must be completely removed.

- Hold the pipe at a downward angle to prevent burrs from falling into the pipe.
- Using a reamer or deburring tool, remove all burrs from the cut section of the pipe.

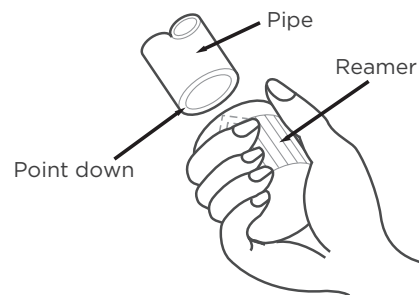

Step 3: Flare pipe ends

Proper flaring is essential to achieve an airtight seal.

- After removing burrs from cut pipe, seal the ends with PVC tape to prevent foreign materials from entering the pipe.
- Sheath the pipe with insulating material.
- Place flare nuts on both ends of pipe. Make sure they are facing in the right direction, because you can't put them on or change their direction after flaring.

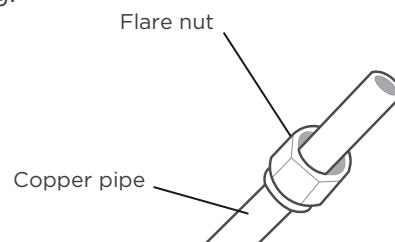

- Remove PVC tape from ends of pipe when ready to perform flaring work.

- Clamp flare form on the end of the pipe. The end of the pipe must extend beyond the flare form.

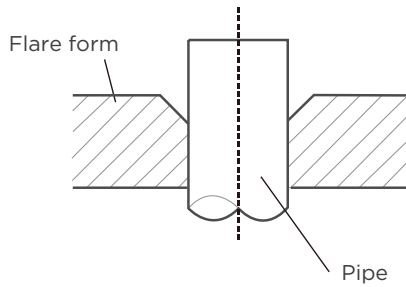

- Place flaring tool onto the form.
- Turn the handle of the flaring tool clockwise until the pipe is fully flared.

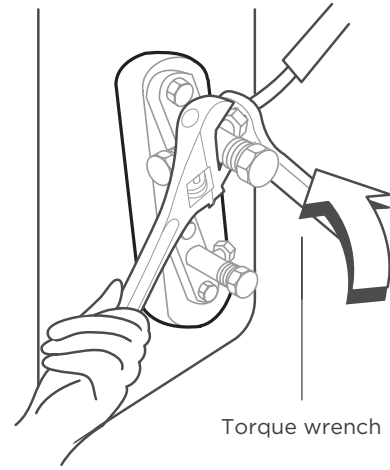

PIPING EXTENSION BEYOND FLARE FORM

| Pipe gauge | Tightening torque | Flare dimension (A) | | Flare shape |
|---------------------|--------------------------------|---------------------|--------------------|-------------|
| | | Min. | Max. | |
| Ø3/8in (Ø9.52mm) | 32-39 N·m (320-390kgf·cm) | 0.52in (13.2mm) | 0.53in (13.5mm) | |
| Ø5/8in (Ø16mm) | 57-71 N·m (570-710kgf·cm) | 0.76in (19.2mm) | 0.78in (19.7mm) | |
| Ø3/4in (Ø19mm) | 67-101 N·m (670-1010kgf·cm) | 0.91in (23.2mm) | 0.93in (23.7mm) | |

- Remove the flaring tool and flare form, then inspect the end of the pipe for cracks and even flaring.

Step 4: Connect pipes

Connect the copper pipes to the indoor unit first, then connect it to the outdoor unit. You should first connect the low-pressure pipe, then the high-pressure pipe.

- When connecting the flare nuts, apply a thin coat of refrigeration oil to the flared ends of the pipes.
- Align the center of the two pipes that you will connect.
- Tighten the flare nut snugly by hand.
- Using a wrench, grip the nut on the unit tubing.
- While firmly gripping the nut, use a torque wrench to tighten the flare nut according to the torque values in above table.

NOTICE

Use both a spanner and a torque wrench when connecting or disconnecting pipes to/from the unit.

CAUTION

Ensure to wrap insulation around the piping. Direct contact with the bare piping may result in burns or frostbite.

- Make sure the pipe is properly connected. Over tightening may damage the bell mouth and under tightening may lead to leakage.

NOTICE

MINIMUM BEND RADIUS

Carefully bend the tubing in the middle according to the diagram below.

DO NOT bend the tubing more than 90° or more than 3 times.

Use care when bending pipe, do not kink pipe.

Use appropriate tool

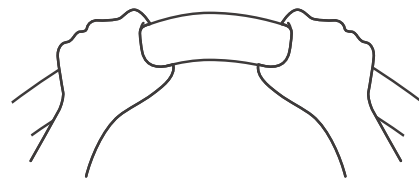

min-radius 3.9in (100mm)

- After connecting the copper pipes to the indoor unit, wrap the power cable, signal cable and the piping together with binding tape.

NOTICE

DO NOT intertwine signal cable with other wires. While bundling these items together. **DO NOT** intertwine or cross the signal cable with any other wiring.

OUTDOOR UNIT INSTALLATION

NOTICE

Install the unit by following local switches and regulations, there may be differ slightly between different regions.

Select the installation location of outdoor units

Before installing the outdoor unit, you must choose an appropriate location. The following are standards that will help you choose an appropriate location for the unit.

Proper installation locations meet the following standards:



- ✓ Firm and solid—the location can support the unit and will not vibrate.



- ✓ Noise from the unit will not disturb other people.



- ✓ Good air circulation and ventilation.

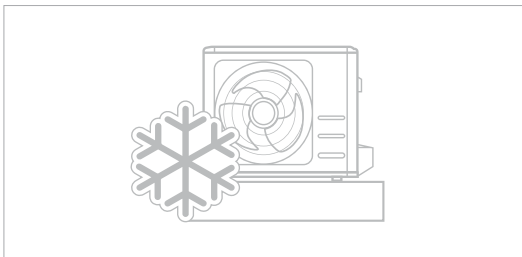

- ✓ Where snowfall is anticipated, take appropriate measures to prevent ice buildup and coil damage.

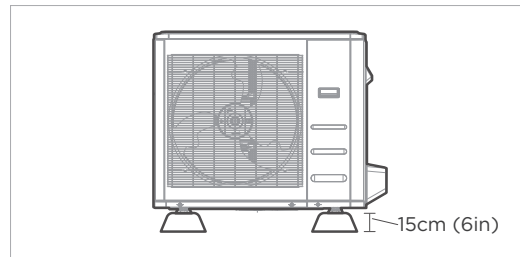

- ✓ The outdoor unit must be installed on risers of at least 15cm (6in) in height or per local code to get unit above local mean snow fall.

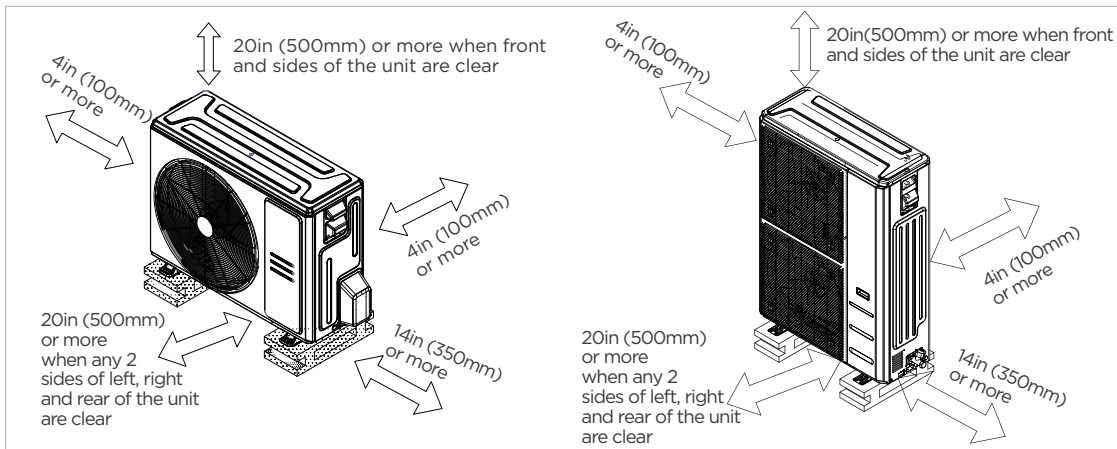

- ✓ Meets all spatial requirements shown in Installation Space Requirements above.

DO NOT install unit in the following locations:

- ⊘ Near an obstacle that will block air inlets and outlets.
- ⊘ In a location that is exposed to large amounts of dust.
- ⊘ Near animals or plants that will be harmed by hot air discharge.
- ⊘ Near any source of combustible gas
- ⊘ Near a public street, crowded areas, or where noise from the unit will disturb others.

⚠ CAUTION:

SPECIAL CONSIDERATIONS FOR EXTREME WEATHER

If the unit is exposed to heavy wind:

Install unit so that air outlet fan is at a 90° angle to the direction of the wind. If needed, build a barrier in front of the unit to protect it from extremely heavy winds. See Figures below.

If the unit is frequently exposed to heavy rain or snow:

Build a shelter above the unit to protect it from the rain or snow. Be careful not to obstruct air flow around the unit.

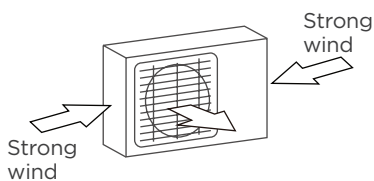

90° angle to the direction of the wind

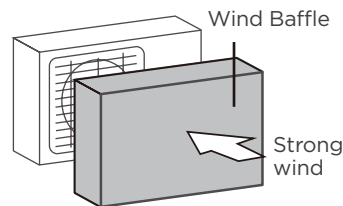

Build a wind Baffle to protect the unit

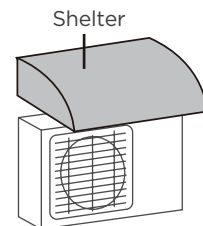

Build a shelter to protect the unit

Install drain joint (Heat pump unit only)

Before bolting the outdoor unit in place, you must install the drain joint at the bottom of the unit.

Note that there are two different types of drain joints depending on the type of outdoor unit.

If the drain joint comes with a rubber seal (see Fig. A), do the following:

1. Fit the rubber seal on the end of the drain joint that will connect to the outdoor unit.
2. Insert the drain joint into the hole in the base pan of the unit.
3. Rotate the drain joint 90° until it clicks in place facing the front of the unit.
4. Connect a drain hose extension (not included) to the drain joint to redirect water from the unit during heating mode.

If the drain joint doesn't come with a rubber seal (see Fig. B), do the following:

1. Insert the drain joint into the hole on the base pan, press firmly to ensure it is properly installed and will not become loose.
2. Connect a drain hose extension (not included) to the drain joint to redirect water from the unit during heating mode.

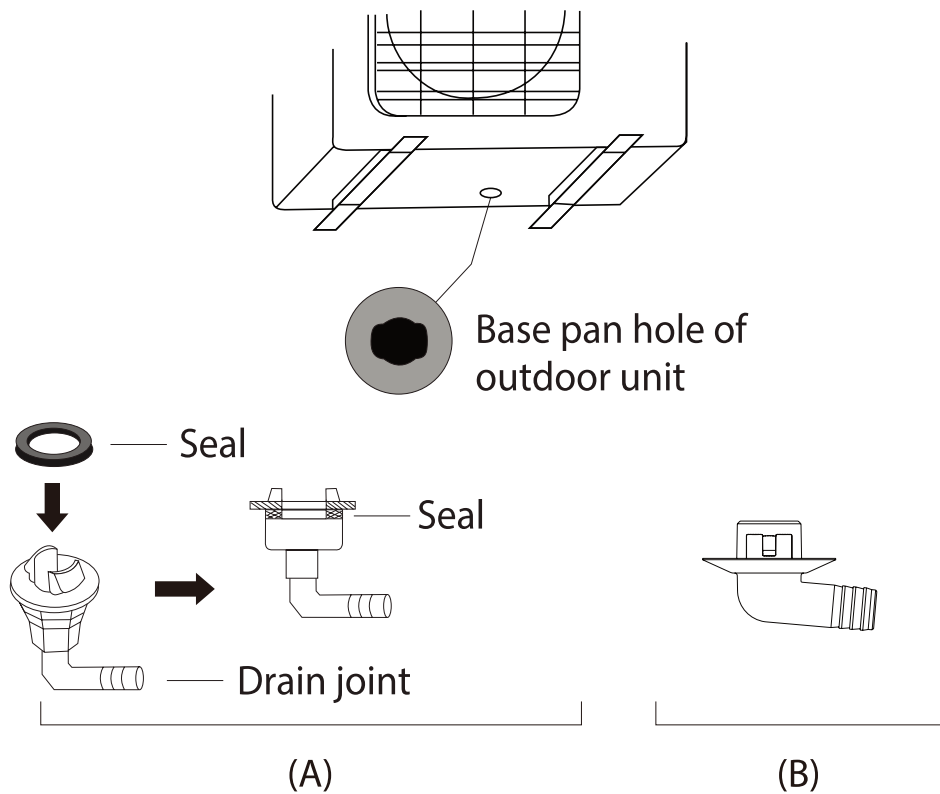

! IN COLD CLIMATES

In cold climates, make sure that the drain hose is as vertical as possible to ensure swift water drainage. If water drains too slowly, it can freeze in the hose and flood the unit.

Anchor outdoor unit

The outdoor unit can be anchored to the ground or to a wall-mounted bracket with bolt (M10). Prepare the installation base of the unit according to the dimensions below.

Outdoor Unit Types and Specifications

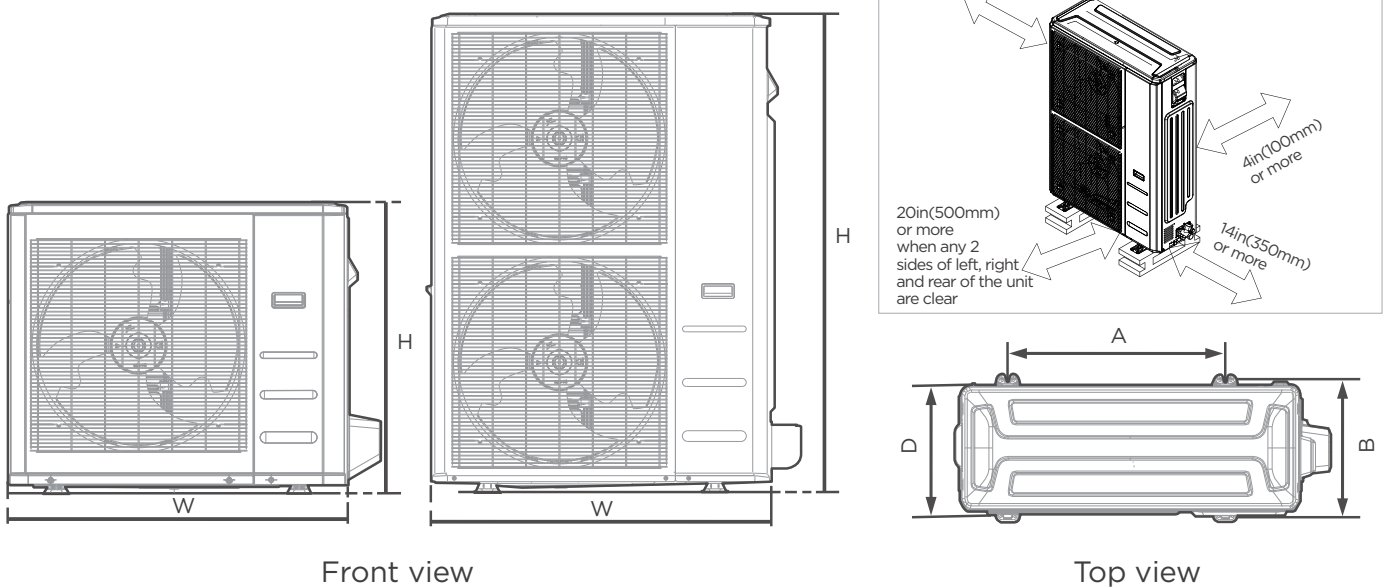

| Outdoor Unit Dimensions | | | | | | Mounting Dimensions | | | |
|-------------------------|-----|----------|------|----------|-----|---------------------|-----|----------|-----|
| W | | H | | D | | A | | B | |
| inch | mm | inch | mm | inch | mm | inch | mm | inch | mm |
| 31-11/16 | 805 | 21-13/16 | 554 | 13 | 330 | 20-1/8 | 511 | 12-1/2 | 317 |
| 35 | 890 | 26-1/2 | 673 | 13-15/32 | 342 | 26-1/8 | 663 | 13-15/16 | 354 |
| 37-1/4 | 946 | 31-29/32 | 810 | 16-5/32 | 410 | 26-1/2 | 673 | 15-7/8 | 403 |
| 38-19/32 | 980 | 38-3/8 | 975 | 16-11/32 | 415 | 24-1/4 | 616 | 15-5/8 | 397 |
| 37-1/2 | 952 | 52-1/2 | 1333 | 16-11/32 | 415 | 24-35/36 | 634 | 15-29/32 | 404 |

(unit: inch/mm)

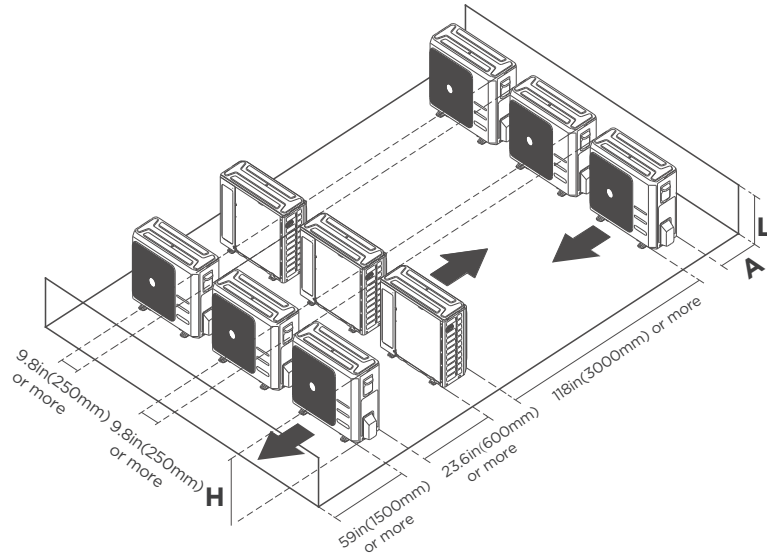

Rows of series installation

The relations between H, A and L are as follows.

| | L | A |
|-------|---------------------|----------------------------|
| L ≤ H | $L \leq 1/2H$ | 9-13/16in (250mm) or more |
| | $1/2H < L \leq H$ | 11-13/16in (300mm) or more |
| L > H | Cannot be installed | |

If you will install the unit on the ground or on a concrete mounting platform, DO THE FOLLOWING:

- Mark the positions for four expansion bolts based on dimensions chart.
- Pre-drill holes for expansion bolts.
- Place a nut on the end of each expansion bolt.
- Hammer expansion bolts into the pre-drilled holes.
- Remove the nuts from expansion bolts, and place outdoor unit on bolts.
- Put washer on each expansion bolt, then replace the nuts.
- Using a wrench, tighten each nut until snug.

⚠ WARNING

WHEN DRILLING INTO CONCRETE, EYE PROTECTION IS RECOMMENDED AT ALL TIMES.

If you will install the unit on a wall-mounted bracket, DO THE FOLLOWING:

- Mark the position of bracket holes based on dimensions chart.
- Pre-drill the holes for the expansion bolts.
- Place a washer and nut on the end of each expansion bolt.
- Thread expansion bolts through holes in mounting brackets, put mounting brackets in position, and hammer expansion bolts into the wall.
- Check that the mounting brackets are level.
- Carefully lift unit and place its mounting feet on brackets.
- Bolt the unit firmly to the brackets.
- If allowed, install the unit with rubber isolator pads to reduce vibrations and noise.

⚠ CAUTION

Make sure that the wall is made of solid brick, concrete, or of similarly strong material. The wall must be able to support at least four times the weight of the unit.

WIRING PRECAUTIONS

WARNING

BEFORE PERFORMING ANY ELECTRICAL WORK, READ THESE WARNINGS.

- All wiring must comply with local and national electrical codes, regulations and must be installed by a licensed electrician.
- All electrical connections must be made according to the Electrical Connection Diagram located on the panels of the indoor and outdoor units.
- If there is a serious safety issue with the power supply, stop work immediately. Explain your reasoning to the client, and refuse to install the unit until the safety issue is properly resolved.
- Power voltage should be within 90-110% of rated voltage. Insufficient power supply can cause malfunction, electrical shock, or fire.
- Installation of an external surge suppressor at the outdoor disconnect is recommended.
- Power must be connected, a switch or circuit breaker that disconnects all poles and has a contact separation of at least 1/8in (3mm) must be incorporated in the fixed wiring. The qualified technician must use an approved circuit breaker or switch.
- Only connect the unit to an individual branch circuit. Do not connect another appliance to that circuit.
- Make sure to properly ground the air conditioner.
- Every wire must be firmly connected. Loose wiring can cause the terminal to overheat, resulting in product malfunction and possible fire.
- Do not let wires touch or rest against refrigerant tubing, the compressor, or any moving parts within the unit.
- To avoid getting an electric shock, never touch the electrical components soon after the power supply has been turned off. After turning off the power, always wait 10 minutes or more before you touch the electrical components.
- Make sure that you do not cross your electrical wiring with your signal wiring. This may cause distortion, interference or possibly damage to circuit boards.
- Connect the outdoor wires before connecting the indoor wires.

WARNING

BEFORE PERFORMING ANY ELECTRICAL OR WIRING WORK, TURN OFF THE MAIN POWER TO THE SYSTEM.

OUTDOOR UNIT WIRING

⚠ WARNING

Before performing any electrical or wiring work, turn off the main power to the system.

Step 1: Prepare the cable for connection.

1. You must first choose the right cable size.
2. Using wire strippers, strip the jacket from both ends of the signal cable to reveal approximately 5.9in (150mm) of wire.
3. Strip the insulation from the ends.
4. Stranded wire requires u-lugs or ring terminals to be crimped onto the ends of the wire.

💡 NOTICE

- When connecting the wires, strictly follow the wiring diagram found inside the electrical box cover.
- Choose the cable type according to the local electrical switches and regulations.
- Please choose the right cable size according to the Minimum Circuit Ampacity indicated on the name plate of the unit.

Step 2: Remove the electric cover.

Remove the electric cover of the outdoor unit.

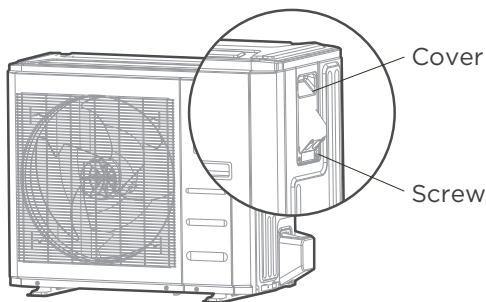

Step 3: Connect the u-lugs to the terminals

Match the wire colors/labels with the labels on the terminal block. Firmly screw the u-lug of each wire to its corresponding terminal.

Outdoor Unit A

Cooling only

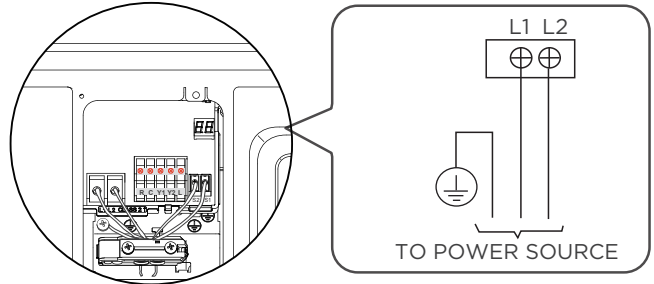

Other

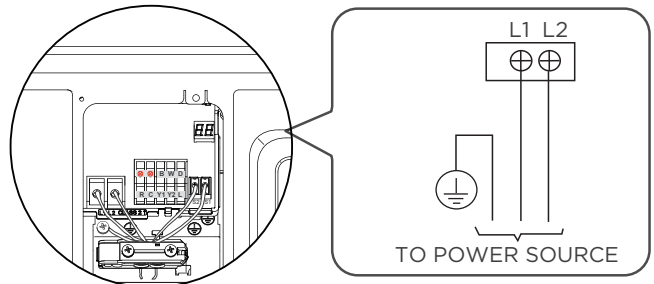

Outdoor Unit B

Cooling only

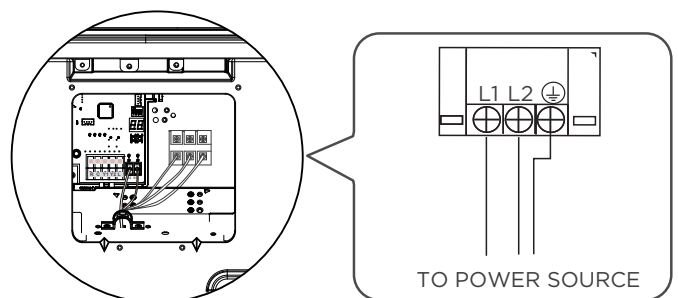

Other

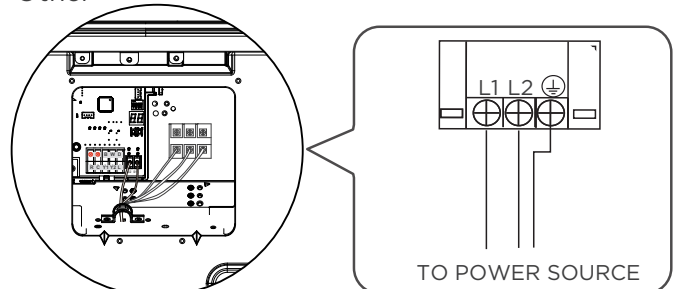

4. Clamp down the cable with the cable clamp.
5. Insulate unused wires with electrical tape.
Keep them away from any electrical or metal parts.
6. Reinstall the cover of the electric control box.

In North America

1. Remove the wire cover from the unit by loosening the 3 screws.
2. Remove caps on the conduit panel.
3. Mount the conduit tubes (not included) on the caonduit panel.
4. Properly connect both the power supply and low voltage lines to the corresponding terminals on the terminal block.
5. Ground the unit in accordance with local codes.
6. Be sure to size each wire allowing several inches longer than the required length for wiring.

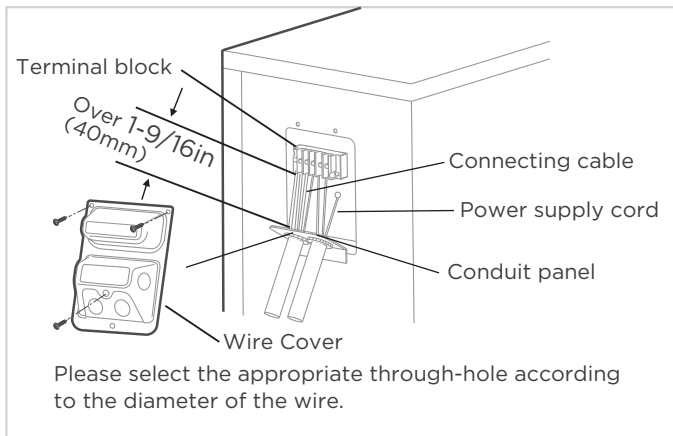

⚠ WARNING

ISOLATE THE POWER SUPPLY LEADS AND COMMUNICATION LEADS BY THE STRAIN RELIF AND KEEP POWER SUPPLY LEADS AWAY FROM COMMUNICATION LEADS.

SPECIFIC WIRING METHODS

⚠ WARNING

Please refer to the wiring nameplate for the wiring method. Do not connect 24V AC to S1 - S2, as this will damage the system.

Connection method A:

This is the preferred method of control with the communicating control, ACiQ indoor and outdoor unit. Refer to the wiring method of internal and external machine communication and wired controller as follows:

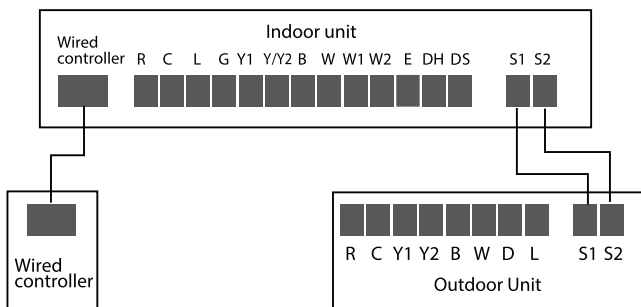

Connection method B:

To use a 24V thermostat, you need to refer to the following wiring:

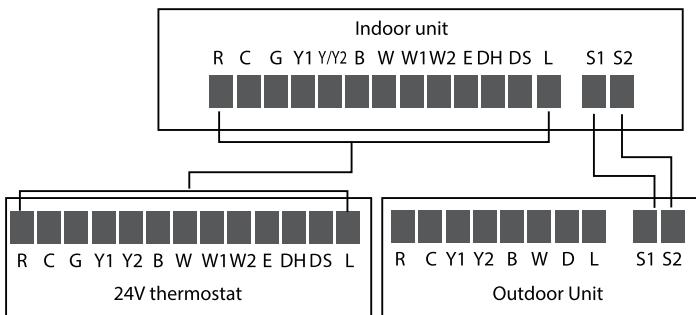

When using a 24V thermostat, please refer to the non-communicating wiring diagrams that follow:

Connection method C:

💡 NOTICE

This equipment uses B functionality. This terminal is energized for heating functionality. Please ensure that thermostat configuration is set up for B functionality.
Note: These methods are for use with a ACiQ outdoor unit and a third party indoor unit or cased coil and gas furnace.

24V communication

Cooling only

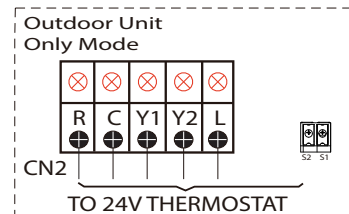

Other

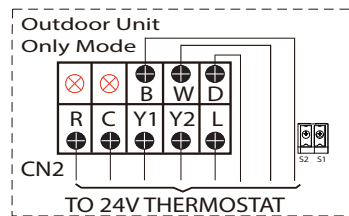

24V must never be connected to S1 - S2. All wiring must be in compliance with the above scenarios. Incorrect wiring will cause irreversible damage to control.

💡 NOTICE

The use of shielded communication or thermostat wire is not required, but is recommended where separation from high voltage conductors cannot be maintained, or in areas with high electrical noise. The shield and drain conductor must be grounded at the outdoor unit and stripped back and taped at the indoor unit. Grounding at both ends results in an increase of noise transmitted onto the signal wires.

Outdoor unit DIP Switch setting

Press the SW4 button 10S for force defrosting

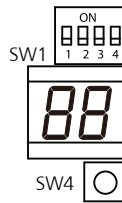

Cooling only

| NO. | Dial code | Features | ON | OFF |
|-----|-----------|--------------------------------------|-----------------------------------------------------------------|-------------------------------------------------------------------|
| 1 | SW1-1 | Function to be defined | | |
| 2 | SW1-2 | Communication dial code | 24V communication only | 24V communication/ 485 communication |
| 3 | SW1-3 | Strong cold and strong heat function | The cooling/heating target pressure compensation value is valid | The cooling/heating target pressure compensation value is invalid |
| 4 | SW1-4 | Enhanced defrosting function | none | none |

Other

| NO. | Dial code | Features | ON | OFF |
|-----|-----------|--------------------------------------|-----------------------------------------------------------------|-------------------------------------------------------------------|
| 1 | SW1-1 | Function to be defined | | |
| 2 | SW1-2 | Communication dial code | 24V communication only | 24V communication/ 485 communication |
| 3 | SW1-3 | Strong cold and strong heat function | The cooling/heating target pressure compensation value is valid | The cooling/heating target pressure compensation value is invalid |
| 4 | SW1-4 | Enhanced defrosting function | Enhanced defrosting | Default setting (standard defrost algorithm) |

SPECIFIC WIRING METHODS

NOTICE

The following wiring diagram are suitable for the AHU and ODU with 24V thermostat.

Non-communication scheme wiring reference

• Wiring for 4H and 2C thermostat

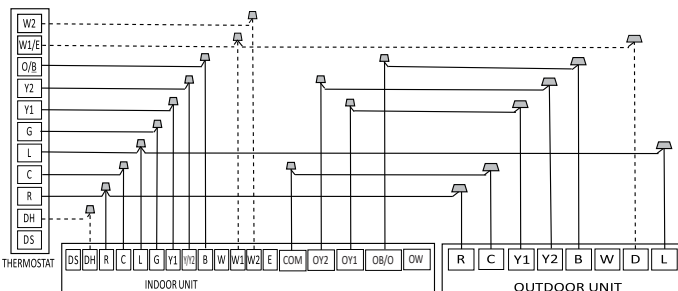

S4-2 Default on, DH function off. Turn switch off to activate DH function.

S4-4 Default on, W1 and W2 shorted for single stage Aux heat operation. Turn off to separate stages.

• Wiring for 3H and 2C thermostat

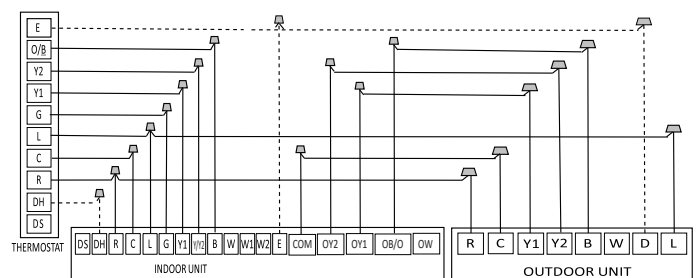

S4-2 Default on, DH function off. Turn switch off to activate DH function.

Emergency heating control two groups of electric heating at the same time

• Wiring for 3H and 1C thermostat

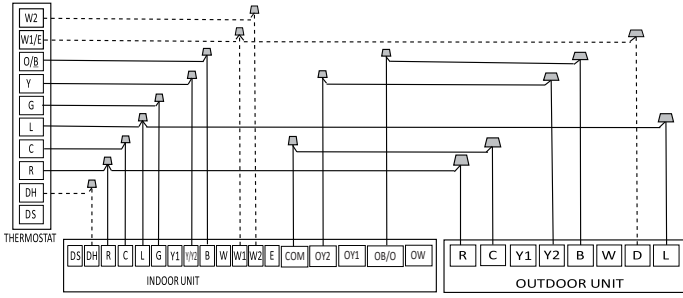

S4-2 Default on, DH function off. Turn switch off to activate DH function.

S4-4 Default on, W1 and W2 shorted for single stage Aux heat operation. Turn off to separate stages.

• Wiring for 2H and 2C thermostat

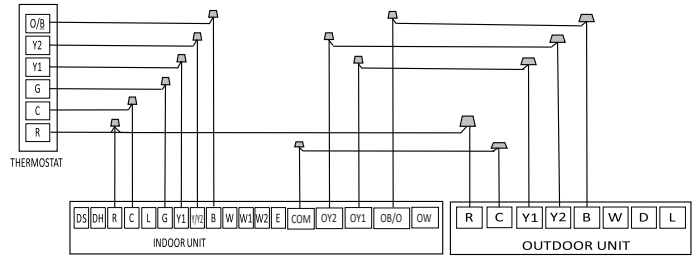

• Wiring for 3H and 2C thermostat

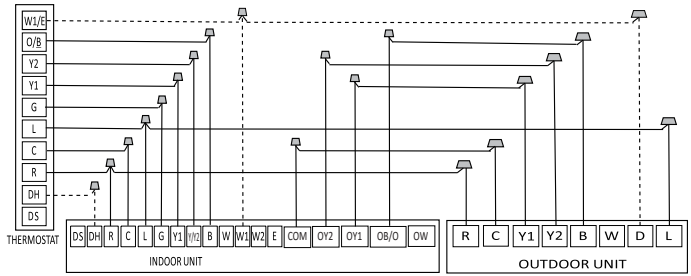

S4-2 Default on, DH function off. Turn switch off to activate DH function.

S4-4 Default on, W1 and W2 shorted for single stage Aux heat operation. Turn off to separate stages.

• Wiring for 2H and 1C thermostat

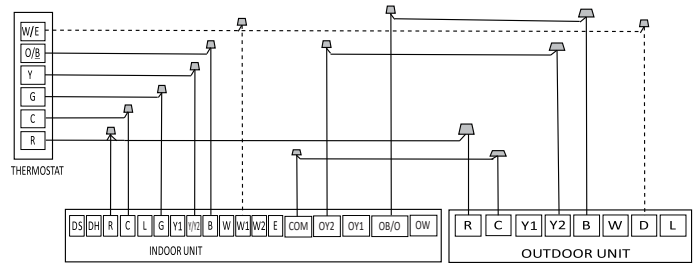

S4-4 Default on, W1 and W2 shorted for single stage Aux heat operation. Turn off to separate stages.

• Wiring for 1H and 1C thermostat

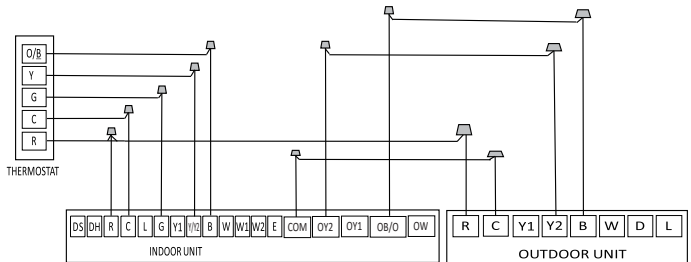

• Wiring for 1H and 1C thermostat

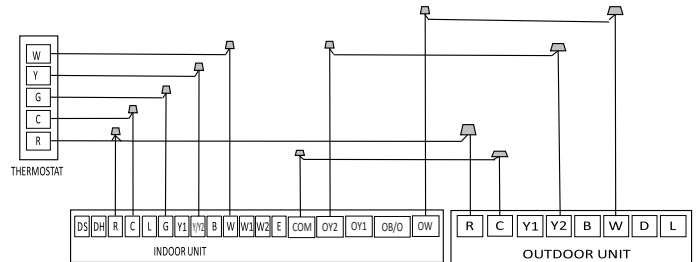

NOTICE

This is the least preferred method of control wiring and should only be used for emergency situations. Full comfort capacity may not be achieved using this method.

Control logic

Indoor unit connector

| Connector | Purpose |
|-----------|-------------------------|
| R | 24V power Connection |
| C | Common |
| Y1 | Low Cooling |
| Y2 | High Cooling |
| B | Heating Reversing Valve |
| W | Heating control |
| D | Defrost control |
| L | System Fault Signal |

LED display

The control displays unit status as well as any active fault codes on the LED display. If the unit is functioning normally, the LED will display current temperature setpoint. When a fault code is active, the display will flash the active fault code. Please refer to the fault code table located in the troubleshooting section of the Service Manual for detailed fault code information.

SPECIFICATIONS

Cooling and Heating power specifications (Standard Heat Series)

| MODEL (Btu/h) | | 18K | 24K | 30K | |
|-----------------|----------------------------|---------------------|----------|-----|----|
| POWER (outdoor) | PHASE | 1 Phase | | | |
| | FREQUENCY AND VOLT | 208/230V,60Hz | | | |
| OUTDOOR UNIT | MCA | 16A | 19A | 23A | |
| | MOP | 20A | 20A | 25A | |
| LINES GAUGE | OUTDOOR UNIT POWER LINE | LINE QUANTITY | 2+Ground | | |
| | | LINE DIAMETER (AWG) | 14 | 12 | 12 |
| | OUTDOOR-INDOOR SIGNAL LINE | LINE QUANTITY | 2 | | |
| | | LINE DIAMETER (AWG) | 20 | | |
| | THERMOSTAT SIGNAL LINE | LINE QUANTITY | --- | | |
| | | LINE DIAMETER (AWG) | 18 | | |

| MODEL (Btu/h) | | 36K | 48K | 60K | |
|-----------------|----------------------------|---------------------|----------|-----|---|
| POWER (outdoor) | PHASE | 1 Phase | | | |
| | FREQUENCY AND VOLT | 208/230V,60Hz | | | |
| OUTDOOR UNIT | MCA | 27A | 36A | 39A | |
| | MOP | 30A | 40A | 40A | |
| LINES GAUGE | OUTDOOR UNIT POWER LINE | LINE QUANTITY | 2+Ground | | |
| | | LINE DIAMETER (AWG) | 10 | 8 | 8 |
| | OUTDOOR-INDOOR SIGNAL LINE | LINE QUANTITY | 2 | | |
| | | LINE DIAMETER (AWG) | 20 | | |
| | THERMOSTAT SIGNAL LINE | LINE QUANTITY | --- | | |
| | | LINE DIAMETER (AWG) | 18 | | |

NOTICE

Line Diameter Sizing per NFPA 70 (2020), Table 310.15 (B) (16) Based on type NM-B Romex wire. Other sizing options are possible. Consult NFPA 70 or Licensed Electrician for alternate sizing.

Cooling and Heating power specifications (Extreme Heat Series)

| MODEL (Btu/h) | | 18K | 24K | 30K | |
|-----------------|----------------------------|---------------------|----------|-------|----|
| POWER (outdoor) | PHASE | 1 Phase | | | |
| | FREQUENCY AND VOLT | 208/230V,60Hz | | | |
| OUTDOOR UNIT | MCA | 17A | 19A | 29.5A | |
| | MOP | 20A | 20A | 30A | |
| LINES GAUGE | OUTDOOR UNIT POWER LINE | LINE QUANTITY | 2+Ground | | |
| | | LINE DIAMETER(AWG) | 12 | 12 | 10 |
| | OUTDOOR-INDOOR SIGNAL LINE | LINE QUANTITY | 2 | | |
| | | LINE DIAMETER (AWG) | 20 | | |
| | THERMOSTAT SIGNAL LINE | LINE QUANTITY | --- | | |
| | | LINE DIAMETER (AWG) | 18 | | |

| MODEL (Btu/h) | | 36K | | 48K | 60K | |
|-----------------|----------------------------|---------------------|----------|-----|-----|---|
| POWER (outdoor) | PHASE | 1 Phase | | | | |
| | FREQUENCY AND VOLT | 208/230V,60Hz | | | | |
| OUTDOOR UNIT | MCA | 32A | 30A | 38A | 40A | |
| | MOP | 35A | 30A | 40A | 40A | |
| LINES GAUGE | OUTDOOR UNIT POWER LINE | LINE QUANTITY | 2+Ground | | | |
| | | LINE DIAMETER (AWG) | 10 | 10 | 8 | 8 |
| | OUTDOOR-INDOOR SIGNAL LINE | LINE QUANTITY | 2 | | | |
| | | LINE DIAMETER (AWG) | 20 | | | |
| | THERMOSTAT SIGNAL LINE | LINE QUANTITY | --- | | | |
| | | LINE DIAMETER (AWG) | 18 | | | |

NOTICE

Line Diameter Sizing per NFPA 70 (2020), Table 310.15 (B) (16) Based on type NM-B Romex wire. Other sizing options are possible. Consult NFPA 70 or Licensed Electrician for alternate sizing.

AC-Cooling Only Series power specifications

| MODEL (Btu/h) | | 18K | 24K | 30K | |
|-----------------|----------------------------|---------------------|----------|-----|----|
| POWER (outdoor) | PHASE | 1 Phase | | | |
| | FREQUENCY AND VOLT | 208/230V,60Hz | | | |
| OUTDOOR UNIT | MCA | 16A | 19A | 20A | |
| | MOP | 20A | 20A | 20A | |
| LINES GAUGE | OUTDOOR UNIT POWER LINE | LINE QUANTITY | 2+Ground | | |
| | | LINE DIAMETER(AWG) | 14 | 12 | 12 |
| | OUTDOOR-INDOOR SIGNAL LINE | LINE QUANTITY | 2 | | |
| | | LINE DIAMETER (AWG) | 20 | | |
| | THERMOSTAT SIGNAL LINE | LINE QUANTITY | --- | | |
| | | LINE DIAMETER (AWG) | 18 | | |

| MODEL (Btu/h) | | 36K | 48K/54K | 60K | |
|-----------------|----------------------------|---------------------|----------|-----|---|
| POWER (outdoor) | PHASE | 1 Phase | | | |
| | FREQUENCY AND VOLT | 208/230V,60Hz | | | |
| OUTDOOR UNIT | MCA | 25A | 36A | 37A | |
| | MOP | 25A | 40A | 40A | |
| LINES GAUGE | OUTDOOR UNIT POWER LINE | LINE QUANTITY | 2+Ground | | |
| | | LINE DIAMETER (AWG) | 10 | 8 | 8 |
| | OUTDOOR-INDOOR SIGNAL LINE | LINE QUANTITY | 2 | | |
| | | LINE DIAMETER (AWG) | 20 | | |
| | THERMOSTAT SIGNAL LINE | LINE QUANTITY | --- | | |
| | | LINE DIAMETER (AWG) | 18 | | |

NOTICE

Line Diameter Sizing per NFPA 70 (2020), Table 310.15 (B) (16) Based on type NM-B Romex wire. Other sizing options are possible. Consult NFPA 70 or Licensed Electrician for alternate sizing.

AIR EVACUATION

NOTICE

When opening valve stems, turn the hexagonal wrench until it hits against the stopper. Do not try to force the valve to open further.

Open valves slowly until you hear refrigerant, allow pressure to equalize before opening fully. Open large vapor line valve first.

Preparations and precautions

Air and foreign matter in the refrigerant circuit can cause abnormal rises in pressure, which can damage the air conditioner, reduce its efficiency, and cause injury. Use a vacuum pump and manifold gauge to evacuate the refrigerant circuit, removing any non-condensable gas and moisture from the system. Evacuation should be performed upon initial installation and when unit is relocated.

BEFORE PERFORMING EVACUATION

- ✔ Check to make sure the connective pipes between the indoor and outdoor units are connected properly.
- ✔ Check to make sure all wiring is connected properly.

Evacuation Instructions

1. Connect the charge hose of the manifold gauge to service port on the outdoor unit's low-pressure valve.
2. Connect another charge hose from the manifold gauge to the vacuum pump.
3. Open the Low-Pressure side of the manifold gauge. Keep the High-Pressure side closed.
4. Tighten refrigerant valve caps hand tight plus flat to ensure there are no vacuum leaks.
5. Turn on the vacuum pump to evacuate the system.

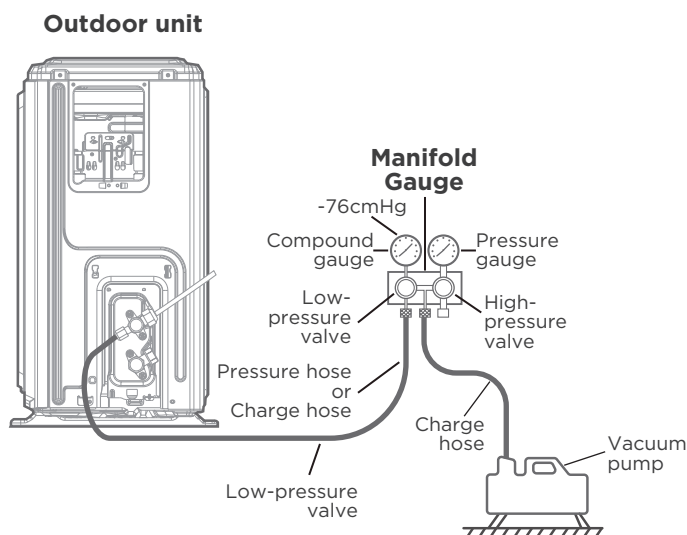

6. Run the vacuum for at least 15 minutes, or until the Compound Meter reads -76cmHg (-10^5Pa) or 500 microns.
7. Close the Low-Pressure side of the manifold gauge, and turn off the vacuum pump.
8. Wait for 5 minutes, then check that there has been no change in system pressure.
9. If there is a change in system pressure, refer to Gas Leak Check section for information on how to check for leaks. If there is no change in system pressure, unscrew the cap from the packed valve (high-pressure valve).
10. Insert hexagonal wrench into the packed valve (high-pressure valve) and open the valve by turning the wrench in a $1/4$ counterclockwise turn. Listen for gas to exit the system, then close the valve after 5 seconds.
11. Watch the Pressure Gauge for one minute to make sure that there is no change in pressure. The Pressure Gauge should read slightly higher than atmospheric pressure.
12. Remove the charge hose from the service port.

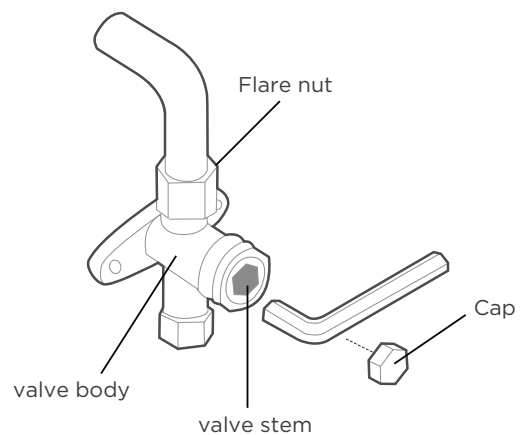

13. Using hexagonal wrench, fully open both the high-pressure and low-pressure valves.
14. Tighten all valve caps hand tight plus one flat to ensure no leaks. You may tighten it further using a torque wrench if needed.

NOTE ON ADDING REFRIGERANT

⚠ CAUTION

DO NOT mix refrigerant types.

Some systems require additional charging depending on pipe lengths. In North America, the standard pipe length is 25ft (7.5m). The refrigerant should be charged from the service port on the outdoor unit's low pressure valve. The additional refrigerant to be charged can be calculated using the following formula:

| Refrigerant | Liquid Side Diameter | |
|-------------------------------------------------------|-------------------------------------------------------------------|-------------------------------------------------------------------|
| | Ø1/4in (Ø6.35mm) | Ø3/8in (Ø9.52mm) |
| R454B: (orifice tube in the indoor unit): | (Total pipe length - standard pipe length) ×30g (0.32oz)/m(ft) | (Total pipe length - standard pipe length) ×65g (0.7oz)/m(ft) |
| R454B: (orifice tube in the outdoor unit): | (Total pipe length - standard pipe length) ×15g (0.16oz)/m(ft) | (Total pipe length - standard pipe length) ×30g (0.32oz)/m(ft) |

TEST RUN

CAUTION

Failure to perform the test run may result in unit damage, property damage, or personal injury.

Before test run

A test run must be performed after the entire system has been completely installed. Confirm the following points before performing the test:

- a) Indoor and outdoor units are properly installed.
- b) Piping and wiring are properly connected.
- c) No obstacles near the inlet and outlet of the unit that might cause poor performance or product malfunction.
- d) Refrigeration system does not leak.
- e) Drainage system is unimpeded and draining to a safe location.
- f) Heating insulation is properly installed.
- g) Grounding wires are properly connected.
- h) Length of the piping and additional refrigerant capacity have been recorded.
- i) Power voltage is the correct voltage for the air conditioner

Test run Instructions

1. Open both the liquid and gas service valves.
2. Turn on the main power switch and allow the unit to warm up.
3. Set the air conditioner to COOL mode.
4. For the Indoor Unit
 - a. Double check to see if the room temperature is being registered correctly.
 - b. Check to see that the drainage system is unimpeded and draining smoothly.
 - c. Ensure there is no vibration or abnormal noise during operation.

5. For the Outdoor Unit

- a. Check to see if the refrigeration system is leaking.
- b. Make sure there is no vibration or abnormal noise during operation.
- c. Ensure the wind, noise, and water generated by the unit do not disturb your neighbors or pose a safety hazard.

6. Drainage Test

- a. Ensure the drainpipe flows smoothly. New buildings should perform this test before finishing the ceiling.
- b. Turn on the main power switch and run the air conditioner in COOL mode.
- c. Check to see that the water is discharged. It may take up to one minute before the unit begins to drain depending on the drainpipe.
- d. Make sure that there are no leaks in any of the piping.
- e. Stop the air conditioner. Turn off the main power switch and reinstall the test cover.

NOTICE

If the unit malfunctions or does not operate according to your expectations, please refer to the Troubleshooting section of Service Manual before calling customer service.

ACCIO

The design and specifications are subject to change without prior notice for product improvement. Consult with the sales agency or manufacturer for details. Any updates to the manual will be uploaded to the service website, please check for the latest version.