



WWW.BULLBBQ.COM

MASTER Q ISLAND

W/31" TOP

SPEC SHEET

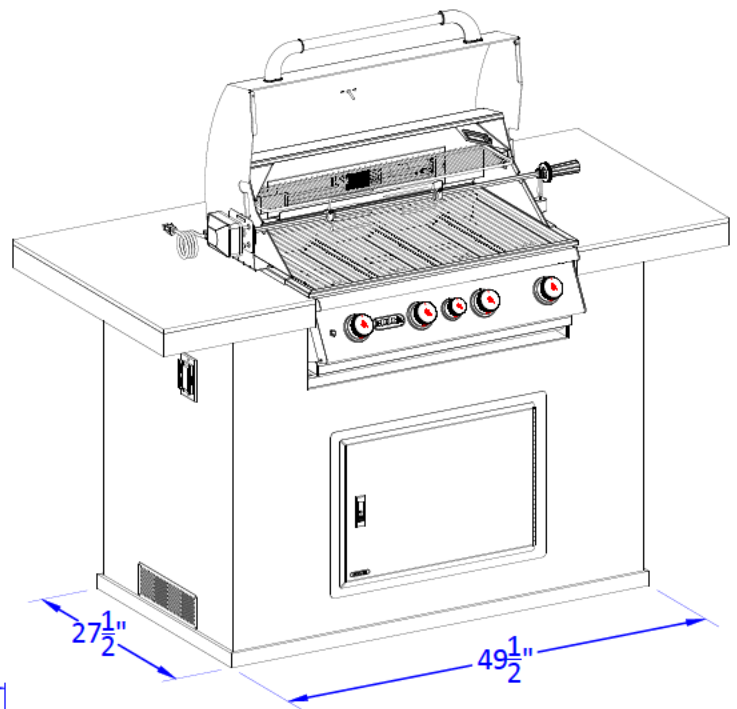

PERSPECTIVE VIEW

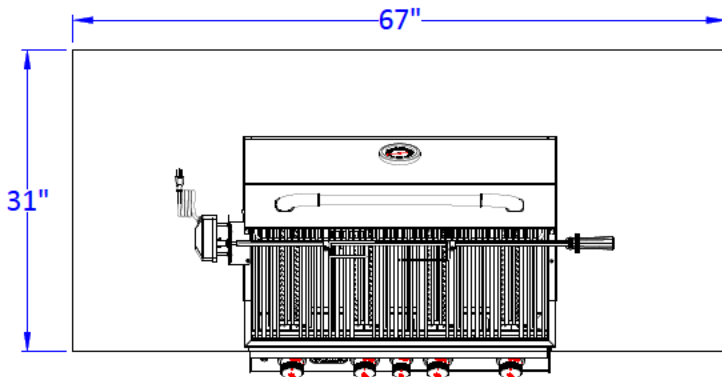

TOP VIEW

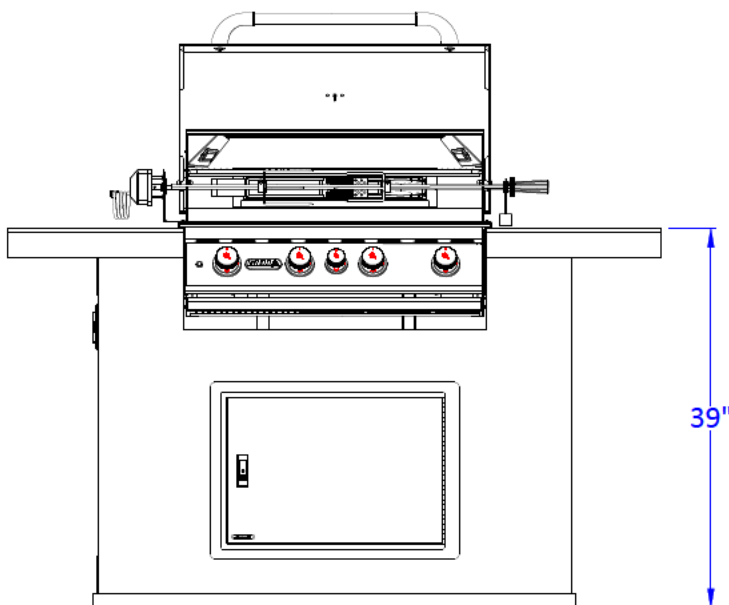

FRONT VIEW

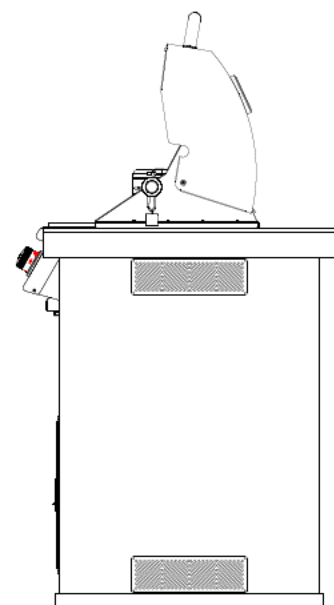

RIGHT SIDE VIEW

NOTES:

- 1) ALL DIMENSIONS ARE IN INCH UNITS
- 2) FOR ROCK FINISHES, ADD 1-1/2" ON ALL BASE SIDES.
- 3) 6" MAX ON ALL STUB-UPS.
- 4) SHOWN WITH 4-BURNER ANGUS GRILL & STANDARD FEATURES