

# SERVICE MANUAL

**Series PKA** **Wall Mounted** **R454B**

Indoor unit  
[Model Name]

[Service Ref.]

PKA-AK24NL

**PKA-AK24NL-U1**

PKA-AK30NL

**PKA-AK30NL-U1**

PKA-AK36NL

**PKA-AK36NL-U1**

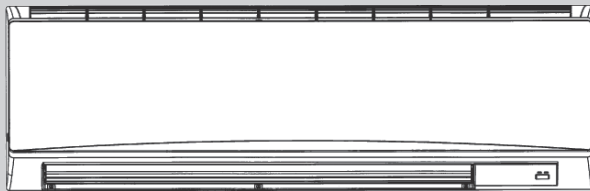

INDOOR UNIT



WIRELESS REMOTE  
CONTROLLER  
(Option)



WIRED REMOTE  
CONTROLLER  
(Option)

## CONTENTS

1. REFERENCE MANUAL.....	2
2. SAFETY PRECAUTION.....	3
3. PARTS NAMES AND FUNCTIONS.....	8
4. SPECIFICATIONS.....	9
5. NOISE CRITERION CURVES.....	10
6. OUTLINES AND DIMENSIONS.....	11
7. WIRING DIAGRAM.....	12
8. REFRIGERANT SYSTEM DIAGRAM.....	13
9. TROUBLESHOOTING.....	14
10. FUNCTION SETTING.....	28
11. SPECIAL FUNCTION.....	29
12. DISASSEMBLY PROCEDURE.....	32
13. REMOTE CONTROLLER.....	36

**PARTS CATALOG (OCB859)**



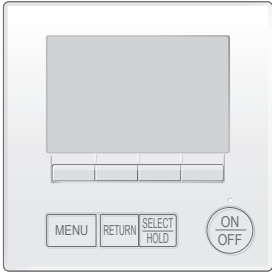
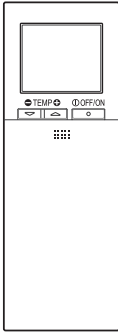

## OUTDOOR UNIT SERVICE MANUAL

Model Name	Service Ref.	Service Manual No. / Parts Catalog No.
PUZ-AH24/30NL PUY-AH24/30NL	PUZ-AH24/30NL-U1 PUY-AH24/30NL-U1	OCH871 / OCB871
PUZ-AK36NL PUY-AK36NL	PUZ-AK36-U1 PUY-AK36-U1	OCH869 / OCB869
PUZ-AK24/30/36NLHZ	PUZ-AK24/30/36NLHZ-U1	OCH870 / OCB870

■ Remote controller (Optional parts)

Wired remote controller	Wireless remote controller
	

## MEANINGS OF SYMBOLS DISPLAYED ON THE UNIT

	<b>WARNING</b> (Risk of fire)	This unit uses a flammable refrigerant. If the refrigerant leaks and comes in contact with fire or a heating part, it will create a harmful gas and there is a risk of fire.
		Read the OPERATION MANUAL carefully before operation.
		Service personnel are required to carefully read the OPERATION MANUAL and INSTALLATION MANUAL before operation.
		Further information is available in the OPERATION MANUAL, INSTALLATION MANUAL, and the like.

## 2-1. ALWAYS OBSERVE FOR SAFETY

**Before obtaining access to terminal, all supply circuits must be disconnected.**

## 2-2. CAUTIONS RELATED TO NEW REFRIGERANT

## Cautions for units utilizing refrigerant R454B

**Do not use the existing refrigerant piping.**

The old refrigerant and lubricant in the existing piping contains a large amount of chlorine which may cause the lubricant deterioration of the new unit.

**Make sure that the inside and outside of refrigerant piping is clean and it has no contaminants such as sulfur, oxides, dirt, shaving particles, etc., which are hazard to refrigerant cycle. In addition, use pipes with specified thickness.**

Contamination inside refrigerant piping can cause deterioration of refrigerant oil, etc.

**Store the piping indoors, and keep both ends of the piping sealed until just before brazing. (Leave elbow joints, etc. in their packaging.)**

If dirt, dust or moisture enters into refrigerant cycle, that can cause deterioration of refrigerant oil or malfunction of compressor.

**The refrigerant oil applied to flare and flange connections must be ester oil, ether oil or alkylbenzene oil in a small amount.**

If large amount of mineral oil enters, that can cause deterioration of refrigerant oil, etc.

**Charge refrigerant from liquid phase of gas cylinder.**

If the refrigerant is charged from gas phase, composition change may occur in refrigerant and the efficiency will be lowered.

**Ventilate the room if refrigerant leaks during operation. If refrigerant comes into contact with a flame, poisonous gases will be released.**

**Use a vacuum pump with a reverse flow check valve.**

Vacuum pump oil may flow back into refrigerant cycle and that can cause deterioration of refrigerant oil, etc.

**Use the following tools specifically designed for use with R454B refrigerant.**

The following tools are necessary to use R454B refrigerant.

Tools for R454B	
Gauge manifold	Flare tool
Charge hose	Size adjustment gauge
Gas leak detector	Vacuum pump adaptor
Torque wrench	Electronic refrigerant charging scale

**Handle tools with care.**

If dirt, dust or moisture enters into refrigerant cycle, that can cause deterioration of refrigerant oil or malfunction of compressor.

**Do not use a charging cylinder.**

If a charging cylinder is used, the composition of refrigerant will change and the efficiency will be lowered.

**Use the specified refrigerant only.****Never use any refrigerant other than that specified.**

Doing so may cause a burst, an explosion, or fire when the unit is being used, serviced, or disposed of. Correct refrigerant is specified on name plate of outdoor unit.

If other refrigerant (R22, etc.) is used, chlorine in refrigerant can cause deterioration of refrigerant oil, etc. We will not be held responsible for mechanical failure, system malfunction, unit breakdown or accidents caused by failure to follow the instructions.

## [1] Warning for service

- (1) Do not alter the unit.
- (2) For installation and relocation work, follow the instructions in the Installation Manual and use tools and pipe components specifically made for use with refrigerant specified in the outdoor unit installation manual.
- (3) Ask a dealer or an authorized technician to install, relocate and repair the unit.
- (4) This unit should be installed in rooms which exceed the floor space specified in outdoor unit installation manual. Refer to outdoor unit installation manual.
- (5) Install the indoor unit at least 1.8 m above floor or grade level.  
For appliances not accessible to the general public.
- (6) Refrigerant pipes connection shall be accessible for maintenance purposes.
- (7) If the air conditioner is installed in a small room or closed room, measures must be taken to prevent the refrigerant concentration in the room from exceeding the safety limit in the event of refrigerant leakage. Should the refrigerant leak and cause the concentration limit to be exceeded, hazards due to lack of oxygen in the room may result.
- (8) Keep gas-burning appliances, electric heaters, and other fire sources (ignition sources) away from the location where installation, repair, and other air conditioner work will be performed.  
If refrigerant comes into contact with a flame, poisonous gases will be released.
- (9) When installing or relocating, or servicing the air conditioner, use only the specified refrigerant written on outdoor unit to charge the refrigerant lines.  
Do not mix it with any other refrigerant and do not allow air to remain in the lines.  
If air is mixed with the refrigerant, then it can be the cause of abnormal high pressure in the refrigerant line, and may result in an explosion and other hazards.
- (10) After installation has been completed, check for refrigerant leaks. If refrigerant leaks into the room and comes into contact with the flame of a heater or portable cooking range, poisonous gases will be released.
- (11) Do not use low temperature solder alloy in case of brazing the refrigerant pipes.
- (12) When performing brazing work, be sure to ventilate the room sufficiently. Make sure that there are no hazardous or flammable materials nearby.  
When performing the work in a closed room, small room, or similar location, make sure that there are no refrigerant leaks before performing the work.  
If refrigerant leaks and accumulates, it may ignite or poisonous gases may be released.
- (13) Do not install the unit in places where refrigerant may build-up or places with poor ventilation such as a semi-basement or a sunken place in outdoor: Refrigerant is heavier than air, and inclined to fall away from the leak source.
- (14) Do not use means to accelerate the defrosting process or to clean, other than those recommended by the manufacturer.
- (15) The appliance shall be stored in a room without continuously operating ignition sources (for example: open flames, an operating gas appliance or an operating electric heater).
- (16) Do not pierce or burn.
- (17) Be aware that refrigerants may not contain an odour.
- (18) Pipe-work shall be protected from physical damage.
- (19) The installation of pipe-work shall be kept to a minimum.
- (20) Compliance with national gas regulations shall be observed.
- (21) Keep any required ventilation openings clear of obstruction.
- (22) Servicing shall be performed only as recommended by the manufacturer.
- (23) The appliance shall be stored in a well-ventilated area where the room size corresponds to the room area as specified for operation.
- (24) Maintenance, service and repair operations shall be performed by authorized technician with required qualification.

## [2] Cautions for service

- (1) Perform service after recovering the refrigerant left in unit completely.
- (2) Do not release refrigerant in the air.
- (3) After completing service, charge the cycle with specified amount of refrigerant.
- (4) When performing service, install a filter drier simultaneously.  
Be sure to use a filter drier for new refrigerant.

## [3] Additional refrigerant charge

### When charging directly from cylinder

- (1) Check that cylinder for R454B available on the market is a syphon type.
- (2) Charging should be performed with the cylinder of syphon stood vertically. (Refrigerant is charged from liquid phase.)

#### [4] Cautions for unit using R454B refrigerant

Basic work procedures are the same as those for conventional units using refrigerant R410A. However, pay careful attention to the following points.

(1) Information on servicing

(1-1) Checks to the area

Prior to beginning work on systems containing FLAMMABLE REFRIGERANTS, safety checks are necessary to ensure that the risk of ignition is minimized.

For repair to the REFRIGERATING SYSTEM, 1-2 to 1-6 shall be completed prior to conducting work on the system.

(1-2) Work Procedure

Work shall be undertaken under a controlled procedure so as to minimize the risk of a flammable gas or vapour being present while the work is being performed.

(1-3) General work area

All maintenance staff and others working in the local area shall be instructed on the nature of work being carried out.

Work in confined spaces shall be avoided.

(1-4) Checking for presence of refrigerant

The area shall be checked with an appropriate refrigerant detector prior to and during work, to ensure the technician is aware of potentially toxic or flammable atmospheres.

Ensure that the leak detection equipment being used is suitable for use with all applicable refrigerants, i.e. non-sparking, adequately sealed or intrinsically safe.

(1-5) Presence of fire extinguisher

If any hot work is to be conducted on the refrigerating equipment or any associated parts, appropriate fire extinguishing equipment shall be available to hand.

Have a dry powder or CO<sub>2</sub> fire extinguisher adjacent to the charging area.

(1-6) No ignition sources

No person carrying out work in relation to a REFRIGERATING SYSTEM which involves exposing any pipe work shall use any sources of ignition in such a manner that it may lead to the risk of fire or explosion.

All possible ignition sources, including cigarette smoking, should be kept sufficiently far away from the site of installation, repairing, removing and disposal, during which refrigerant can possibly be released to the surrounding space.

Prior to work taking place, the area around the equipment is to be surveyed to make sure that there are no flammable hazards or ignition risks. "No Smoking" signs shall be displayed.

(1-7) Ventilated area

Ensure that the area is in the open or that it is adequately ventilated before breaking into the system or conducting any hot work. A degree of ventilation shall continue during the period that the work is carried out.

The ventilation should safely disperse any released refrigerant and preferably expel it externally into the atmosphere.

(1-8) Checks to the refrigerating equipment

Where electrical components are being changed, they shall be fit for the purpose and to the correct specification.

At all times the manufacturer's maintenance and service guidelines shall be followed. If in doubt, consult the manufacturer's technical department for assistance.

The following checks shall be applied to installations using FLAMMABLE REFRIGERANTS:

- the actual REFRIGERANT CHARGE is in accordance with the room size within which the refrigerant containing parts are installed.
- the ventilation machinery and outlets are operating adequately and are not obstructed.
- marking to the equipment continues to be visible and legible. Markings and signs that are illegible shall be corrected.
- refrigerating pipe or components are installed in a position where they are unlikely to be exposed to any substance which may corrode refrigerant containing components, unless the components are constructed of materials which are inherently resistant to being corroded or are suitably protected against being so corroded.

(1-9) Checks to electrical devices

Repair and maintenance to electrical components shall include initial safety checks and component inspection procedures. If a fault exists that could compromise safety, then no electrical supply shall be connected to the circuit until it is satisfactorily dealt with.

If the fault cannot be corrected immediately but it is necessary to continue operation, an adequate temporary solution shall be used. This shall be reported to the owner of the equipment so all parties are advised.

Initial safety checks shall include:

- that capacitors are discharged: this shall be done in a safe manner to avoid possibility of sparking.
- that no live electrical components and wiring are exposed while charging, recovering or purging the system.
- that there is continuity of earth bonding.

(2) Repairs to sealed components

Sealed electrical components shall be replace.

(3) Repair to intrinsically safe components

Intrinsically safe components must be replaced.

(4) Cabling

Check that cabling will not be subject to wear, corrosion, excessive pressure, vibration, sharp edges or any other adverse environmental effects.

The check shall also take into account the effects of aging or continual vibration from sources such as compressors or fans.

(5) Detection of flammable refrigerants

Under no circumstances shall potential sources of ignition be used in the searching for or detection of refrigerant leaks. A halide torch (or any other detector using a naked flame) shall not be used.

The following leak detection methods are deemed acceptable for all refrigerant systems.

Electronic leak detectors may be used to detect refrigerant leaks but, in the case of FLAMMABLE REFRIGERANTS, the sensitivity may not be adequate, or may need re-calibration. (Detection equipment shall be calibrated in a refrigerant-free area.)

Ensure that the detector is not a potential source of ignition and is suitable for the refrigerant used.

Leak detection equipment shall be set at a percentage of the LFL of the refrigerant and shall be calibrated to the refrigerant employed, and the appropriate percentage of gas (25 % maximum) is confirmed.

Leak detection fluids are also suitable for use with most refrigerants but the use of detergents containing chlorine shall be avoided as the chlorine may react with the refrigerant and corrode the copper pipe-work.

If a leak is suspected, all naked flames shall be removed / extinguished.

If a leakage of refrigerant is found which requires brazing, all of the refrigerant shall be recovered from the system, or isolated (by means of shut off valves) in a part of the system remote from the leak. Removal of refrigerant shall be according to 2-4.6.

(6) Removal and evacuation

When breaking into the refrigerant circuit to make repairs - or for any other purpose -conventional procedures shall be used. However, for flammable refrigerants it is important that best practice be followed, since flammability is a consideration.

The following procedure shall be adhered to:

- safely remove refrigerant following local and national regulations;
  - evacuate
  - purge the circuit with inert gas
  - evacuate
  - continuously flush or purge with inert gas when using flame to open circuit
  - open the circuit

The refrigerant charge shall be recovered into the correct recovery cylinders if venting is not allowed by local and national codes.

For appliances containing flammable refrigerants, the system shall be purged with oxygen-free nitrogen to render the appliance safe for flammable refrigerants. This process might need to be repeated several times.

Compressed air or oxygen shall not be used for purging refrigerant systems.

For appliances containing flammable refrigerants, refrigerants purging shall be achieved by breaking the vacuum in the system with oxygen-free nitrogen and continuing to fill until the working pressure is achieved, then venting to atmosphere, and finally pulling down to a vacuum.

This process shall be repeated until no refrigerant is within the system. When the final oxygen-free nitrogen charge is used, the system shall be vented down to atmospheric pressure to enable work to take place.

The outlet for the vacuum pump shall not be close to any potential ignition sources, and ventilation shall be available.

(7) Charging procedures

In addition to conventional charging procedures, the following requirements shall be followed.

- Ensure that contamination of different refrigerants does not occur when using charging equipment. Hoses or lines shall be as short as possible to minimize the amount of REFRIGERANT contained in them.
- Cylinders shall be kept in an appropriate position according to the instructions.
- Ensure that the REFRIGERATING SYSTEM is earthed prior to charging the system with refrigerant.
- Label the system when charging is complete (if not already).
- Extreme care shall be taken not to overfill the REFRIGERATING SYSTEM.

Prior to recharging the system, it shall be pressure-tested with the appropriate purging gas. The system shall be leak-tested on completion of charging but prior to commissioning. A follow up leak test shall be carried out prior to leaving the site.

(8) Decommissioning

Before carrying out this procedure, it is essential that the technician is completely familiar with the equipment and all its detail. It is recommended good practice that all refrigerants are recovered safely.

Prior to the task being carried out, an oil and refrigerant sample shall be taken in case analysis is required prior to re-use of recovered refrigerant. It is essential that electrical power is available before the task is commenced.

- a) Become familiar with the equipment and its operation.
- b) Isolate system electrically.
- c) Before attempting the procedure, ensure that:
  - mechanical handling equipment is available, if required, for handling refrigerant cylinders.
  - all personal protective equipment is available and being used correctly.
  - the recovery process is supervised at all times by a competent person.
  - recovery equipment and cylinders conform to the appropriate standards.
- d) Pump down refrigerant system, if possible.
- e) If a vacuum is not possible, make a manifold so that refrigerant can be removed from various parts of the system.
- f) Make sure that cylinder is situated on the scales before recovery takes place.
- g) Start the recovery machine and operate in accordance with instructions.
- h) Do not overfill cylinders. (no more than 80 % volume liquid charge)
- i) Do not exceed the maximum working pressure of the cylinder, even temporarily.
- j) When the cylinders have been filled correctly and the process completed, make sure that the cylinders and the equipment are removed from site promptly and all isolation valves on the equipment are closed off.
- k) Recovered refrigerant shall not be charged into another REFRIGERATING SYSTEM unless it has been cleaned and checked.

(9) Labelling

Equipment shall be labelled stating that it has been de-commissioned and emptied of refrigerant.

The label shall be dated and signed. For appliances containing FLAMMABLE REFRIGERANTS, ensure that there are labels on the equipment stating the equipment contains FLAMMABLE REFRIGERANT.

(10) Recovery

When removing refrigerant from a system, either for servicing or decommissioning, it is recommended good practice that all refrigerants are removed safely.

When transferring refrigerant into cylinders, ensure that only appropriate refrigerant recovery cylinders are employed. Ensure that the correct number of cylinders for holding the total system charge is available.

All cylinders to be used are designated for the recovered refrigerant and labelled for that refrigerant (i.e. special cylinders for the recovery of refrigerant). Cylinders shall be complete with pressure-relief valve and associated shut-off valves in good working order.

Empty recovery cylinders are evacuated and, if possible, cooled before recovery occurs.

The recovery equipment shall be in good working order with a set of instructions concerning the equipment that is at hand and shall be suitable for the recovery of the flammable refrigerant.

If in doubt, the manufacturer should be consulted. In addition, a set of calibrated weighing scales shall be available and in good working order. Hoses shall be complete with leak-free disconnect couplings and in good condition.

The recovered refrigerant shall be processed according to local legislation in the correct recovery cylinder, and the relevant waste transfer note arranged. Do not mix refrigerants in recovery units and especially not in cylinders.

If compressors or compressor oils are to be removed, ensure that they have been evacuated to an acceptable level to make certain that flammable refrigerant does not remain within the lubricant.

The compressor body shall not be heated by an open flame or other ignition sources to accelerate this process.

When oil is drained from a system, it shall be carried out safely.

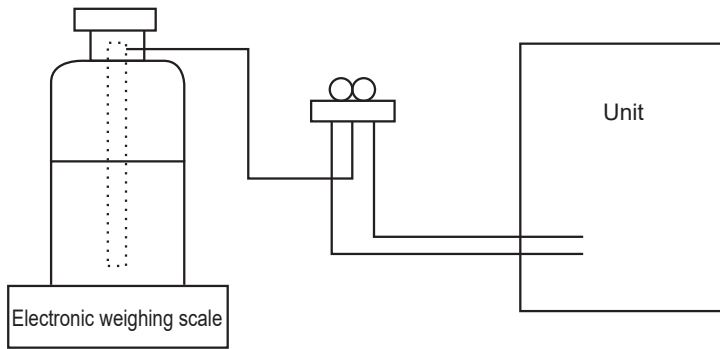

### [5] Service tools

Use the below service tools as exclusive tools for R454B refrigerant.

No.	Tool name	Specifications
①	Gauge manifold	· Only for R454B
		· Use the existing fitting specifications. (UNF1/2)
		· Use high-tension side pressure of 768.7 PSIG [5.3 MPa.G] or over.
②	Charge hose	· Only for R454B
		· Use pressure performance of 738.2 PSIG [5.09 MPa.G] or over.
③	Electronic weighing scale	—
④	Gas leak detector	· Use the detector for R454B.
⑤	Adaptor for reverse flow check	· Attach on vacuum pump.
⑥	Refrigerant charge base	—
⑦	Refrigerant cylinder	· Only for R454B
		· Cylinder with syphon
⑧	Refrigerant recovery equipment	—

## 3 PARTS NAMES AND FUNCTIONS

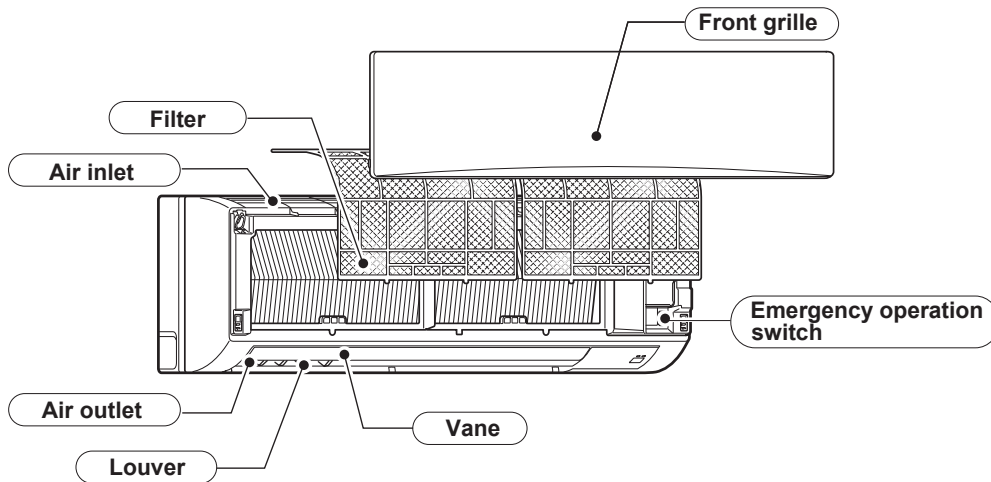



# 4

# SPECIFICATIONS

Service Ref.			PKA-AK24NL-U1	
INDOOR UNIT	Power supply(phase, cycle, voltage)		1-phase, 60 Hz, 208/230 V	
	Max. Fuse Size	A	15	
	Min.Circuit Ampacity	A	1	
	External finish		White Munsell 0.7PB 9.2/0.4	
	Heat exchanger		Plate fin coil	
	Fan	Fan (drive) × No.		Line flow fan (direct) × 1
		Fan motor output	kW	0.069
		Fan motor	F.L.A	0.265
		Airflow (Low-Middle-High)	CFM (m <sup>3</sup> /min)	Dry: 635-705-775 (18-20-22)
				Wet: 635-705-775 (18-20-22)
	External static pressure	Pa (mmAq)	0 (direct blow)	
	Operation control & Thermostat		Remote controller & built-in	
	Noise level (Low-Middle-High)		39-42-45	
	Field drain pipe I.D.		16 (5/8)	
	Dimensions	W	mm (in.)	1170 (46-1/16)
D		mm (in.)	295 (11-5/8)	
H		mm (in.)	365 (14-3/8)	
Weight		kg (lbs)	21 (46)	

Service Ref.			PKA-AK30NL-U1	
INDOOR UNIT	Power supply (phase, cycle, voltage)		1-phase, 60 Hz, 208/230 V	
	Max. Fuse Size	A	15	
	Min.Circuit Ampacity	A	1	
	External finish		White Munsell 0.7PB 9.2/0.4	
	Heat exchanger		Plate fin coil	
	Fan	Fan (drive) × No.		Line flow fan (direct) × 1
		Fan motor output	kW	0.069
		Fan motor	F.L.A	0.265
		Airflow (Low-Middle-High)	CFM (m <sup>3</sup> /min)	Dry: 635-705-775 (18-20-22)
				Wet: 635-705-775 (18-20-22)
	External static pressure	Pa (mmAq)	0 (direct blow)	
	Operation control & Thermostat		Remote controller & built-in	
	Noise level (Low-Middle-High)		39-42-45	
	Field drain pipe I.D.		16 (5/8)	
	Dimensions	W	mm (in.)	1170 (46-1/16)
D		mm (in.)	295 (11-5/8)	
H		mm (in.)	365 (14-3/8)	
Weight		kg (lbs)	21 (46)	

Service Ref.			PKA-AK36NL-U1	
INDOOR UNIT	Power supply (phase, cycle, voltage)		1-phase, 60 Hz, 208/230 V	
	Max. Fuse Size	A	15	
	Min.Circuit Ampacity	A	1	
	External finish		White Munsell 0.7PB 9.2/0.4	
	Heat exchanger		Plate fin coil	
	Fan	Fan (drive) × No.		Line flow fan (direct) × 1
		Fan motor output	kW	0.069
		Fan motor	F.L.A	0.265
		Airflow (Low-Middle-High)	CFM (m <sup>3</sup> /min)	Dry: 705-810-920 (20-23-26)
				Wet: 705-810-920 (20-23-26)
	External static pressure	Pa (mmAq)	0 (direct blow)	
	Operation control & Thermostat		Remote controller & built-in	
	Noise level (Low-Middle-High)		43-46-49	
	Field drain pipe I.D.		16 (5/8)	
	Dimensions	W	mm (in.)	1170 (46-1/16)
D		mm (in.)	295 (11-5/8)	
H		mm (in.)	365 (14-3/8)	
Weight		kg (lbs)	21 (46)	

# 5

# NOISE CRITERION CURVES

PKA-AK24NL-U1  
PKA-AK30NL-U1

NOTCH	SPL(dB)	LINE
High	45	○—○
Low	39	●—●

PKA-AK36NL-U1

NOTCH	SPL(dB)	LINE
High	49	○—○
Low	43	●—●

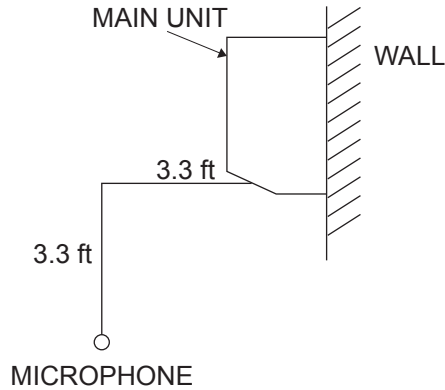
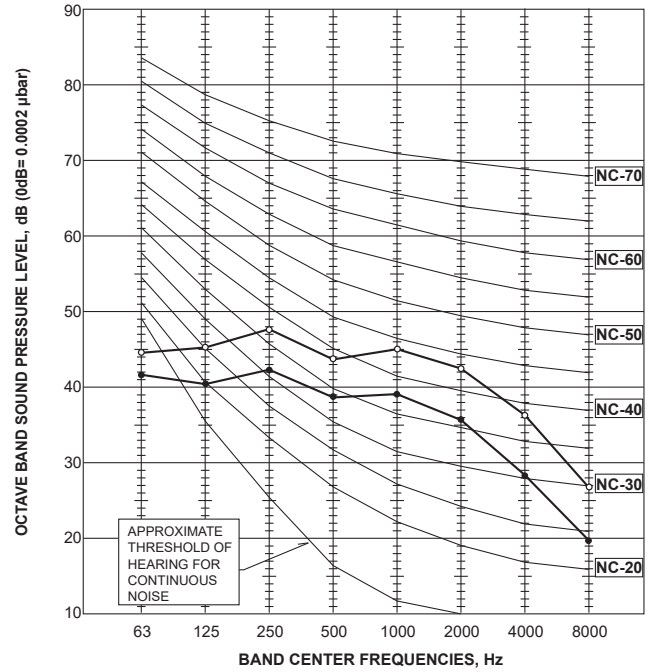
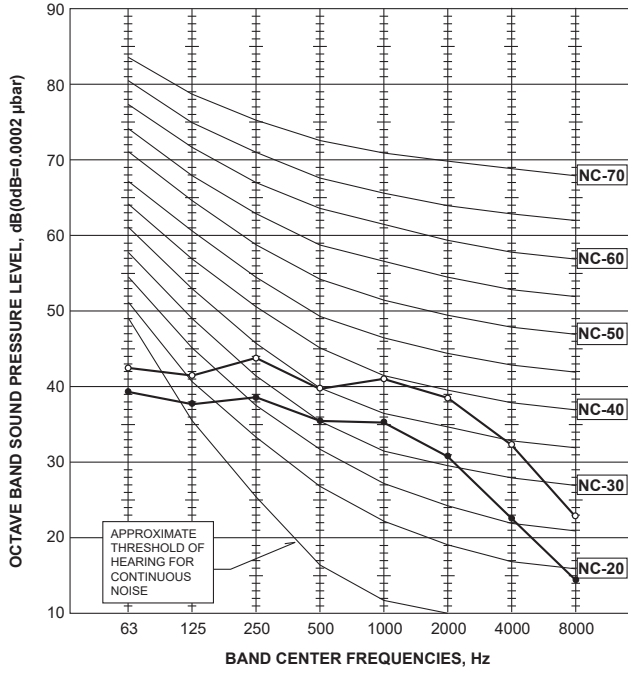

OUTLINES AND DIMENSIONS

Unit: mm (in.)

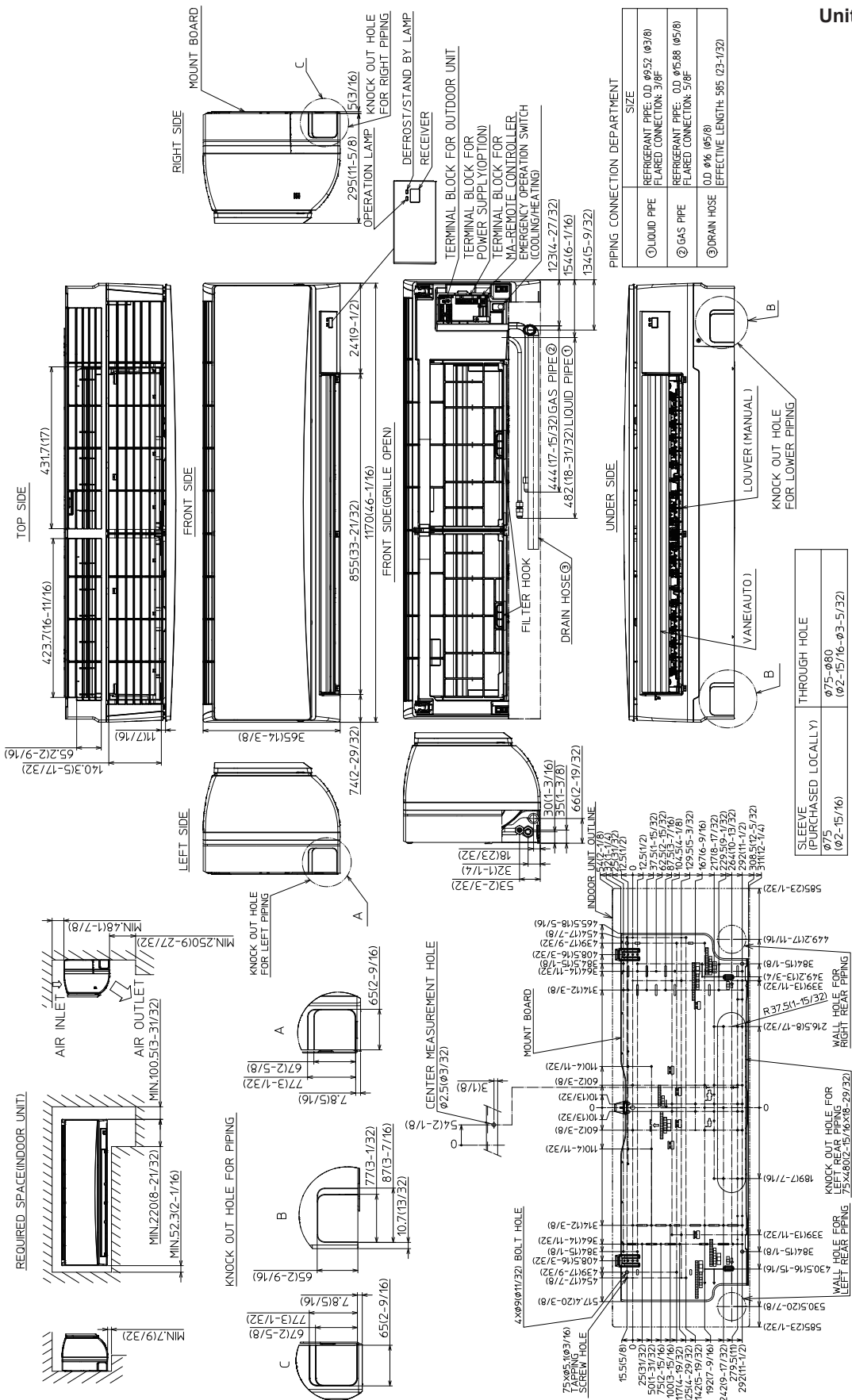

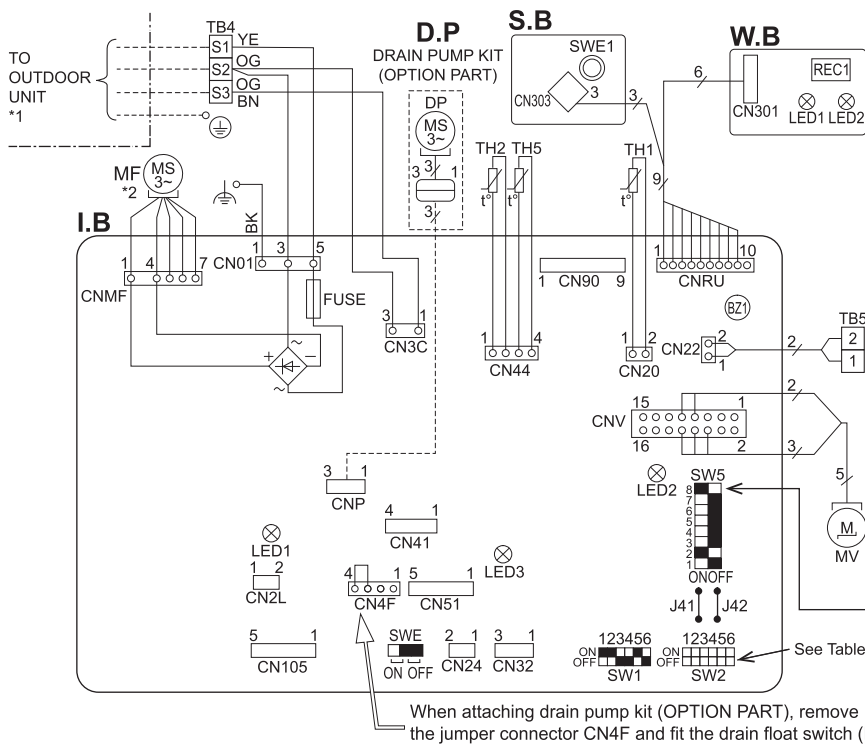

**NOTES:**

1. Symbols used in wiring diagram on the left are, : terminal block, : connector.
2. Indoor and outdoor connecting wires are made with polarities, make wiring matching terminal numbers (S1, S2, S3).
3. Since the outdoor side electric wiring may change, be sure to check the outdoor unit electric wiring for servicing.
4. This diagram shows the wiring of indoor and outdoor connecting wires (specification of 208V/230V AC 60Hz), adopting superimposed system of power and signal.
5. The black square (■) in the wiring diagram indicates a switch position.

- For power supply system of this unit, refer to the caution label located near this diagram.
- \*1: Use copper supply wires. Utiliser des fils d'alimentation en cuivre.
- \*2: Be sure to turn off the source power and then disconnect fan motor connector. (Failure to do so will cause trouble in Fan motor)

<Table 1>

MODEL	SW2	MODEL	SW2
24	ON OFF	36	ON OFF
30	ON OFF		

\* Turn it off when a remote controller other than PAR-4\*MAAUB/CT01MAU is connected\*

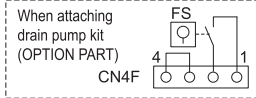

When attaching drain pump kit (OPTION PART), remove the jumper connector CN4F and fit the drain float switch (FS).

[LEGEND]

SYMBOL	NAME	SYMBOL	NAME
I.B	INDOOR CONTROLLER BOARD	MV	VANE MOTOR
BZ1	BUZZER	TB4	TERMINAL BLOCK
CNP	CONNECTOR	TB5	TERMINAL BLOCK
CN24	EXTERNAL HEATER	TH1	THERMISTOR
CN2L	LOSSNAY	TH2	THERMISTOR
CN32	REMOTE SWITCH	TH5	THERMISTOR
CN41	HA TERMINAL-A	S.B	SWITCH BOARD
CN4F	DRAIN FLOAT SWITCH (DRAIN PUMP (OPTION PARTS))	SWE1	EMERGENCY OPERATION
CN51	CENTRALLY CONTROL	W.B	PCB FOR WIRELESS RECEIVER
CN90	REMOTE OPERATION ADAPTER	REC1	RECEIVING UNIT
CN105	IT TERMINAL	LED1	LED (OPERATION INDICATION : GREEN)
FUSE	FUSE (T3.15A/250V)	LED2	LED (PREPARATION FOR HEATING : ORANGE)
LED1	POWER SUPPLY (I.B)	D.P	DRAIN PUMP KIT (OPTIONAL PARTS)
LED2	POWER SUPPLY (REMOTE CONTROLLER)	FS	DRAIN FLOAT SWITCH
LED3	TRANSMISSION (INDOOR-OUTDOOR)	DP	DRAIN PUMP
SW1	MODEL SELECTION		
SW2	CAPACITY CODE		
SW5	FUNCTION SETTING		
SWE	FAN-DRAIN PUMP (TEST MODE)		
MF	FAN MOTOR		

[Self-diagnosis]

1. For details on how to operate self-diagnosis with the wireless remote controller, refer to the technical manuals etc.

Check code	Symptom
P1	Abnormality of room temperature thermistor (TH1).
P2	Abnormality of pipe temperature thermistor/Liquid (TH2).
P4	Float switch connector open (FS).
P5	Malfunction of Drain pump.
P6	Freezing/overheating protection is working.
P8	Abnormality of pipe temperature.
P9	Abnormality of pipe temperature thermistor/Cond./Eva. (TH5).
PA	Leakage error (refrigerant system).
PB (Pb)	Indoor unit fan motor error.
PL	Refrigerant circuit abnormal.
E0-E5	Abnormality of the signal transmission between remote controller and indoor unit.
E6-EF	Abnormality of the signal transmission between indoor unit and outdoor unit.
FB (Fb)	Abnormality of indoor controller board.
U*, F*	Abnormality in outdoor unit. Refer to outdoor unit wiring diagram.

[Emergency operation procedure]

1. When the wired remote controller has failed, but all other components work properly, if you set the switch (SWE) on the indoor controller board ON, the indoor unit will begin emergency operation.
  - When emergency operation is activated, the indoor unit operates as follows:
    - (1) Indoor fan is running at high speed. (2) Drain pump is working.
    - Note on the wireless remote controller: When the remote controller does not function, it is possible to activate emergency operation by using the indoor unit emergency operation switch (SWE1 of the switch board).
2. When you activate emergency operation of the cooling or heating, you have to set the switch (SWE) on the indoor controller board and activate emergency operation of the outdoor unit.
  - For details on how to activate emergency operation of the outdoor unit, refer to the outdoor unit wiring diagram.
3. Before you activate emergency operation, check the following points:
  - (1) Emergency operation cannot be activated when:
    - The outdoor unit malfunctions. •The indoor fan malfunctions.
    - When it has detected the malfunction of drain pump during self-diagnosing.
  - (2) Emergency operation becomes continuous only by switching the power source on/off.
    - ON/OFF on the remote controller or temperature control etc. does not function.
  - (3) Avoid operating for a long time when the outdoor unit begins defrosting while emergency operation of the heating is activated, because it will start to blow cold air.
  - (4) Emergency cooling should be limited to 10 hours maximum (The indoor unit heat exchanger may freeze).
  - (5) After emergency operation has been deactivated, set the switches etc. to their original positions.
  - (6) Movement of the vanes does not work in emergency operation, therefore you have to slowly set them manually to the appropriate positions.

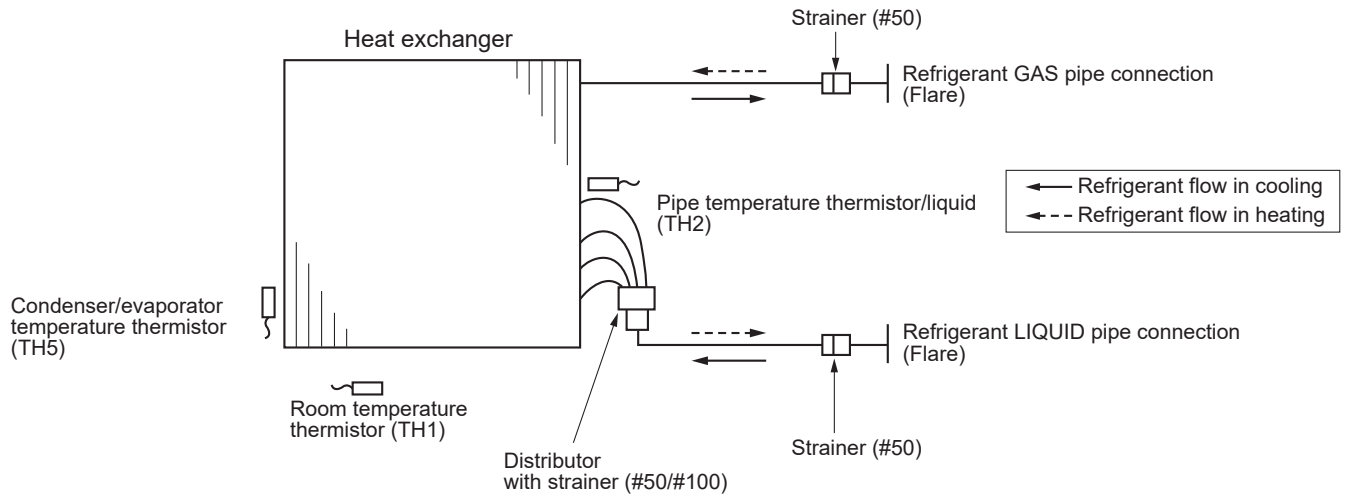

### 9-1. TROUBLESHOOTING

#### <Check code displayed by self-diagnosis and actions to be taken for service (summary)>

Present and past check codes are logged, and they can be displayed on the wired remote controller and control board of outdoor unit. Actions to be taken for service, which depends on whether or not the trouble is reoccurring in the field, are summarized in the table below. Check the contents below before investigating details.

Unit conditions at service	Check code	Actions to be taken for service (summary)
The trouble is reoccurring.	Displayed	Judge the problem and take a corrective action according to "9-3. SELF-DIAGNOSIS ACTION TABLE".
	Not displayed	Conduct troubleshooting and ascertain the cause of the trouble according to "9-4. TROUBLESHOOTING OF PROBLEMS".
The trouble is not reoccurring.	Logged	① Consider the temporary defects such as the work of protection devices in the refrigerant circuit including compressor, poor connection of wiring, noise, etc. Re-check the symptom, and check the installation environment, refrigerant amount, weather when the trouble occurred, matters related to wiring, etc. ② Reset check error code logs and restart the unit after finishing service. ③ There is no abnormality in electrical component, controller board, remote controller, etc.
	Not logged	① Re-check the abnormal symptom. ② Conduct troubleshooting and ascertain the cause of the trouble according to "9-4. TROUBLESHOOTING OF PROBLEMS". ③ Continue to operate unit for the time being if the cause is not ascertained. ④ There is no abnormality concerning of parts such as electrical component, controller board, remote controller, etc.

## 9-2. MALFUNCTION-DIAGNOSIS METHOD BY REMOTE CONTROLLER

- Refer to "13-7. SELF-DIAGNOSIS" to search for the error history.

### [Output pattern A]

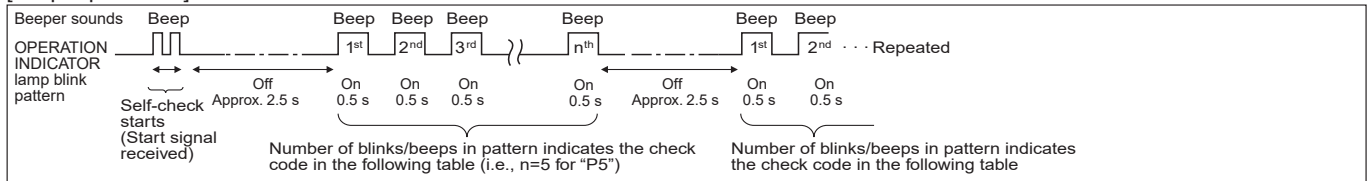

### [Output pattern B]

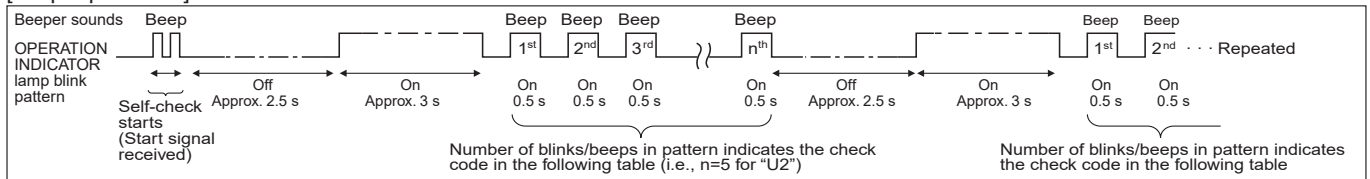

### [Output pattern A] Errors detected by indoor unit

Wireless remote controller	Wired remote controller	Symptom	Remarks
Beeper sounds/OPERATION INDICATOR lamp blinks (Number of times)	Check code		
1	P1	Intake sensor error	
2	P2	Pipe (TH2) sensor error	
	P9	Pipe (TH5) sensor error	
3	E6,E7	Indoor/outdoor unit communication error	
4	P4	Drain sensor error/Float switch connector (CN4F) open	
5	P5	Drain pump error	
	PA	Forced compressor stop(due to water leakage abnormality)	
6	P6	Freezing/Overheating protection operation	
7	EE	Combination error between indoor and outdoor units	
8	P8	Pipe temperature error	
9	E4, E5	Remote controller signal receiving error	
10	-	-	
11	Pb	Indoor unit fan motor error	
12	Fb (FB)*	Indoor unit control system error (memory error, etc.)	
14	PL	Abnormal refrigerant circuit	
No sound	E0, E3	Remote controller transmission error	
No sound	E1, E2	Remote controller control board error	
No sound	----	No corresponding	

### [Output pattern B] Errors detected by unit other than indoor unit (outdoor unit, etc.)

Wireless remote controller	Wired remote controller	Symptom	Remarks
Beeper sounds/OPERATION INDICATOR lamp blinks (Number of times)	Check code		
1	E9	Indoor/outdoor unit communication error (Transmitting error) (Outdoor unit)	For details, check the LED display of the outdoor controller board. As for outdoor unit, refer to outdoor unit's service manual.
2	UP	Compressor overcurrent interruption	
3	U3,U4	Open/short of outdoor unit thermistors	
4	UF	Compressor overcurrent interruption (When compressor locked)	
5	U2	Abnormal high discharge temperature/49C operated/insufficient refrigerant	
6	U1,Ud (UD)*	Abnormal high pressure (63H operated)/Overheating protection operation	
7	U5	Abnormal temperature of heat sink	
8	U8	Outdoor unit fan protection stop	
9	U6	Compressor overcurrent interruption/Abnormal of power module	
10	U7	Abnormality of super heat due to low discharge temperature	
11	U9,UH	Abnormality such as overvoltage or voltage shortage and abnormal synchronous signal to main circuit/Current sensor error	
12	-	-	
13	-	-	
14	Others	Other errors (Refer to the technical manual for the outdoor unit.)	

#### Notes:

- If the beeper does not sound again after the initial 2 beeps to confirm the self-check start signal was received and the OPERATION INDICATOR lamp does not come on, there are no error records.
- If the beeper sounds 3 times continuously "beep, beep, beep (0.4 + 0.4 + 0.4 seconds)" after the initial 2 beeps to confirm the self-check start signal was received, the specified refrigerant address is incorrect.

- On wireless remote controller  
The continuous buzzer sounds from receiving section of indoor unit.  
Blink of operation lamp
- On wired remote controller  
Check code displayed in the LCD. (Refer to the previous page, ① check code.)

• If the unit cannot be operated properly after test run, refer to the following table to find the cause.

Symptom		Cause
Wired remote controller	LED 1, 2 (PCB in outdoor unit)	
Please Wait	For about 3 minutes after power-on	After LED 1, 2 are lit, LED 2 is turned off, then only LED 1 is lit. (Correct operation)
Please Wait → Check code	Subsequent to about 3 minutes after power-on	• For about 3 minutes following power-on, operation of the remote controller is not possible due to system startup. (Correct operation)
Display messages do not appear even when operation switch is turned ON (operation lamp does not light up).		Only LED 1 is lit. → LED 1, 2 blink.
		• Connector for the outdoor unit's protection device is not connected. • Reverse or open phase wiring for the outdoor unit's power terminal block (L1, L2, GR).
		• Incorrect wiring between indoor and outdoor units (incorrect polarity of S1, S2, S3) • Remote controller wire short

On the wireless remote controller with condition above, following phenomena take place.

- No signals from the remote controller can be received.
- Operation lamp is blinking.
- The buzzer makes a short ping sound.

**Note:**

**Operation is not possible for about 30 seconds after cancellation of function selection. (Correct operation)**

For description of each LED (LED1, 2, 3) provided on the indoor controller, refer to the following table.

LED1 (power for microprocessor)	Indicates whether control power is supplied. Make sure that this LED is always lit.
LED2 (power for remote controller)	Indicates whether power is supplied to the remote controller. This LED lights only in the case of the indoor unit which is connected to the outdoor unit refrigerant addresses "0".
LED3 (communication between indoor and outdoor units)	Indicates state of communication between the indoor and outdoor units. Make sure that this LED is always blinking.



### 9-3. SELF-DIAGNOSIS ACTION TABLE

Note:

Errors to be detected in outdoor unit, such as codes starting with F, U or E (excluding E0 to E7), are not covered in this document. Please refer to the outdoor unit service manual for the details.

Check code	Abnormal point and detection method	Cause	Countermeasure
P1	<p><b>Room temperature thermistor (TH1)</b></p> <p>① The unit is in 3-minute resume prevention mode if short/open of thermistor is detected. Abnormal if the unit does not reset normally after 3 minutes. (The unit returns to normal operation, if it has been reset normally.)</p> <p>② Constantly detected during cooling, drying, and heating operation. Short: 90°C [194°F] or more Open: -40°C [-40°F] or less</p>	<p>① Defective thermistor characteristics</p> <p>② Contact failure of connector (CN20) on the indoor controller board (Insert failure)</p> <p>③ Breaking of wire or contact failure of thermistor wiring</p> <p>④ Defective indoor controller board</p>	<p>①–③ Check resistance value of thermistor.</p> <p>0°C [32°F]...15.0 kΩ 10°C [50°F].....9.6 kΩ 20°C [68°F].....6.3 kΩ 30°C [86°F].....4.3 kΩ 40°C [104°F].....3.0 kΩ</p> <p>If you put force on (draw or bend) the lead wire with measuring resistance value of thermistor, breaking of wire or contact failure can be detected.</p> <p>② Check contact failure of connector (CN20) on the indoor controller board. Refer to "9-7. TEST POINT DIAGRAM". Turn the power on again and check restart after inserting connector again.</p> <p>④ Check room temperature display on remote controller. Replace indoor controller board if there is abnormal difference with actual room temperature.</p> <p>Turn the power off, and on again to operate after check.</p>
P2	<p><b>Pipe temperature thermistor/liquid (TH2)</b></p> <p>① The unit is in 3-minute resume prevention mode if short/open of thermistor is detected. Abnormal if the unit does not reset normally after 3 minutes. (The unit returns to normal operation, if it has been reset normally.)</p> <p>② Constantly detected during cooling, drying, and heating (except defrosting) operation Short: 90°C [194°F] or more Open: -40°C [-40°F] or less</p>	<p>① Defective thermistor characteristics</p> <p>② Contact failure of connector (CN44) on the indoor controller board (Insert failure)</p> <p>③ Breaking of wire or contact failure of thermistor wiring</p> <p>④ Defective refrigerant circuit is causing thermistor temperature of 90°C [194°F] or more, or -40°C [-40°F] or less.</p> <p>⑤ Defective indoor controller board</p>	<p>①–③ Check resistance value of thermistor. For characteristics, refer to (P1) above.</p> <p>② Check contact failure of connector (CN44) on the indoor controller board. Refer to "9-7. TEST POINT DIAGRAM". Turn the power on and check restart after inserting connector again.</p> <p>④ Check pipe &lt;liquid&gt; temperature with remote controller in test run mode. If pipe &lt;liquid&gt; temperature is extremely low (in cooling mode) or high (in heating mode), refrigerant circuit may have defective.</p> <p>⑤ Check pipe &lt;liquid&gt; temperature with remote controller in test run mode. If there is extremely difference with actual pipe &lt;liquid&gt; temperature, replace indoor controller board.</p> <p>Turn the power off, and on again to operate after check.</p>
P4	<p><b>Contact failure of drain float switch (CN4F)</b></p> <ul style="list-style-type: none"> <li>Extract when the connector of drain float switch is disconnected. (③ and ④ of connector CN4F is not short-circuited.)</li> <li>Constantly detected during operation</li> </ul>	<p>① Contact failure of connector (Insert failure)</p> <p>② Defective indoor controller board</p>	<p>① Check contact failure of float switch connector. Turn the power on again and check after inserting connector again.</p> <p>② Operate with connector (CN4F) short-circuited. Replace indoor controller board if abnormality reappears.</p>
P5	<p><b>Drain over flow protection operation</b></p> <p>① Suspensive abnormality, if drain float switch is detected to be underwater for 1 minute and 30 seconds continuously with drain pump on. Compressor and indoor fan will be turned off.</p> <p>② Drain pump is abnormal if the condition above is detected during suspensive abnormality.</p> <p>③ Constantly detected during drain pump operation</p>	<p>① Malfunction of drain pump</p> <p>② Defective drain Clogged drain pump Clogged drain pipe</p> <p>③ Defective drain float switch Catch of drain float switch or malfunction of moving parts cause drain float switch to be detected under water (Switch On)</p> <p>④ Defective indoor-controller board</p>	<p>① Check if drain-up machine works.</p> <p>② Check drain function.</p> <p>③ Remove drain float switch connector CN4F and check if it is short (Switch On) with the moving part of float switch UP, or OPEN with the moving part of float switch down. Replace float switch if it is short with the moving part of float switch down.</p> <p>④ Replace indoor controller board if it is short-circuited between ③–④ of the drain float switch connector CN4F and abnormality reappears.</p> <p>It is not abnormal if there is no problem about the above-mentioned ①–④. Turn the power off, and on again to operate after check.</p>

Check code	Abnormal point and detection method	Cause	Countermeasure
P6	<p><b>Freezing/overheating protection is working</b></p> <p>① Freezing protection (Cooling mode) The unit is in 6-minute resume prevention mode if pipe &lt;liquid or condenser/evaporator&gt; temperature stays under <math>-15^{\circ}\text{C}</math> [<math>5^{\circ}\text{F}</math>] for 3 minutes, 3 minutes after the compressor started. Abnormal if it stays under <math>-15^{\circ}\text{C}</math> [<math>5^{\circ}\text{F}</math>] for 3 minutes again within 16 minutes after 6-minute resume prevention mode.</p> <p>② Overheating protection (Heating mode) The unit is in 6-minute resume prevention mode if pipe &lt;liquid or condenser/evaporator&gt; temperature is detected as over <math>70^{\circ}\text{C}</math> [<math>158^{\circ}\text{F}</math>] after the compressor started. Abnormal if the temperature of over <math>70^{\circ}\text{C}</math> [<math>158^{\circ}\text{F}</math>] is detected again within 30 minutes after 6-minute resume prevention mode.</p>	<p>(Cooling or drying mode)</p> <p>① Clogged filter (reduced airflow) ② Short cycle of air path ③ Low-load (low temperature) operation out of the tolerance range ④ Defective indoor fan motor • Fan motor is defective. • Indoor controller board is defective. ⑤ Defective outdoor fan control ⑥ Overcharge of refrigerant ⑦ Defective refrigerant circuit (clogs)</p> <p>(Heating mode)</p> <p>① Clogged filter (reduced airflow) ② Short cycle of air path ③ Over-load (high temperature) operation out of the tolerance range ④ Defective indoor fan motor • Fan motor is defective. • Indoor controller board is defective. ⑤ Defective outdoor fan control ⑥ Overcharge of refrigerant ⑦ Defective refrigerant circuit (clogs) ⑧ Bypass circuit of outdoor unit is defective.</p>	<p>(Cooling or drying mode)</p> <p>① Check clogs of the filter. ② Remove shields.</p> <p>④ Refer to "9-6. HOW TO CHECK THE PARTS".</p> <p>⑤ Check outdoor fan motor. ⑥⑦ Check operating condition of refrigerant circuit.</p> <p>(Heating mode)</p> <p>① Check clogs of the filter. ② Remove shields.</p> <p>④ Refer to "9-6. HOW TO CHECK THE PARTS".</p> <p>⑤ Check outdoor fan motor. ⑥-⑧ Check operating condition of refrigerant circuit.</p>
P8	<p><b>Pipe temperature</b> &lt;Cooling mode&gt; Detected as abnormal when the pipe temperature is not in the cooling range 3 minutes after compressor start and 6 minutes after the liquid or condenser/evaporator pipe is out of cooling range. Note 1: It takes at least 9 minutes to detect. Note 2: Abnormality P8 is not detected in drying mode. Cooling range: <math>-3^{\circ}\text{C}</math> [<math>-5.4^{\circ}\text{F}</math>] <math>\geq</math> (TH-TH1) TH: Lower temperature between liquid pipe temperature (TH2) and condenser/evaporator temperature (TH5) TH1: Intake temperature</p> <p>&lt;Heating mode&gt; When 10 seconds have passed after the compressor starts operation and the hot adjustment mode has finished, the unit is detected as abnormal when condenser/evaporator pipe temperature is not in heating range within 20 minutes.</p> <p>Note 3: It takes at least 27 minutes to detect abnormality. Note 4: It excludes the period of defrosting. (Detection restarts when defrosting mode is over.) Heating range: <math>3^{\circ}\text{C}</math> [<math>5.4^{\circ}\text{F}</math>] <math>\leq</math> (TH5-TH1)</p>	<p>① Slight temperature difference between indoor room temperature and pipe &lt;liquid or condenser/evaporator&gt; temperature thermistor • Shortage of refrigerant • Disconnected holder of pipe &lt;liquid or condenser/evaporator&gt; thermistor • Defective refrigerant circuit</p> <p>② Converse connection of extension pipe (on plural units connection) ③ Converse wiring of indoor/outdoor unit connecting wire (on plural units connection) ④ Defective detection of indoor room temperature and pipe &lt;condenser/evaporator&gt; temperature thermistor ⑤ Stop valve is not opened completely.</p>	<p>①-④ Check pipe &lt;liquid or condenser/evaporator&gt; temperature with room temperature display on remote controller and outdoor controller circuit board. Pipe &lt;liquid or condenser/evaporator&gt; temperature display is indicated by setting SW2 of outdoor controller circuit board as follows.</p> <p>(Conduct temperature check with outdoor controller circuit board after connecting 'A-Control Service Tool(PAC-SK52ST)').</p> <p>②③ Check converse connection of extension pipe or converse wiring of indoor/outdoor unit connecting wire.</p>

Check code	Abnormal point and detection method	Cause	Countermeasure
P9	<p><b>Condenser/evaporator temperature thermistor (TH5)</b></p> <p>① The unit is in 3-minute resume protection mode if short/open of thermistor is detected. Abnormal if the unit does not get back to normal within 3 minutes. (The unit returns to normal operation, if it has been reset normally.)</p> <p>② Constantly detected during cooling, drying, and heating operation (except defrosting) Short: 90°C [194°F] or more Open: -40°C [-40°F] or less</p>	<p>① Defective thermistor characteristics</p> <p>② Contact failure of connector (CN44) on the indoor controller board (Insert failure)</p> <p>③ Breaking of wire or contact failure of thermistor wiring</p> <p>④ Temperature of thermistor is 90°C [194°F] or more or -40°C [-40°F] or less caused by defective refrigerant circuit.</p> <p>⑤ Defective indoor controller board</p>	<p>①-③ Check resistance value of thermistor. For characteristics, refer to (P1) above.</p> <p>② Check contact failure of connector (CN44) on the indoor controller board. Refer to "9-7. TEST POINT DIAGRAM". Turn the power on and check restart after inserting connector again.</p> <p>④ Operate in test run mode and check pipe &lt;condenser/evaporator&gt; temperature with outdoor controller circuit board. If pipe &lt;condenser/evaporator&gt; temperature is extremely low (in cooling mode) or high (in heating mode), refrigerant circuit may have defect.</p> <p>⑤ Operate in test run mode and check pipe &lt;condenser/evaporator&gt; temperature with outdoor control circuit board. If there is extreme difference with actual pipe &lt;condenser/evaporator&gt; temperature, replace indoor controller board. There is no abnormality if none of above comes within the unit. Turn the power off and on again to operate.</p> <p>( In case of checking pipe temperature with outdoor controller circuit board, be sure to connect A-control service tool (PAC-SK52ST). )</p>
PA	<p><b>Forced compressor stop (due to water leakage abnormality)</b></p> <p>① The unit has a water leakage abnormality when the following conditions, a) and b), are satisfied while the above-mentioned detection is performed.</p> <p>a) The intake temperature subtracted with liquid pipe temperature detects to be less than -10°C [14°F] for a total of 30 minutes. (When the drain sensor is detected to be NOT soaked in the water, the detection record of a) and b) will be cleared.)</p> <p>b) Drain float switch detects to be in the water for more than 15 minutes.</p> <p>Note: Once the water leakage abnormality is detected, abnormality state will not be released until the main power is reset.</p>	<p>① Drain pump trouble</p> <p>② Drain defective · Drain pump clogging · Drain pipe clogging</p> <p>③ Open circuit of float switch</p> <p>④ Contact failure of float switch connector</p> <p>⑤ Dew condensation on float switch · Drain water descends along lead wire. · Drain water is waving due to filter clogging.</p> <p>⑥ Extension piping connection difference at twin, triple or quadruple system</p> <p>⑦ Miswiring of indoor/outdoor connecting at twin, triple or quadruple system</p> <p>⑧ Room temperature thermistor/ liquid pipe temperature thermistor detection is defective.</p>	<p>① Check the drain pump.</p> <p>② Check whether water can be drained.</p> <p>③ Check the resistance of the float switch.</p> <p>④ Check the connector contact failure.</p> <p>⑤ Check the float switch leadwire mounted. Check the filter clogging.</p> <p>⑥ Check the piping connection.</p> <p>⑦ Check the indoor/outdoor connecting wires.</p> <p>⑧ Check the room temperature display of remote controller. Check the indoor liquid pipe temperature display of outdoor controller board.</p>
PB (Pb)	<p><b>Fan motor trouble</b></p>	<p>① Defective fan motor</p> <p>② Defective indoor controller board</p> <p>③ Contact failure of fan motor connector</p>	<p>①-③ Refer to "9-6-2. DC fan motor (fan motor/indoor controller circuit board)".</p>
E0 or E4	<p><b>Remote controller transmission error(E0)/signal receiving error(E4)</b></p> <p>① Abnormal if main or sub remote controller cannot receive any transmission normally from indoor unit of refrigerant address "0" for 3 minutes. (Check code: E0)</p> <p>② Abnormal if sub remote controller could not receive any signal for 2 minutes. (Check code: E0)</p> <p>① Abnormal if indoor controller board can not receive any data normally from remote controller board or from other indoor controller board for 3 minutes. (Check code: E4)</p> <p>② Indoor controller board cannot receive any signal from remote controller for 2 minutes. (Check code: E4)</p>	<p>① Contact failure at transmission wire of remote controller</p> <p>② All remote controllers are set as "sub" remote controller. In this case, E0 is displayed on remote controller, and E4 is displayed at LED (LED1, LED2) on the outdoor controller circuit board.</p> <p>③ Miswiring of remote controller</p> <p>④ Defective transmitting receiving circuit of remote controller</p> <p>⑤ Defective transmitting receiving circuit of indoor controller board of refrigerant addresses "0".</p> <p>⑥ Noise has entered into the transmission wire of remote controller.</p>	<p>① Check disconnection or looseness of indoor unit or transmission wire of remote controller.</p> <p>② Set one of the remote controllers "main" if there is no problem with the action above.</p> <p>③ Check wiring of remote controller. · Total wiring length: max. 500 m (Do not use cables with 3 cores or more. Do not use shielded wires.) · The number of connecting indoor units: max. 16 units · The number of connecting remote controller: max. 2 units When two units are connected, the total wiring length shall not exceed 200 m.</p> <p>If the cause of trouble is not in above ①-③,</p> <p>④ Diagnose remote controllers. a) When "OK" is displayed, remote controllers have no problem. Turn the power off, and on again to check. If abnormality generates again, replace indoor controller board. b) When "NG" is displayed, replace remote controller. c) When "E3" or "ERC" is displayed, noise may be causing abnormality.</p> <p>Note: If the unit is not normal after replacing indoor controller board in group control, indoor controller board of address "0" may be abnormal.</p>

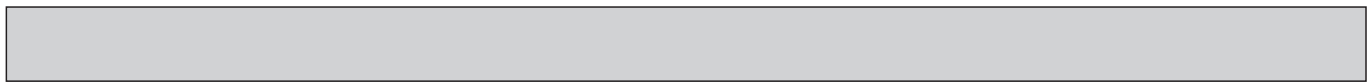

Check code	Abnormal point and detection method	Cause	Countermeasure
E3 or E5	<p><b>Remote controller transmission error(E3)/signal receiving error(E5)</b></p> <p>① Abnormal if remote controller could not find blank of transmission path for 6 seconds and could not transmit. (Check code: E3)</p> <p>② Remote controller receives transmitted data at the same time and compares the received and transmitted data. Abnormal if these data are judged to be different 30 continuous times. (Check code: E3)</p> <p>① Abnormal if indoor controller board could not find blank of transmission path. (Check code: E5)</p> <p>② Indoor controller board receives transmitted data at the same time and compares the received and transmitted data. Abnormal if these data are judged to be different 30 continuous times. (Check code: E5)</p>	<p>① 2 remote controllers are set as "main." (In case of 2 remote controllers)</p> <p>② Remote controller is connected with 2 indoor units or more.</p> <p>③ Repetition of refrigerant address</p> <p>④ Defective transmitting receiving circuit of remote controller</p> <p>⑤ Defective transmitting receiving circuit of indoor controller board</p> <p>⑥ Noise has entered into transmission wire of remote controller.</p>	<p>① Set a remote controller to main, and the other to sub.</p> <p>② Remote controller is connected with only one indoor unit.</p> <p>③ The address changes to a separate setting.</p> <p>④-⑥ Diagnose remote controller.</p> <p>a) When "OK" is displayed, remote controllers have no problem. Turn the power off, and on again to check. When becoming abnormal again, replace indoor controller board.</p> <p>b) When "NG" is displayed, replace remote controller.</p> <p>c) When "E3" or "ERC" is displayed, noise may be causing abnormality.</p>
E6	<p><b>Indoor/outdoor unit communication error (Signal receiving error)</b></p> <p>① Abnormal if indoor controller board cannot receive any signal normally for 6 minutes after turning the power on.</p> <p>② Abnormal if indoor controller board cannot receive any signal normally for 3 minutes.</p> <p>③ Consider the unit abnormal under the following condition: When 2 or more indoor units are connected to an outdoor unit, indoor controller board cannot receive a signal for 3 minutes from outdoor controller circuit board, a signal which allows outdoor controller circuit board to transmit signals.</p>	<p>① Contact failure, short circuit or, miswiring (converse wiring) of indoor/outdoor unit connecting wire</p> <p>② Defective transmitting receiving circuit of indoor controller board</p> <p>③ Defective transmitting receiving circuit of indoor controller board</p> <p>④ Noise has entered into indoor/outdoor unit connecting wire.</p>	<p>Check LED display on the outdoor control circuit board. (Connect A-control service tool, PAC-SK52ST.) Refer to outdoor unit service manual.</p> <p>① Check disconnection or looseness of indoor/ outdoor unit connecting wire of indoor unit or outdoor unit. Check all the units in case of twin triple indoor unit system.</p> <p>②-④ Turn the power off, and on again to check. If abnormality generates again, replace indoor controller board or outdoor controller circuit board.</p> <p>Note: Other indoor controller board may have defect in the case of twin triple indoor unit system.</p>
E7	<p><b>Indoor/outdoor unit communication error (Transmitting error)</b></p> <p>Abnormal if "1" receiving is detected 30 times continuously though indoor controller board has transmitted "0".</p>	<p>① Defective transmitting receiving circuit of indoor controller board</p> <p>② Noise has entered into power supply.</p> <p>③ Noise has entered into outdoor control wire.</p>	<p>①-③ Turn the power off, and on again to check. If abnormality generates again, replace indoor controller board.</p>
FB (Fb)	<p><b>Indoor controller board</b></p> <p>Abnormal if data cannot be read normally from the nonvolatile memory of the indoor controller board.</p>	<p>① Defective indoor controller board</p>	<p>① Replace indoor controller board.</p>
E1 or E2	<p><b>Remote controller control board</b></p> <p>① Abnormal if data cannot be read normally from the nonvolatile memory of the remote controller control board. (Check code: E1)</p> <p>② Abnormal if the clock function of remote controller cannot be operated normally. (Check code: E2)</p>	<p>① Defective remote controller</p>	<p>① Replace remote controller.</p>
PL	<p><b>Abnormal refrigerant circuit</b></p> <p>During Cooling, Drying, or Auto Cooling operation, the following conditions are regarded as failures when detected for 1 second.</p> <p>a)The compressor continues to run for 30 or more seconds.</p> <p>b)The liquid pipe temperature or the condenser/evaporator temperature is 75°C [167°F] or more.</p> <p><b><u>These detected errors will not be cancelled until the power source is reset.</u></b></p>	<p>① Abnormal operation of 4-way valve</p> <p>② Disconnection of or leakage in refrigerant pipes</p> <p>③ Air into refrigerant piping</p> <p>④ Abnormal operation (no rotation) of indoor fan</p> <ul style="list-style-type: none"> <li>· Defective fan motor</li> <li>· Defective indoor control board</li> </ul> <p>⑤ Defective refrigerant circuit (clogging)</p>	<p>① <b><u>When this error occurs, be sure to replace the 4-way valve.</u></b></p> <p>② Check refrigerant pipes for disconnection or leakage.</p> <p>③ After the recovery of refrigerant, vacuum dry the whole refrigerant circuit.</p> <p>④ Refer to "9-6-2. DC fan motor (fan motor/ indoor controller circuit board)".</p> <p>⑤ Check refrigerant circuit for operation.</p> <p><b><u>To avoid entry of moisture or air into refrigerant circuit which could cause abnormal high pressure, purge air in refrigerant circuit or replace refrigerant.</u></b></p>

## 9-4. TROUBLESHOOTING OF PROBLEMS

Note: Refer to the outdoor unit's service manual for the detail of remote controller.

Phenomena	Cause	Countermeasure
(1)LED2 on indoor controller board is off.	<ul style="list-style-type: none"> <li>• When LED1 on indoor controller board is also off.</li> </ul> <p>① Power supply of rated voltage is not supplied to outdoor unit.</p> <p>② Defective outdoor controller circuit board</p> <p>③ Power supply of 208/230 V is not supplied to indoor unit.</p> <p>④ Defective indoor controller board</p>	<p>① Check the voltage of outdoor power supply terminal block (L1, L2).</p> <ul style="list-style-type: none"> <li>• When 208/230 VAC is not detected, check the power wiring to outdoor unit and the breaker.</li> <li>• When 208/230 VAC is detected, check ② (below).</li> </ul> <p>② Check the voltage between outdoor terminal block S1 and S2.</p> <ul style="list-style-type: none"> <li>• When 208/230 VAC is not detected, —check the fuse on outdoor controller circuit board.</li> <li>—check the wiring connection.</li> <li>• When 208/230 VAC is detected, check ③ (below).</li> </ul> <p>③ Check the voltage between indoor terminal block S1 and S2.</p> <ul style="list-style-type: none"> <li>• When 208/230 VAC is not detected, check indoor/outdoor unit connecting wire for miswiring.</li> <li>• When 208/230 VAC is detected, check ④ (below).</li> </ul> <p>④ Check the fuse on indoor controller board. Check the wiring connection. If no problem is found, indoor controller board is defective.</p>
	<ul style="list-style-type: none"> <li>• When LED1 on indoor controller board is lit.</li> </ul> <p>① Mis-setting of refrigerant address for outdoor unit (There is no unit corresponding to refrigerant address "0".)</p>	<p>① Check again the setting of refrigerant address for outdoor unit. Set the refrigerant address to "0". (For grouping control system under which 2 or more outdoor units are connected, set one of the units to "0".) Set refrigerant address using SW1 (3-6) on outdoor controller circuit board.</p>
(2)LED2 on indoor controller board is blinking.	<ul style="list-style-type: none"> <li>• When LED1 on indoor controller board is also blinking.</li> </ul> <p>① Connection failure of indoor/outdoor unit connecting wire</p> <ul style="list-style-type: none"> <li>• When LED1 is lit.</li> </ul> <p>① Miswiring of remote controller wires Under twin or triple indoor unit system, 2 or more indoor units are wired together.</p> <p>② Refrigerant address for outdoor unit is wrong or not set. Under grouping control system, there are some units whose refrigerant addresses are 0.</p> <p>③ Short-circuit of remote controller wires</p> <p>④ Defective remote controller</p>	<p>① Check indoor/outdoor unit connecting wire for connection failure.</p> <p>① Check the connection of remote controller wires in case of twin triple indoor unit system. When 2 or more indoor units are wired in one refrigerant system, connect remote controller wires to one of those units.</p> <p>② Check the setting of refrigerant address in case of grouping control system. If there are some units whose refrigerant addresses are 0 in one group, set one of the units to 0 using SW1 (3-6) on outdoor controller circuit board.</p> <p>③④ Remove remote controller wires and check LED2 on indoor controller board.</p> <ul style="list-style-type: none"> <li>• When LED2 is blinking, check the short-circuit of remote controller wires.</li> <li>• When LED2 is lit, connect remote controller wires again and: if LED2 is blinking, remote controller is defective; if LED2 is lit, connection failure of remote controller terminal block, etc. has returned to normal.</li> </ul>

Note: Refer to the outdoor unit's service manual for the detail of remote controller.

Phenomena	Cause	Countermeasure
<b>(3)Upward/downward vane performance failure</b>	① The vane is not downward during defrosting and heat preparation and when the thermostat is OFF in HEAT mode. (Working of COOL protection function) ② Vane motor does not rotate. • Defective vane motor • Breaking of wire or connection failure of connector  ③ Upward/downward vane does not work. • The vane is set to fixed position.	① Normal operation (The vane is set to horizontal regardless of remote control.)  ② Check ② (left). • Check the vane motor. (Refer to 9-6. HOW TO CHECK THE PARTS.) • Check for breaking of wire or connection failure of connector.  ③ Normal operation (Each connector on vane motor side is disconnected or setting the fixed vanes by wired remote controller.)
<b>(4)Receiver for wireless remote controller</b>	① Weak batteries of wireless remote controller  ② Contact failure of connector (CNB) on wireless remote controller board (Insert failure) ③ Contact failure of connector (CN90) on indoor controller board (Insert failure) ④ Contact failure of connector between wireless remote controller board and indoor controller board	① Replace batteries of wireless remote controller.  ②-④ Check contact failure of each connector. If no problems are found of connector, replace indoor controller board. When the same trouble occurs even if indoor controller board is replaced, replace wireless remote controller board.

## 9-5. EMERGENCY OPERATION

### 9-5-1. When wireless remote controller fails or its battery is exhausted

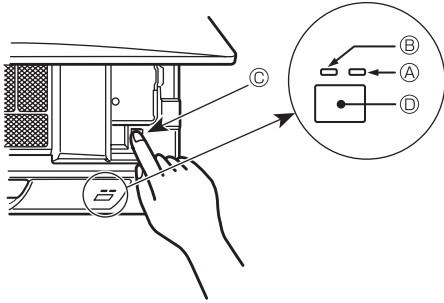

#### When the remote controller cannot be used

When the batteries of the remote controller run out or the remote controller malfunctions, the emergency operation can be done using the emergency buttons.

- Ⓐ DEFROST/STAND BY lamp (ORANGE)
- Ⓑ Operation lamp (GREEN)
- Ⓒ Emergency operation switch (cooling/heating)
- Ⓓ Receiver

- Each press of the emergency operation switch will toggle the operation mode.
- Check "COOL/HEAT" with the operation monitor display. (The display will appear orange for 5 seconds after pressing the emergency operation switch.)

#### [Heat pump type]



#### [Cooling Only type]

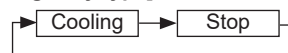

#### Operation Monitor Display

	GREEN	ORANGE	
STOP	OFF	OFF	The orange lamp follows the switch operation as indicated at the left for 5 seconds, and then it will return to the normal display.
COOL	ON	OFF	
HEAT	ON	ON	

Details of emergency mode are as shown below.

Operation Mode	COOL	HEAT
Set Temperature	24°C [75°F]	24°C [75°F]
Fan Speed	High	High
Airflow Direction Up and Down	Horizontal	Downward

### 9-5-2. When wired remote controller or indoor unit microprocessor fails

1. When the wired remote controller or the indoor unit microcomputer has failed, but all other components work properly, if you set the switch (SWE) on the indoor controller board ON, the indoor unit will begin Emergency Operation.

When Emergency Operation is activated, the indoor unit operates as follows:

- (1) Indoor fan is running at high speed. (2) Drain pump is working. (option)

\*Note on the wireless remote control:

When the remote control does not function, it is possible to activate Emergency Operation by using the indoor unit Emergency Operation switch.

However, if the indoor unit microprocessor has failed, it is necessary to proceed with points 2 and 3 below as in the case of the wired remote control.

2. When you activate Emergency Operation of the cooling or heating, you have to set the switch (SWE) on the indoor controller board and activate Emergency Operation of the outdoor unit.

For details on how to activate Emergency Operation of the outdoor unit, refer to the outdoor unit wiring diagram.

3. Before you activate Emergency Operation, check the following points:

- (1) Emergency operation cannot be activated when:

- the outdoor unit malfunctions.
- the indoor fan malfunctions.
- when it has detected the malfunction of drain pump during self-diagnosing.

- (2) Emergency Operation becomes continuous only by switching the power source on/off.

ON/OFF on the remote control or temperature control etc. does not function.

- (3) Avoid operating for a long time when the outdoor unit begins defrosting while Emergency Operation of the heating is activated, because it will start to blow cold air.

- (4) Emergency cooling should be limited to 10 hours maximum (The indoor unit heat exchanger may freeze).

- (5) After Emergency Operation has been deactivated, set the switches etc. to their original positions.

- (6) Movement of the vanes does not work in Emergency Operation, therefore you have to slowly set them manually to the appropriate position.

## 9-6. HOW TO CHECK THE PARTS

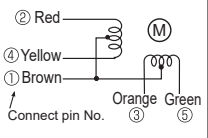
Parts name	Checkpoints														
Room temperature thermistor (TH1) Pipe temperature thermistor/liquid (TH2) Condenser/evaporator temperature thermistor (TH5)	Disconnect the connector then measure the resistance using a multimeter. (At the ambient temperature 10 to 30°C [50 to 86°F]) <table border="1" style="margin: 10px auto;"> <thead> <tr> <th>Normal</th> <th>Abnormal</th> </tr> </thead> <tbody> <tr> <td>4.3 to 9.6 kΩ</td> <td>Open or short</td> </tr> </tbody> </table> Refer to "9-6-1. Thermistor".	Normal	Abnormal	4.3 to 9.6 kΩ	Open or short										
Normal	Abnormal														
4.3 to 9.6 kΩ	Open or short														
Vane motor (MV) 	Measure the resistance between the terminals using a multimeter. (Coil temperature 68°F) <table border="1" style="margin: 10px auto;"> <thead> <tr> <th colspan="4">Normal</th> <th>Abnormal</th> </tr> </thead> <tbody> <tr> <td>①-② Brown-Red</td> <td>①-③ Brown-Orange</td> <td>①-④ Brown-Yellow</td> <td>①-⑤ Brown-Green</td> <td rowspan="2">Open or short</td> </tr> <tr> <td colspan="4" style="text-align: center;">250 Ω ± 7%</td> </tr> </tbody> </table>	Normal				Abnormal	①-② Brown-Red	①-③ Brown-Orange	①-④ Brown-Yellow	①-⑤ Brown-Green	Open or short	250 Ω ± 7%			
Normal				Abnormal											
①-② Brown-Red	①-③ Brown-Orange	①-④ Brown-Yellow	①-⑤ Brown-Green	Open or short											
250 Ω ± 7%															
Fan motor (MF)	Refer to "9-6-2. DC Fan Motor (fan motor/indoor controller circuit board)".														

### 9-6-1. Thermistor

<Thermistor characteristic graph>

**Thermistors for lower temperature**

Room temperature thermistor (TH1)  
Pipe temperature thermistor/liquid (TH2)  
Condenser/evaporator temperature thermistor (TH5)

Thermistor  $R_0 = 15 \text{ k}\Omega \pm 3\%$   
Fixed number of  $B = 3480 \pm 2\%$

$t(^{\circ}\text{C}) \dots R_t (\text{k}\Omega) = R_0 \exp\left\{ B \left( \frac{1}{273+t} - \frac{1}{273} \right) \right\}$

$T(^{\circ}\text{F}) \dots R_T (\text{k}\Omega) = R_0 \exp\left\{ B \left( \frac{1}{273 + \frac{T-32}{1.8}} - \frac{1}{273} \right) \right\}$

0°C	[32°F]	15 kΩ
10°C	[50°F]	9.6 kΩ
20°C	[68°F]	6.3 kΩ
25°C	[77°F]	5.4 kΩ
30°C	[86°F]	4.3 kΩ
40°C	[104°F]	3.0 kΩ

<Thermistor for lower temperature>

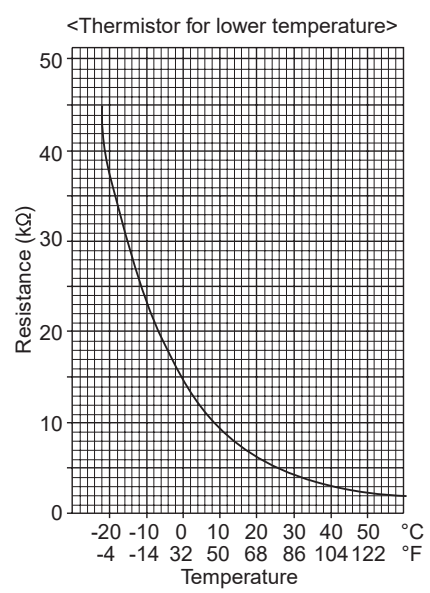

Temperature (°C)	Temperature (°F)	Resistance (kΩ)
-20	-4	45
-10	14	35
0	32	25
10	50	18
20	68	13
30	86	10
40	104	7.5
50	122	6.0



## 9-6-2. DC Fan Motor (fan motor/indoor controller circuit board)

### Check method of DC fan motor (fan motor/indoor controller circuit board)

① Notes

- High voltage is applied to the connector (CNMF) for the fan motor. Pay attention to the service.  
(It causes trouble of the indoor controller circuit board and fan motor.)

② Self check

Symptom : The indoor fan cannot rotate.

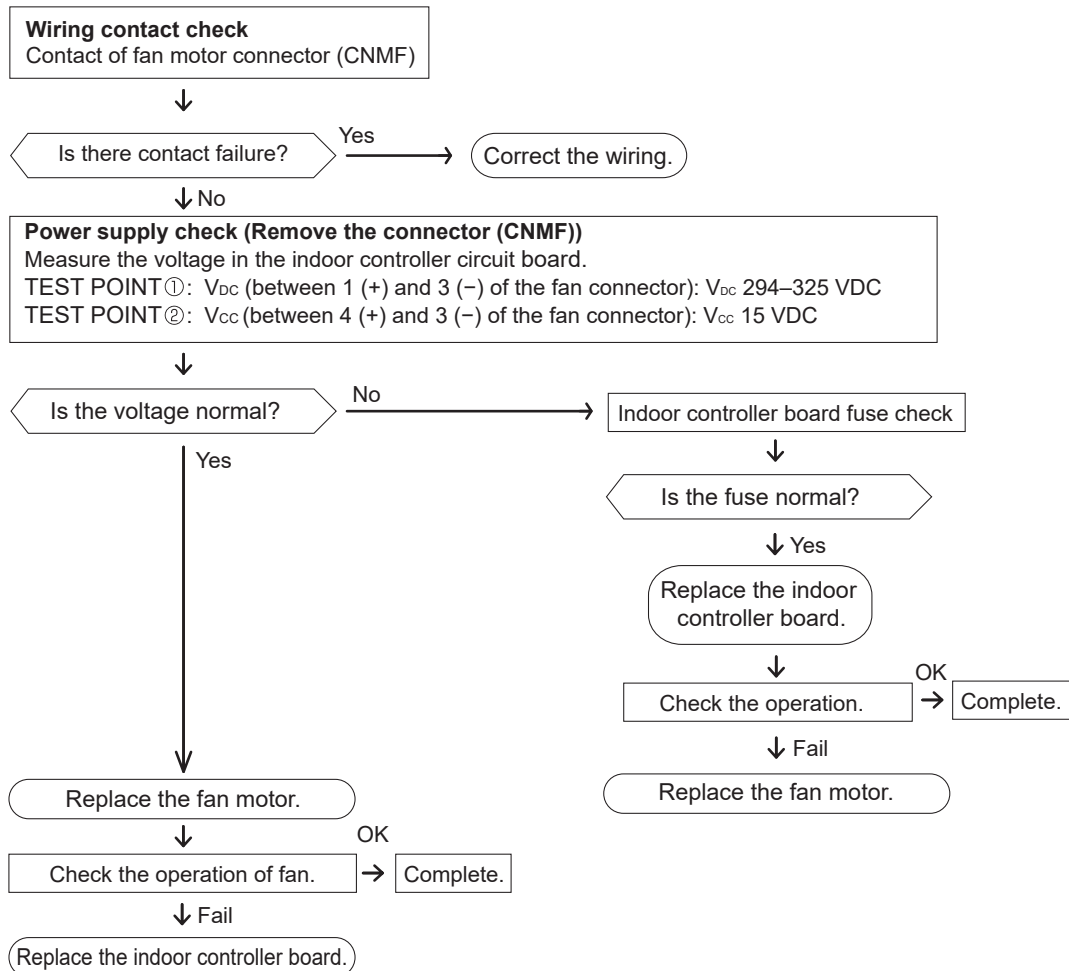

# 9-7. TEST POINT DIAGRAM

## Indoor controller board

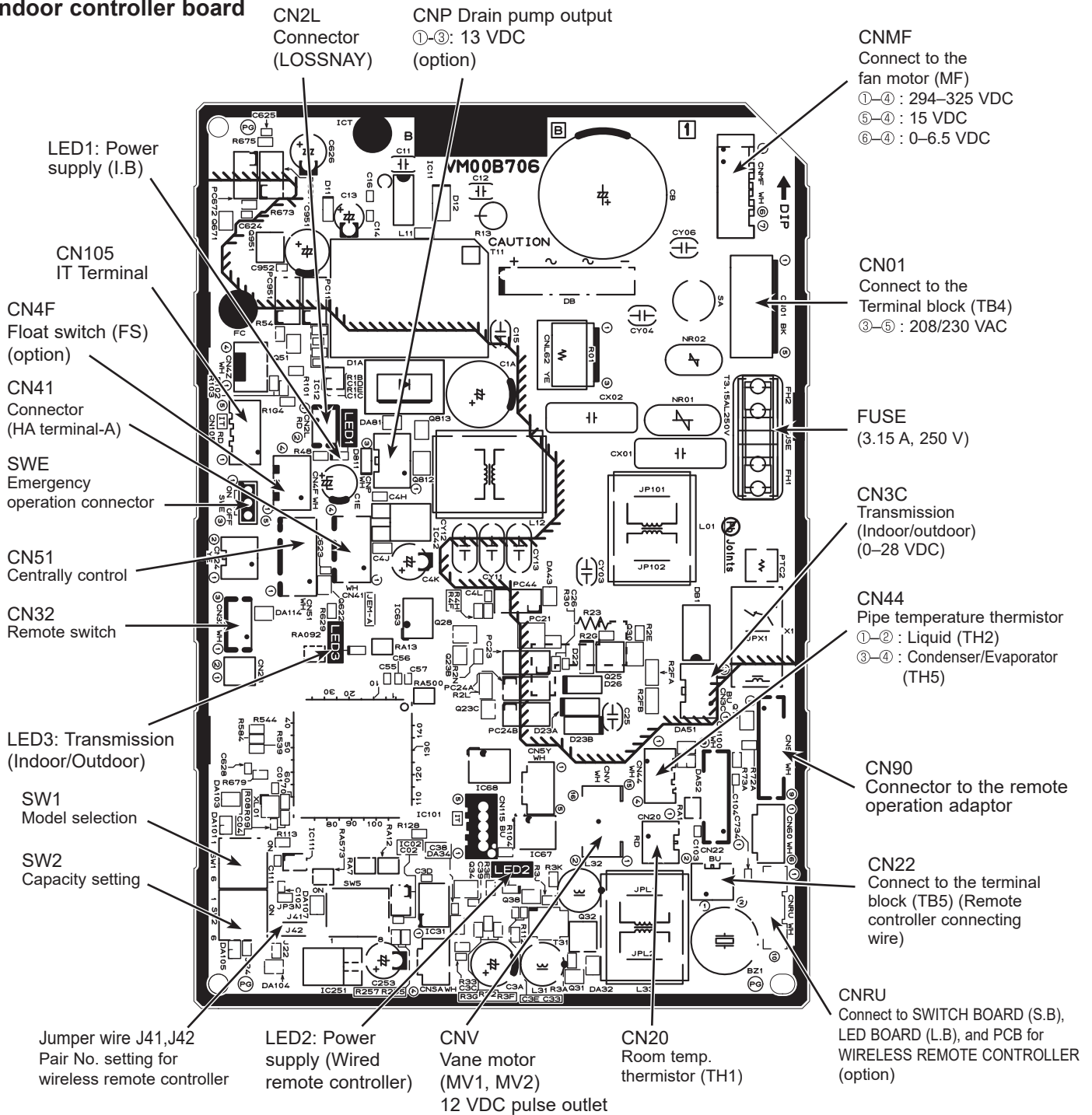

P.C.B. for wireless remote controller(W.B)

Switch board(S.B)

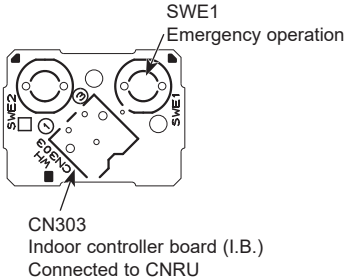
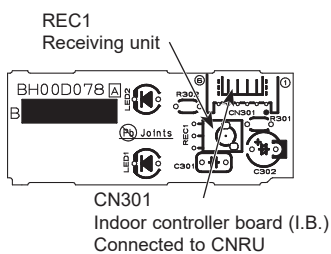

## 9-8. FUNCTIONS OF DIP SWITCH AND JUMPER WIRE

Each function is controlled by the DIP switch and the jumper wire on indoor controller board.

The black square (■) indicates a switch position.

Switch Jumper wire	Functions	Setting by the DIP switch and jumper wire	Remarks																																																																					
SW1	Model settings	<table border="1"> <thead> <tr> <th>MODEL</th> <th>SETTING</th> </tr> </thead> <tbody> <tr> <td>PKA-AK-NL</td> <td> <table border="1"> <tr> <td>1</td><td>2</td><td>3</td><td>4</td><td>5</td><td>6</td> <td>ON OFF</td> </tr> <tr> <td>■</td><td>■</td><td>■</td><td>■</td><td>■</td><td>■</td> <td></td> </tr> </table> </td> </tr> </tbody> </table>	MODEL	SETTING	PKA-AK-NL	<table border="1"> <tr> <td>1</td><td>2</td><td>3</td><td>4</td><td>5</td><td>6</td> <td>ON OFF</td> </tr> <tr> <td>■</td><td>■</td><td>■</td><td>■</td><td>■</td><td>■</td> <td></td> </tr> </table>	1	2	3	4	5	6	ON OFF	■	■	■	■	■	■																																																					
MODEL	SETTING																																																																							
PKA-AK-NL	<table border="1"> <tr> <td>1</td><td>2</td><td>3</td><td>4</td><td>5</td><td>6</td> <td>ON OFF</td> </tr> <tr> <td>■</td><td>■</td><td>■</td><td>■</td><td>■</td><td>■</td> <td></td> </tr> </table>	1	2	3	4	5	6	ON OFF	■	■	■	■	■	■																																																										
1	2	3	4	5	6	ON OFF																																																																		
■	■	■	■	■	■																																																																			
SW2	Capacity settings	<table border="1"> <thead> <tr> <th>MODEL</th> <th>SW2</th> <th>MODEL</th> <th>SW2</th> </tr> </thead> <tbody> <tr> <td>24</td> <td> <table border="1"> <tr> <td>ON</td><td>■</td><td>■</td><td>■</td><td>■</td><td>■</td> </tr> <tr> <td>OFF</td><td>■</td><td>■</td><td>■</td><td>■</td><td>■</td> </tr> <tr> <td></td><td>1</td><td>2</td><td>3</td><td>4</td><td>5</td><td>6</td> </tr> </table> </td> <td>36</td> <td> <table border="1"> <tr> <td>ON</td><td>■</td><td>■</td><td>■</td><td>■</td><td>■</td> </tr> <tr> <td>OFF</td><td>■</td><td>■</td><td>■</td><td>■</td><td>■</td> </tr> <tr> <td></td><td>1</td><td>2</td><td>3</td><td>4</td><td>5</td><td>6</td> </tr> </table> </td> </tr> <tr> <td>30</td> <td> <table border="1"> <tr> <td>ON</td><td>■</td><td>■</td><td>■</td><td>■</td><td>■</td> </tr> <tr> <td>OFF</td><td>■</td><td>■</td><td>■</td><td>■</td><td>■</td> </tr> <tr> <td></td><td>1</td><td>2</td><td>3</td><td>4</td><td>5</td><td>6</td> </tr> </table> </td> <td></td> <td></td> </tr> </tbody> </table>	MODEL	SW2	MODEL	SW2	24	<table border="1"> <tr> <td>ON</td><td>■</td><td>■</td><td>■</td><td>■</td><td>■</td> </tr> <tr> <td>OFF</td><td>■</td><td>■</td><td>■</td><td>■</td><td>■</td> </tr> <tr> <td></td><td>1</td><td>2</td><td>3</td><td>4</td><td>5</td><td>6</td> </tr> </table>	ON	■	■	■	■	■	OFF	■	■	■	■	■		1	2	3	4	5	6	36	<table border="1"> <tr> <td>ON</td><td>■</td><td>■</td><td>■</td><td>■</td><td>■</td> </tr> <tr> <td>OFF</td><td>■</td><td>■</td><td>■</td><td>■</td><td>■</td> </tr> <tr> <td></td><td>1</td><td>2</td><td>3</td><td>4</td><td>5</td><td>6</td> </tr> </table>	ON	■	■	■	■	■	OFF	■	■	■	■	■		1	2	3	4	5	6	30	<table border="1"> <tr> <td>ON</td><td>■</td><td>■</td><td>■</td><td>■</td><td>■</td> </tr> <tr> <td>OFF</td><td>■</td><td>■</td><td>■</td><td>■</td><td>■</td> </tr> <tr> <td></td><td>1</td><td>2</td><td>3</td><td>4</td><td>5</td><td>6</td> </tr> </table>	ON	■	■	■	■	■	OFF	■	■	■	■	■		1	2	3	4	5	6			
MODEL	SW2	MODEL	SW2																																																																					
24	<table border="1"> <tr> <td>ON</td><td>■</td><td>■</td><td>■</td><td>■</td><td>■</td> </tr> <tr> <td>OFF</td><td>■</td><td>■</td><td>■</td><td>■</td><td>■</td> </tr> <tr> <td></td><td>1</td><td>2</td><td>3</td><td>4</td><td>5</td><td>6</td> </tr> </table>	ON	■	■	■	■	■	OFF	■	■	■	■	■		1	2	3	4	5	6	36	<table border="1"> <tr> <td>ON</td><td>■</td><td>■</td><td>■</td><td>■</td><td>■</td> </tr> <tr> <td>OFF</td><td>■</td><td>■</td><td>■</td><td>■</td><td>■</td> </tr> <tr> <td></td><td>1</td><td>2</td><td>3</td><td>4</td><td>5</td><td>6</td> </tr> </table>	ON	■	■	■	■	■	OFF	■	■	■	■	■		1	2	3	4	5	6																															
ON	■	■	■	■	■																																																																			
OFF	■	■	■	■	■																																																																			
	1	2	3	4	5	6																																																																		
ON	■	■	■	■	■																																																																			
OFF	■	■	■	■	■																																																																			
	1	2	3	4	5	6																																																																		
30	<table border="1"> <tr> <td>ON</td><td>■</td><td>■</td><td>■</td><td>■</td><td>■</td> </tr> <tr> <td>OFF</td><td>■</td><td>■</td><td>■</td><td>■</td><td>■</td> </tr> <tr> <td></td><td>1</td><td>2</td><td>3</td><td>4</td><td>5</td><td>6</td> </tr> </table>	ON	■	■	■	■	■	OFF	■	■	■	■	■		1	2	3	4	5	6																																																				
ON	■	■	■	■	■																																																																			
OFF	■	■	■	■	■																																																																			
	1	2	3	4	5	6																																																																		
J41 J42	Pair number setting with wireless remote controller	<table border="1"> <thead> <tr> <th rowspan="2">Wireless remote controller setting</th> <th colspan="2">Control PCB setting</th> </tr> <tr> <th>J41</th> <th>J42</th> </tr> </thead> <tbody> <tr> <td>0</td> <td>Short</td> <td>Short</td> </tr> <tr> <td>1</td> <td>Open</td> <td>Short</td> </tr> <tr> <td>2</td> <td>Short</td> <td>Open</td> </tr> <tr> <td>3-9</td> <td>Open</td> <td>Open</td> </tr> </tbody> </table>	Wireless remote controller setting	Control PCB setting		J41	J42	0	Short	Short	1	Open	Short	2	Short	Open	3-9	Open	Open	<p>&lt;Initial setting&gt;            Wireless remote controller: 0            Control PCB: 0            4 pair number settings are supported.            The pair number settings of the wireless remote controller and indoor control PCB (J41/J42) are given in the table on the left.</p>																																																				
Wireless remote controller setting	Control PCB setting																																																																							
	J41	J42																																																																						
0	Short	Short																																																																						
1	Open	Short																																																																						
2	Short	Open																																																																						
3-9	Open	Open																																																																						

**10-1. UNIT FUNCTION SETTING BY THE REMOTE CONTROLLER**

Each function can be set as necessary using the remote controller. The setting of function for each unit can only be done by the remote controller.

(1) Functions available when setting the unit number to 00

Refer to the service manual that comes with each outdoor unit.

(2) Functions available when setting the unit number to 1-4 or All (07 in case of wireless remote controller)

Mode	Settings	Mode No.	Setting No.	Initial setting	Setting
Filter sign	100 Hr	07	1	○	
	2500 Hr		2		
	No filter sign indicator		3		
Fan speed	Silent (low ceiling)	08	1		
	Standard		2	○	
	High ceiling		3		
Fan speed during the cooling thermostat is OFF	Setting fan speed	27	1	○	
	Stop		2		
	Extra low		3		

## 11-1. ROTATION FUNCTION (AND BACK-UP FUNCTION, 2ND STAGE CUT-IN FUNCTION)

Note that this function is not available for SUZ, MXZ, and PUMY models.

### 11-1-1. Operation

#### (1) Rotation function (and Back-up function)

##### • Outline of functions

- Main and sub units operate according to the interval of rotation setting.
- Main and sub units should be set by refrigerant address. (Outdoor DIP switch setting)
- Refrigerant address "00" → Main unit
- Refrigerant address "01", "02" → Sub unit
- When an error occurs to one unit, another unit will start operation. (Back-up function)

##### • System constraint

- This function is available only by the grouping control system (INDOOR UNIT: OUTDOOR UNIT=1:1) of 2 or 3 refrigerant groups. (Refer to Fig. 1)
- Main indoor unit should be connected for wired remote controller and the transmission line (TB5) for main and sub units should also be connected. (Refer to Fig. 1)
- (This function cannot be set by wireless remote controller.)
- Set refrigerant address of each unit. (DIP switch on the outdoor unit ... Refrigerant address 00/01/02)

#### Operation pattern

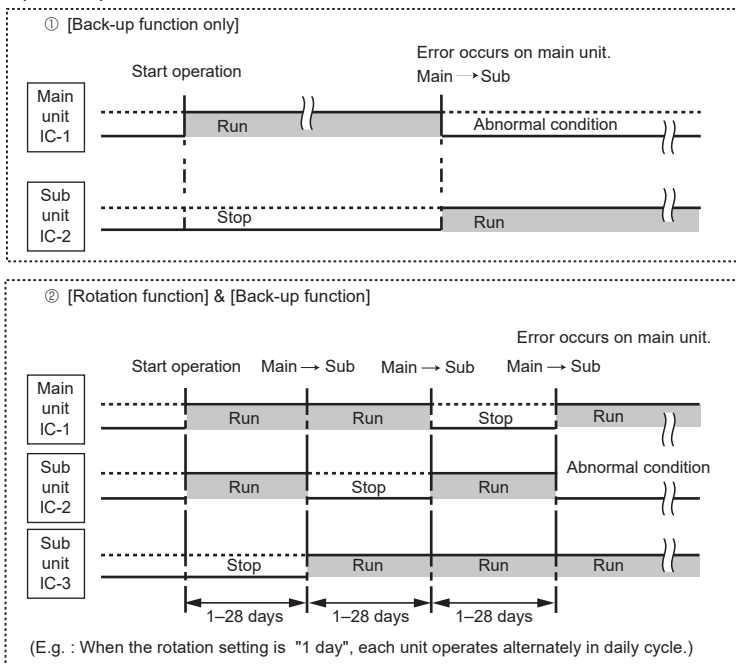
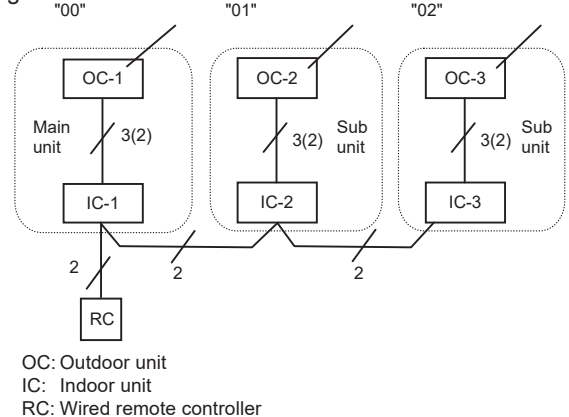

Fig. 1 Refrigerant address "00" Refrigerant address "01" Refrigerant address "02"



#### Note:

- When the unit is restarted to operate after turning off the power or operation OFF status, the unit which was operating will start operation.
- To operate the main units, refer to "13-6. ROTATION SETTING" and set again.

#### (2) 2nd stage cut-in function

##### • Outline of functions

- When the 1st and 2nd units CANNOT supply sufficient capacity for exceptionally high-demand conditions and the actual room temperature reaches set point (\*), the 3rd unit starts operation in conjunction with the 1st and 2nd units.
- Once the actual room temperature goes down to 4°C [8°F] below set point(\*), the 3rd unit stops operation automatically. (\* set point = set temperature by R/C (remote controller) + 4, 6, 8°C [8, 10.8, 14.4°F] (selectable) )
- The number of operating units is determined according to the room temperature and set point.
- When room temperature reaches higher than set point, standby unit starts. (3 units operation)
- When room temperature falls below set point -4°C [-8°F], standby unit stops. (2 units operation)

• **System constraint**

- This function is available only in cool mode.

E.g.) Set temp. by R/C = 20°C [68°F]  
Set point = 26°C [79°F]

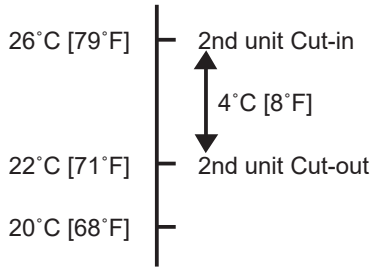

[2nd stage cut-in function]

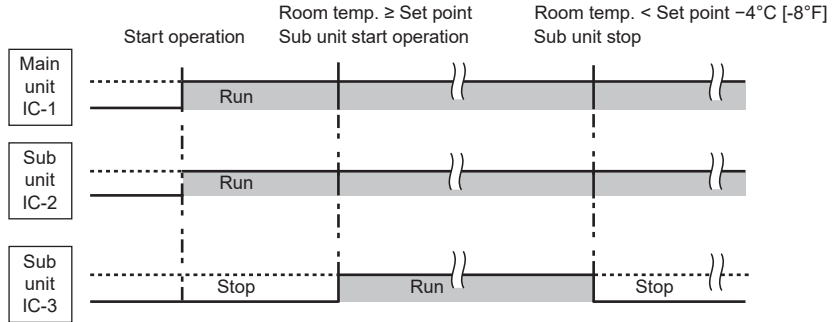

## 11-2. BACK-UP HEATING FUNCTION

### 11-2-1. Operation

The back-up heater turns ON when both of the following conditions have been satisfied:

- A) When the heater ON delay time has passed and the room temperature, which is measured every minute, has not increased three times in a row compared with the temperature before the heater ON delay time started.

Note: The heater ON delay time starts when the condition of “set temperature – room temperature > 0.5°C [1°F]” has been satisfied.

- B) Set temperature – room temperature ≥ 1.5°C [3°F]

The back-up heater turns OFF when the following condition has been satisfied:

- Set temperature – room temperature ≤ 0.5°C [1°F]

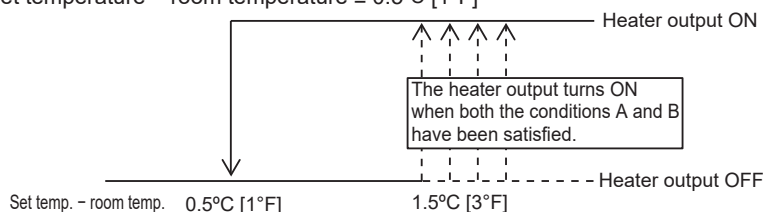

### 11-2-2. How to change the heater ON delay time

You can set these functions by wired remote controller.

Notes:

1. Both main and sub units should be set in the same setting.
2. Every time replacing indoor controller board for service, the function should be set again.
3. Stop the air-conditioner operation before changing the heater ON delay time.

### Request code list

Setting No. (Request code)	Setting contents	Initial setting
No.1 (390)	Monitoring the request code of current setting	
No.2 (391)	10 minutes	
No.3 (392)	15 minutes	
No.4 (393)	20 minutes	○
No.5 (394)	25 minutes	
No.6 (395)	5 minutes	
No.7 (396)	1 minutes	

### 11-2-3. How to connect

When connecting to the connector CN24 of the indoor unit, use PAC-SE56RA-E (optional parts).

————> : Indicates the visible parts in the photos/figures.  
 - - - - -> : Indicates the invisible parts in the photos/figures.

**NOTE:** Turn OFF the power supply before disassembly.  
 Be careful when removing heavy parts.

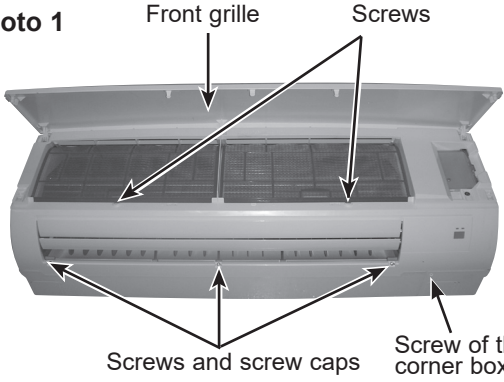
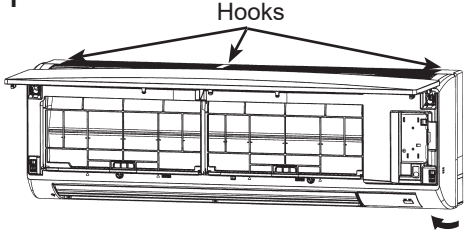
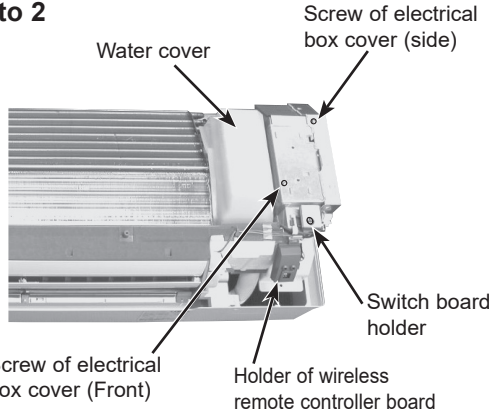
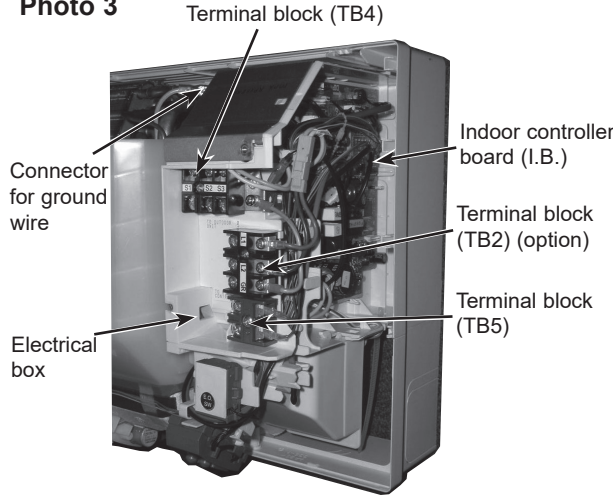
OPERATION PROCEDURE	PHOTOS/FIGURES
<p><b>1. Removing the panel</b></p> <ol style="list-style-type: none"> <li>(1) Press and unlock the knobs on both sides of the front grille and lift the front grille until it is level. Pull the hinges forward to remove the front grille. (See Photo 1)</li> <li>(2) Remove 3 screw caps of the panel. Remove 5 screws. (See Photo 1)</li> <li>(3) Hold the lower part of both ends of the panel and pull it slightly toward you.</li> <li>(4) Unfix 3 hooks (See Figure 1) and then remove the panel by pushing it upward.</li> <li>(5) Remove the screw of the corner box. (See Photo 1) Remove the corner box.</li> </ol>	<p><b>Photo 1</b></p>  <p><b>Figure 1</b></p> 
<p><b>2. Removing the indoor controller board and the wireless controller board</b></p> <ol style="list-style-type: none"> <li>(1) Remove the panel and the corner box. (Refer to step 1)</li> <li>(2) Remove the front and side electrical box covers (each 1 screw). (See Photo 2)</li> <li>(3) Disconnect the connectors on the indoor controller board. (See Photo 3)</li> <li>(4) Remove the switch board holder and open the cover.</li> <li>(5) Pull out the indoor controller board toward you then remove the indoor controller board and switch board. (See Photo 3)</li> <li>(6) Remove the holder of wireless remote controller board.</li> <li>(7) Disconnect the connector of wireless remote controller board and remove the wireless remote controller board from the holder.</li> </ol>	<p><b>Photo 2</b></p>  <p><b>Photo 3</b></p> 



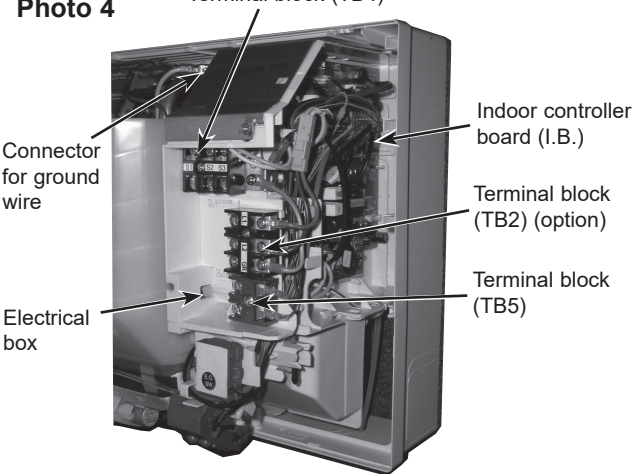
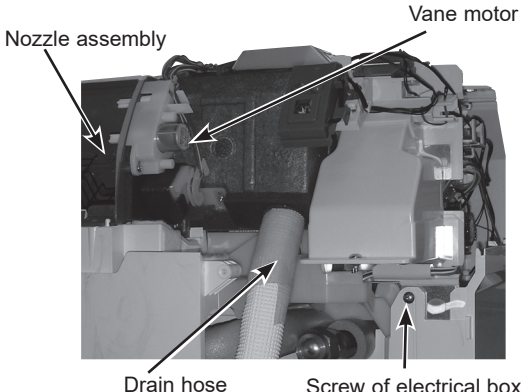
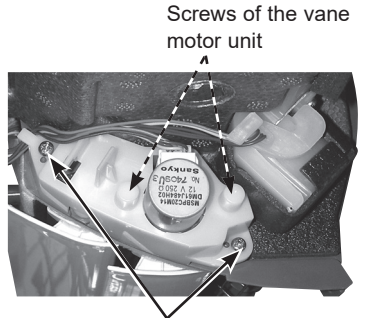

OPERATION PROCEDURE	PHOTOS/FIGURES
<p><b>3. Removing the electrical box</b></p> <ol style="list-style-type: none"><li>(1) Remove the panel and the corner box. (Refer to step 1)</li><li>(2) Remove the front and side electrical box covers (each 1 screw).</li><li>(3) Remove the indoor / outdoor connecting wire from terminal block (TB4).</li><li>(4) Disconnect the connectors on the indoor controller board.</li><li>(5) Disconnect the connector for ground wire.</li><li>(6) Remove the screw on lower side of the electrical box. (See Photo 5)</li><li>(7) Push up the upper fixture catch to remove the box, then remove it from the box fixture.</li></ol>	<p><b>Photo 4</b></p>  <p>Terminal block (TB4)</p> <p>Indoor controller board (I.B.)</p> <p>Terminal block (TB2) (option)</p> <p>Terminal block (TB5)</p> <p>Electrical box</p> <p>Connector for ground wire</p>
<p><b>4. Removing the nozzle assembly (with vane and vane motor) and drain hose</b></p> <ol style="list-style-type: none"><li>(1) Remove the panel and corner box. (Refer to step 1)</li><li>(2) Remove the electrical box covers. (Refer to step 2)</li><li>(3) Disconnect the vane motor connector (CNV) on the indoor controller board.</li><li>(4) Pull out the drain hose from the nozzle assembly, and remove nozzle assembly. (See Photo 5)</li></ol>	<p><b>Photo 5</b> (see the bottom)</p>  <p>Vane motor</p> <p>Nozzle assembly</p> <p>Drain hose</p> <p>Screw of electrical box</p>
<p><b>5. Removing the vane motor</b></p> <ol style="list-style-type: none"><li>(1) Remove the nozzle assembly. (Refer to step 4)</li><li>(2) Remove 2 screws of the vane motor unit cover, and pull out the vane motor unit.</li><li>(3) Remove 2 screws of the vane motor unit.</li><li>(4) Remove the vane motor from the vane motor unit.</li><li>(5) Disconnect the connector from the vane motor.</li></ol>	<p><b>Photo 6</b></p>  <p>Screws of the vane motor unit</p> <p>Screws of the vane motor unit cover</p>

## OPERATION PROCEDURE

### 6. Removing the indoor fan motor and the line flow fan

- (1) Remove the panel and the corner box. (Refer to step 1)
- (2) Remove the electrical box (Refer to step 2) and the nozzle assembly (Refer to step 3).
- (3) Remove the water cut. (See Photo 2)
- (4) Remove the screw fixing the line flow fan. (See Photo 8)
- (5) Remove 5 screws fixing the motor bed. (See Photo 7)
- (6) Remove the lead wire of pipe thermistor from the hook of motor bed. (See Photo 7)
- (7) Remove the screw fixing motor band. (See Photo 7)
- (8) Remove the motor bed together with fan motor and motor band.
- (9) Remove 3 screws fixing the left side of the heat exchanger. (See Photo 9)
- (10) Lift the heat exchanger, and pull out the line flow fan to the lower-left.

**Photo 9**

Screws of the left side of the heat exchanger

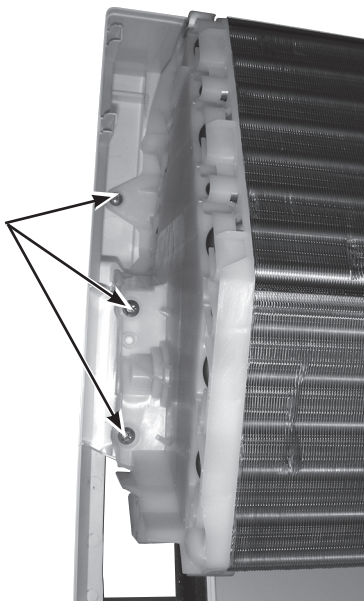

## PHOTOS/FIGURES

**Photo 7**

Screw of the motor band

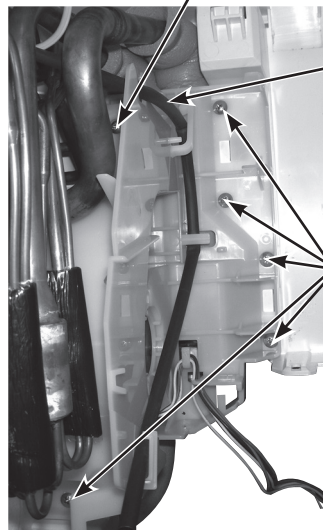

Lead wire of pipe thermistor

Screws of the motor bed

**Photo 8**

Screw of the line flow fan



### 7. Removing the pipe temperature thermistor/liquid (TH2) and the condenser/evaporator temperature thermistor (TH5)

- (1) Remove the panel and the corner box. (Refer to step 1)
- (2) Remove the electrical box covers. (Refer to step 2)
- (3) Remove the water cut. (See Photo 2)
- (4) Remove the pipe temperature thermistor/liquid and the condenser/evaporator temperature thermistor.
- (5) Disconnect the connector (CN44) on the indoor controller board.

**Photo 10**

Condenser/evaporator temperature thermistor (TH5)

Pipe temperature thermistor/liquid (TH2)

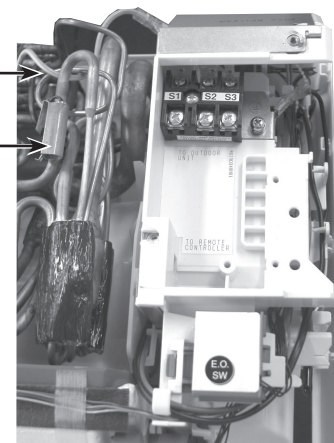

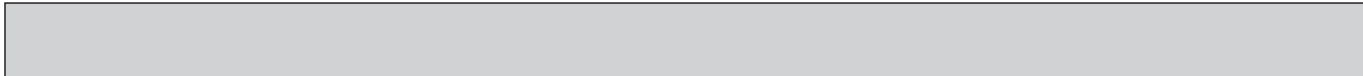

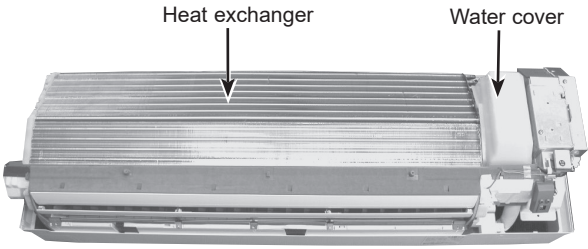
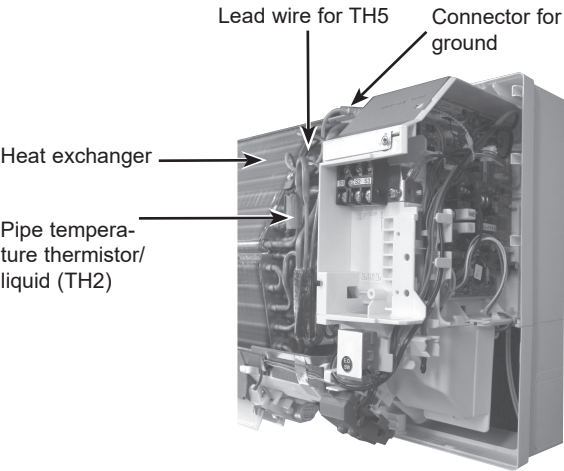
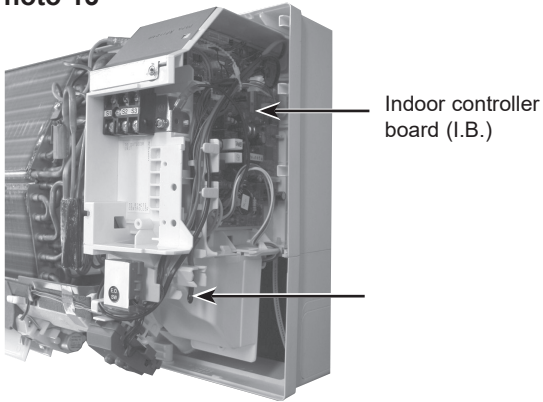
OPERATION PROCEDURE	PHOTOS/FIGURES
<p><b>8. Removing the heat exchanger</b></p> <ol style="list-style-type: none"><li>(1) Remove the panel and the corner box. (Refer to step 1)</li><li>(2) Remove the electrical box (Refer to step 3) and the nozzle assembly (Refer to step 4).</li><li>(3) Remove the water cut.</li><li>(4) Remove the pipe thermistors from each holder.</li><li>(5) Disconnect the connector for ground wire.</li><li>(6) Remove 3 screws fixing the left side of the heat exchanger. (See Photo 9)</li><li>(7) Remove the heat exchanger.</li></ol>	<p><b>Photo 11</b></p>  <p>Heat exchanger</p> <p>Water cover</p> <p><b>Photo 12</b></p>  <p>Lead wire for TH5</p> <p>Connector for ground</p> <p>Heat exchanger</p> <p>Pipe temperature thermistor/liquid (TH2)</p>
<p><b>9. Removing the room temperature thermistor</b></p> <ol style="list-style-type: none"><li>(1) Remove the panel and corner box. (Refer to step 1)</li><li>(2) Remove the electrical box covers.</li><li>(3) Remove the room temperature thermistor.</li><li>(4) Disconnect the connector (CN20) on the indoor controller board.</li></ol>	<p><b>Photo 13</b></p>  <p>Indoor controller board (I.B.)</p>

13-1. REMOTE CONTROLLER FUNCTIONS

<PAR-42MAAUB>

Controller interface

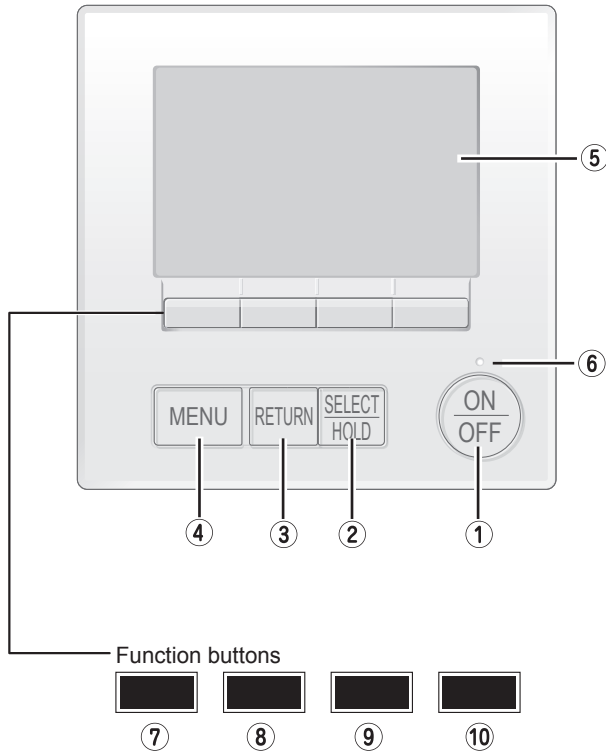

The functions of the function buttons change depending on the screen.

Refer to the button function guide that appears at the bottom of the LCD for the functions they serve on a given screen.

When the system is centrally controlled, the button function guide that corresponds to the locked button will not appear.

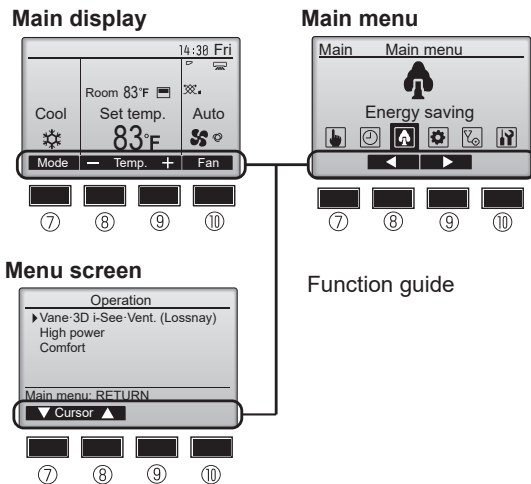

① [ON/OFF] button

Press to turn ON/OFF the indoor unit.

② [SELECT/HOLD] button

Press to save the setting.  
When the Main menu is displayed, pressing this button will enable/disable the HOLD function.

③ [RETURN] button

Press to return to the previous screen.

④ [MENU] button

Press to bring up the Main menu.

⑤ Backlit LCD

Operation settings will appear.  
When the backlight is off, pressing any button turns the backlight on and it will stay lit for a certain period of time depending on the screen.

When the backlight is off, pressing any button turns the backlight on and does not perform its function. (except for the [ON/OFF] button)

⑥ ON/OFF lamp

This lamp lights up in green while the unit is in operation. It blinks while the remote controller is starting up or when there is an error.

⑦ Function button [F1]

Main display: Press to change the operation mode.  
Menu screen: The button function varies with the screen.

⑧ Function button [F2]

Main display: Press to decrease temperature.  
Main menu: Press to move the cursor left.  
Menu screen: The button function varies with the screen.

⑨ Function button [F3]

Main display: Press to increase temperature.  
Main menu: Press to move the cursor right.  
Menu screen: The button function varies with the screen.

⑩ Function button [F4]

Main display: Press to change the fan speed.  
Menu screen: The button function varies with the screen.

## Display

The main display can be displayed in two different modes: "Full" and "Basic". The initial setting is "Full". To switch to the "Basic" mode, change the setting on the Main display setting. (Refer to operation manual included with remote controller.)

### <Full mode>

All icons are displayed for explanation.

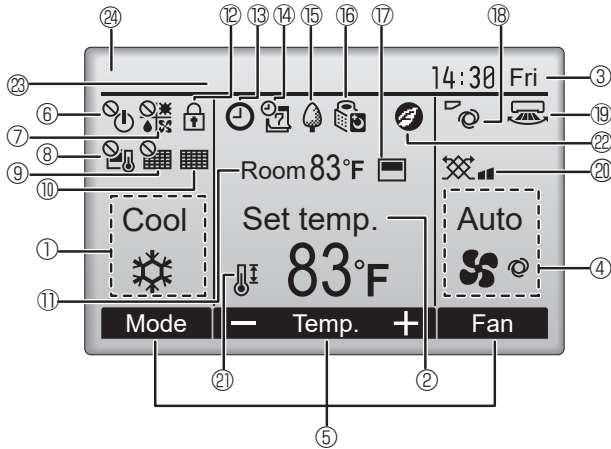

### <Basic mode>

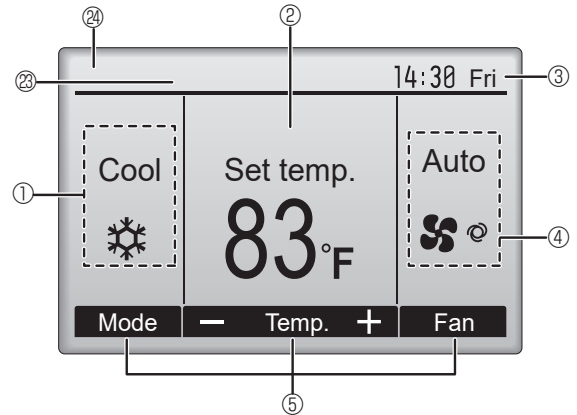

#### ① Operation mode

#### ② Preset temperature

#### ③ Clock

#### ④ Fan speed

#### ⑤ Button function guide

Functions of the corresponding buttons appear here.



Appears when the ON/OFF operation is centrally controlled.



Appears when the operation mode is centrally controlled.



Appears when the preset temperature is centrally controlled.



Appears when the filter reset function is centrally controlled.



Indicates when filter needs maintenance.

#### ⑪ Room temperature



Appears when the buttons are locked.



Appears when the On/Off timer or Auto-off timer function is enabled.

appears when the timer is disabled by the centralized control system.  
 appears when the HOLD function is enable.



Appears when the Weekly timer is enabled.



Appears while the units are operated in the energy saving mode. (Will not appear on some models of indoor units)



Appears while the outdoor units are operated in the silent mode.



Appears when the built-in thermistor on the remote controller is activated to monitor the room temperature (1).

appears when the thermistor on the indoor unit is activated to monitor the room temperature.



Indicates the vane setting.



Indicates the louver setting.



Indicates the ventilation setting.



Appears when the preset temperature range is restricted.



Appears when an energy saving operation is performed using a "3D i-see Sensor" function.

#### ⑳ Centrally controlled

Appears for a certain period of time when a centrally-controlled item is operated.

#### ㉑ Preliminary error display

A check code appears during the preliminary error.

Most settings (except ON/OFF, mode, fan speed, temperature) can be made from the Main menu.

## Menu structure

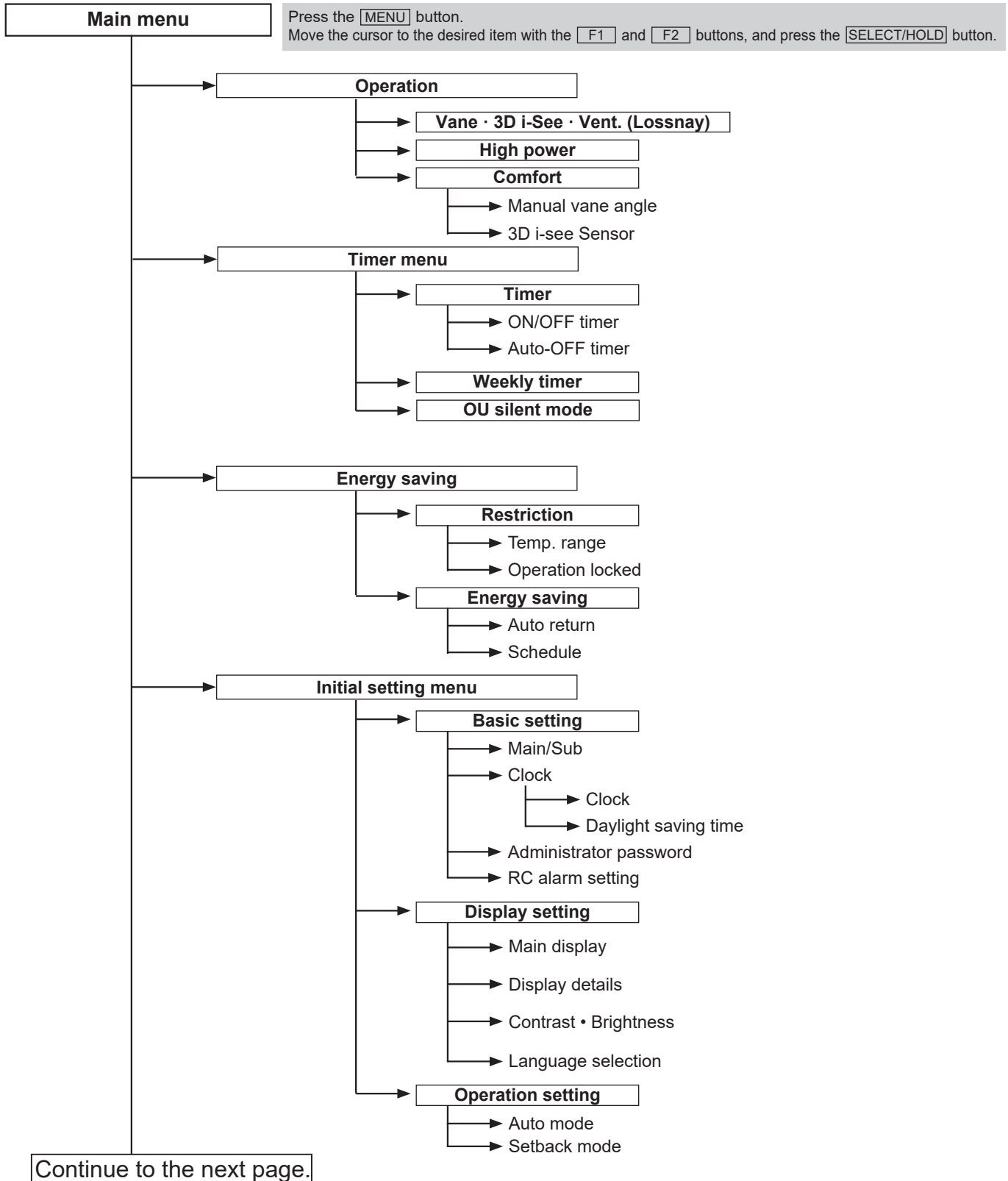

Not all functions are available on all models of indoor units.

Continue from the previous page.

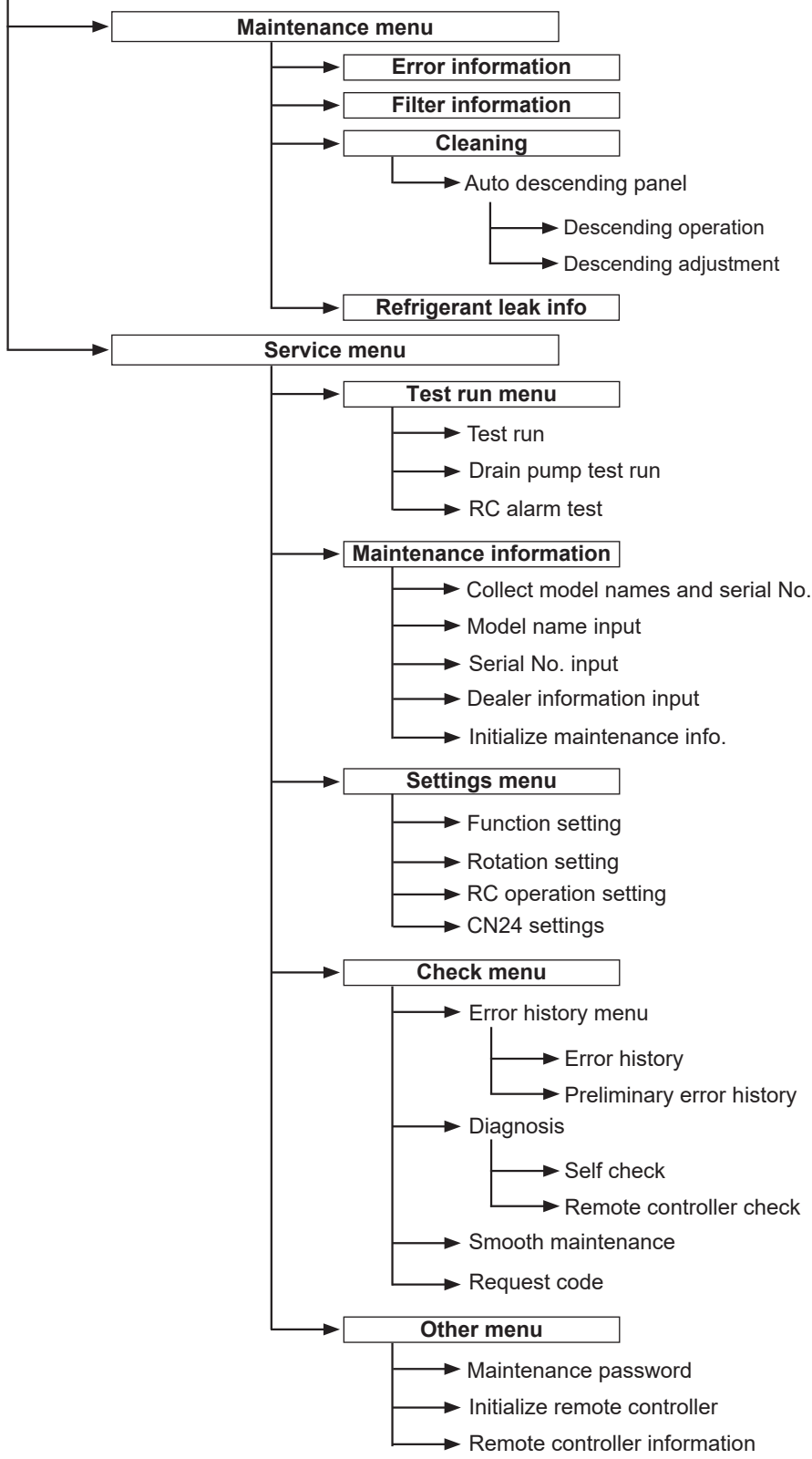

Not all functions are available on all models of indoor units.

## Main menu list

Main menu	Setting and display items		Setting details
Operation	Vane•3D i-See•Vent. (Lossnay) Vane · Louver · Vent. (Lossnay)		<p><b>Vane:</b> Use to set the vertical air direction.</p> <p><b>Louver:</b> Use to set the horizontal air direction.</p> <p><b>3D i-See sensor:</b> This setting is available only for the air conditioners that support easy setting function of motion sensing air direction.</p> <p><b>Vent:</b> Use to set the amount of ventilation.</p> <p><b>Use to set the vane angle.</b></p> <ul style="list-style-type: none"> <li>• Select a desired vane setting.</li> </ul> <p><b>Use to turn ON/OFF the louver.</b></p> <ul style="list-style-type: none"> <li>• Select a desired setting from "ON" and "OFF."</li> </ul> <p><b>Use to set the amount of ventilation.</b></p> <ul style="list-style-type: none"> <li>• Select a desired setting from "Off," "Low," and "High."</li> </ul>
	High power *3		<p><b>Use to reach the comfortable room temperature quickly.</b></p> <ul style="list-style-type: none"> <li>• Units can be operated in the High-power mode for up to 30 minutes.</li> </ul>
	Comfort	Manual vane angle	Use to fix each vane angle.
		3D i-see Sensor	<p><b>Use to set the following functions for 3D i-see Sensor.</b></p> <ul style="list-style-type: none"> <li>• Air distribution</li> <li>• Energy saving option</li> <li>• Seasonal airflow</li> </ul>
Timer	Timer	ON/OFF timer *1	<p><b>Use to set the operation ON/OFF times.</b></p> <ul style="list-style-type: none"> <li>• Time can be set in 5-minute increments.</li> </ul>
		Auto-Off timer	<p><b>Use to set the Auto-Off time.</b></p> <ul style="list-style-type: none"> <li>• Time can be set to a value from 30 to 240 in 10-minute increments.</li> </ul>
	Weekly timer *1, *2		<p><b>Use to set the weekly operation ON/OFF times.</b></p> <ul style="list-style-type: none"> <li>• Up to 8 operation patterns can be set for each day. (Not valid when the ON/OFF timer is enabled.)</li> </ul>
	OU silent mode *1, *3		<p><b>Use to set the time periods in which priority is given to quiet operation of outdoor units over temperature control. Set the Start/Stop times for each day of the week.</b></p> <ul style="list-style-type: none"> <li>• Select the desired silent level from "Normal," "Middle," and "Quiet."</li> </ul>
Energy saving	Restriction	Temp. range *2	<p><b>Use to restrict the preset temperature range.</b></p> <ul style="list-style-type: none"> <li>• Different temperature ranges can be set for different operation modes.</li> </ul>
		Operation locked	<p><b>Use to lock selected functions.</b></p> <ul style="list-style-type: none"> <li>• The locked functions cannot be operated.</li> </ul>
	Energy saving	Auto return *2	<p><b>Use to get the units to operate at the preset temperature after performing energy saving operation for a specified time period.</b></p> <ul style="list-style-type: none"> <li>• Time can be set to a value from 30 and 120 in 10-minute increments. (This function will not be valid when the preset temperature ranges are restricted.)</li> </ul>
		Schedule *1, *3	<p><b>Set the start/stop times to operate the units in the energy saving mode for each day of the week, and set the energy saving rate.</b></p> <ul style="list-style-type: none"> <li>• Up to 4 energy saving operation patterns can be set for each day.</li> <li>• Time can be set in 5-minute increments.</li> <li>• Energy saving rate can be set to a value from 0% or 50 to 90% in 10% increments.</li> </ul>
Initial setting	Basic setting	Main/Sub	<b>When connecting 2 remote controllers, one of them needs to be designated as a sub controller.</b>
		Clock	<b>Use to set the current time.</b>
		Daylight saving time	<b>Set the daylight saving time.</b>
		Administrator password	<p><b>The administrator password is required to make the settings for the following items.</b></p> <ul style="list-style-type: none"> <li>• Timer setting</li> <li>• Energy saving setting</li> <li>• Weekly timer setting</li> <li>• Restriction setting</li> <li>• Outdoor unit silent mode setting</li> </ul>

\*1 Clock setting is required.

\*2 2°F (1°C) increments.

\*3 This function is available only when certain outdoor units are connected.



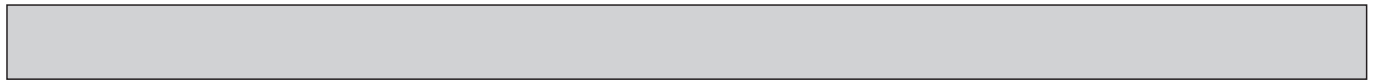

Main menu	Setting and display items		Setting details	
Initial setting	Display setting	Main display	Use to switch between "Full" and "Basic" modes for the Main display, and use to change the background colors of the display to black.	
		Display details	Make the settings for the remote controller related items as necessary. <b>Clock:</b> The initial settings are "Yes" and "24h" format. <b>Temperature:</b> Set either Celsius (°C) or Fahrenheit (°F). <b>Room temp.:</b> Set Show or Hide. <b>Auto mode:</b> Set Auto mode display or Only Auto display.	
		Contrast • Brightness	Use to adjust screen contrast and brightness.	
		Language selection	Use to select the desired language.	
	Operation setting	Auto mode	Whether or not to use Auto mode can be selected by using the button. This setting is valid only when indoor units with Auto mode function are connected.	
		Setback mode	Whether or not to use the Setback mode can be selected by using the button. This setting is valid only when indoor units with the Setback mode function are connected.	
Maintenance	Error information		Use to check error information when an error occurs. • Check code, error source, refrigerant address, model name, manufacturing number, contact information (dealer's phone number) can be displayed. (The model name, manufacturing number, and contact information need to be registered in advance to be displayed.)	
	Refrigerant leak info		Use to check error information when a refrigerant leakage occurs. • Error code, error source, refrigerant address, unit model, manufacturing number, contact information (dealer's phone number) can be displayed. * The unit model, manufacturing number, and contact information need to be registered in advance to be displayed.	
	Filter information		Use to check the filter status. • The filter sign can be reset.	
	Cleaning	Auto descending panel	Use to lift and lower the auto descending panel (Optional parts).	
Service	Test run		Select "Test run" from the Service menu to bring up the Test run menu. • Test run • Drain pump test run	
	Input maintenance		Select "Input maintenance Info." from the Service menu to bring up the Maintenance information screen. The following settings can be made from the Maintenance Information screen. • Model name input • Serial No. input • Dealer information input • Initialize maintenance info.	
	Settings	Function setting	Make the settings for the indoor unit functions via the remote controller as necessary.	
	Check	Error history		Display the error history and execute "delete error history".
		Diagnosis		<b>Self check:</b> Error history of each unit can be checked via the remote controller. <b>Remote controller check:</b> When the remote controller does not work properly, use the remote controller checking function to troubleshoot the problem.
		Smooth maintenance *1		Use to display the maintenance data of indoor/outdoor units.
		Request code *1		Use to check operation data such as thermistor temperature and error information.
	Others	Maintenance password		Use to change the maintenance password.
		Initialize remote controller		Use to initialize the remote controller to the factory shipment status.
		Remote controller information		Use to display the remote controller model name, software version, and serial number.

\*1 This function is available only when certain outdoor units are connected.

<PAR-SL101A-E>

**Controller interface**

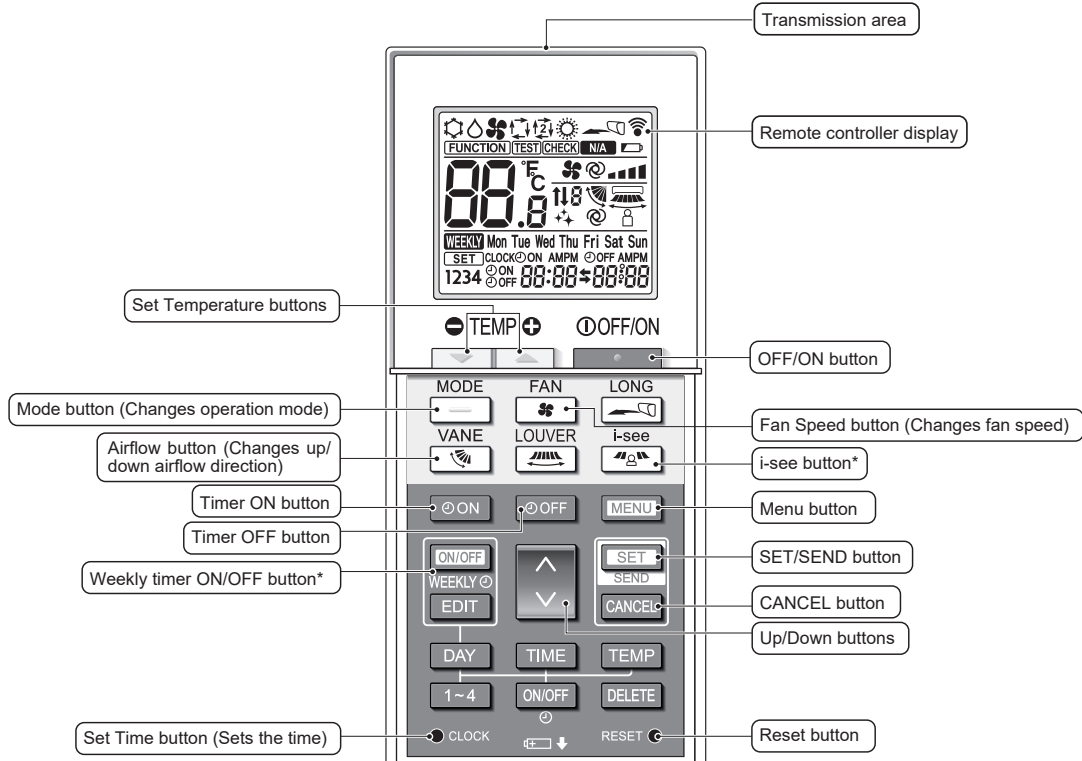

**Note:**

\* This button is enabled or disabled depending on the model of the indoor unit.

**Display**

**Operation mode**

	Cool		Dry
	Fan		Auto (single set point)
	Heat		Auto (dual set point)

**Temperature setting**  
The units of temperature can be changed. For details, refer to the Installation Manual.

**Vane setting**

Step 1 Step 2 Step 3 Step 4 Step 5 Swing Auto

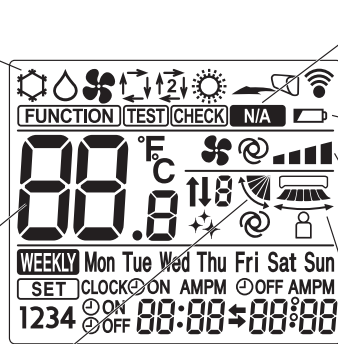

**Not available**  
Appears when a non-supported function is selected.

**Battery replacement indicator**  
Appears when the remaining battery power is low.

**Fan speed setting**

Auto

**3D i-see Sensor (Air distribution)**

Default Direct Indirect

When Direct or Indirect is selected, the vane setting is set to "Auto".

## 13-2. ERROR INFORMATION

**When an error occurs, the following screen will appear.  
Check the error status, stop the operation, and consult your dealer.**

1. Check code, error unit, refrigerant address, model name, and serial number will appear.  
The model name and serial number will appear only if the information has been registered.

Press the [F1] or [F2] button to go to the next page.

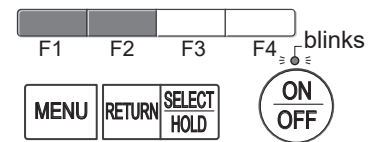
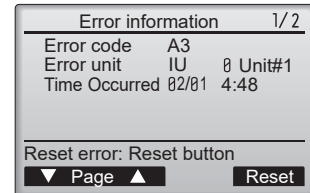

Contact information (dealer's phone number) will appear if the information has been registered.



2. Press the [F4] button or the [ON/OFF] button to reset the error that is occurring.

**Errors cannot be reset while the ON/OFF operation is prohibited.**

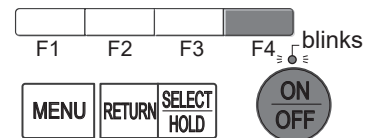
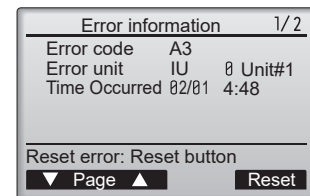

Select "OK" with the [F4] button.

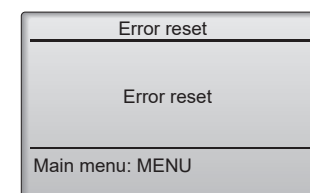
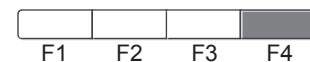
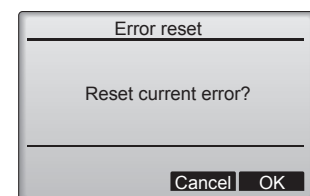

### Navigating through the screens

- To go back to the Service menu ..... [MENU] button

## • Checking the error information

While no errors are occurring, page 2/2 of the error information can be viewed by selecting "Error information" from the Maintenance menu. Errors cannot be reset from this screen.

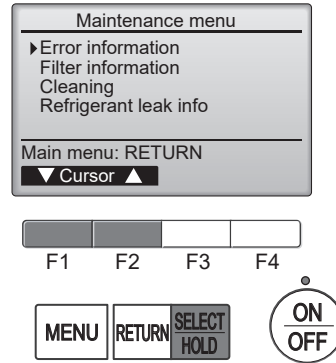

### 13-3. SERVICE MENU

**Maintenance password is required**

1. Select "Service" from the Main menu, and press the [SELECT/HOLD] button.

\*At the main display, the menu button and select "Service" to make the maintenance setting.

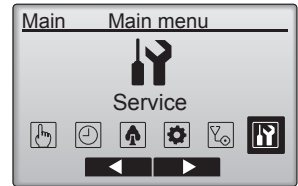

2. When the Service menu is selected, a window will appear asking for the password.

To enter the current maintenance password (4 numerical digits), move the cursor to the digit you want to change with the [F1] or [F2] button.



Set each number (0 through 9) with the [F3] or [F4] button.



Then, press the [SELECT/HOLD] button.

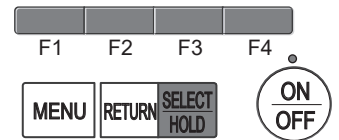
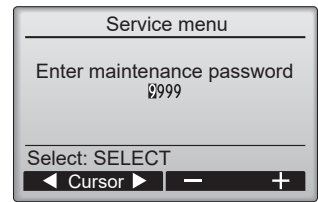

**Note:** The initial maintenance password is "9999". Change the default password as necessary to prevent unauthorized access. Have the password available for those who need it.

: If you forget your maintenance password, you can initialize the password to the default password "9999" by pressing and holding the [F1] button for 10 seconds on the maintenance password setting screen.

3. If the password matches, the Service menu will appear.

The type of menu that appears depends on the connected indoor units' type.

**Note:** Air conditioning units may need to be stopped to make only at "Settings". There may be some settings that cannot be made when the system is centrally controlled.



A screen will appear that indicates the setting has been saved.

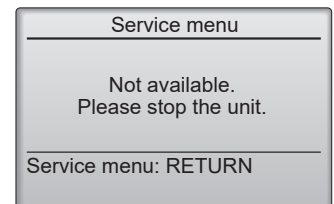
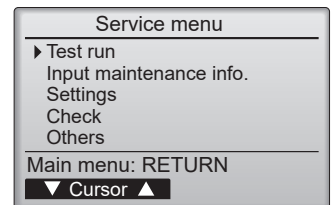

**Navigating through the screens**

- To go back to the Service menu ..... [MENU] button
- To return to the previous screen..... [RETURN] button

## 13-4. TEST RUN

### 13-4-1. PAR-42MAAUB

1. Select "Service" from the Main menu, and press the [SELECT/HOLD] button.

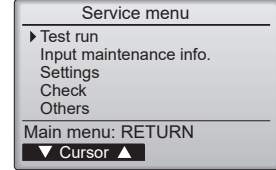

Select "Test run" with the [F1] or [F2] button, and press the [SELECT/HOLD] button.

2. Select "Test run" with the [F1] or [F2] button, and press the [SELECT/HOLD] button.

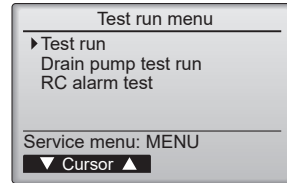

#### Test run operation

Press the [F1] button to go through the operation modes in the order of "Cool and Heat".

Cool mode: Check the cold air blows out.  
Heat mode: Check the heat blows out.

Check the operation of the outdoor unit's fan.

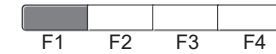
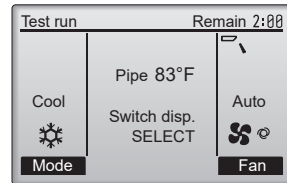

Press the [SELECT/HOLD] button and open the Vane setting screen.

#### Auto vane check

Check the auto vane with the [F1] [F2] buttons.

Press the [RETURN] button to return to "Test run operation".



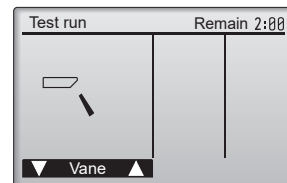







Press the [ON/OFF] button.



When the test run is completed, the "Test run menu" screen will appear. The test run will automatically stop after 2 hours.

\*The function is available only for the model with vanes.

### 13-4-2. PAR-SL101A-E

1. Press the  button ① to stop the air conditioner.
  - If the weekly timer is enabled (**WEEKLY** is on), press the  button ③ to disable it (**WEEKLY** is off).
2. Press the  button ② for 5 seconds.
  - **CHECK** comes on and the unit enters the service mode.
3. Press the  button ②.
  - **TEST** ④ comes on and the unit enters the test run mode.
4. Press the following buttons to start the test run.
  - : Switch the operation mode between cooling and heating and start the test run.
  - : Switch the fan speed and start the test run.
  - : Switch the airflow direction and start the test run.
  - : Switch the louver and start the test run.
  - : Start the test run.
5. Stop the test run.
  - Press the  button ① to stop the test run.
  - After 2 hours, the stop signal is transmitted.

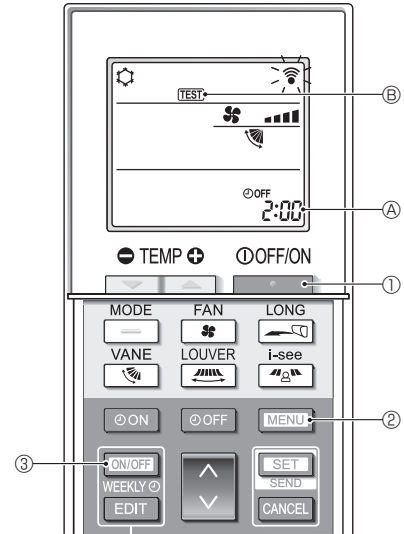

## 13-5. FUNCTION SETTING

### 13-5-1. PAR-42MAAUB

1. Select "Service" from the Main menu, and press the [SELECT/HOLD] button.

Select "Setting" from the Service menu, and press the [SELECT/HOLD] button.

Select "Function setting", and press the [SELECT/HOLD] button.

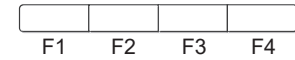
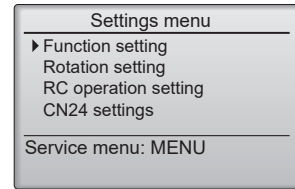

2. Set the indoor unit refrigerant addresses and unit numbers with the [F1] through [F4] buttons, and then press the [SELECT/HOLD] button to confirm the current setting.

#### Note: Checking the indoor unit No.

When the [SELECT/HOLD] button is pressed, the target indoor unit will start fan operation. If the unit is common or when running all units, all indoor units for the selected refrigerant address will start fan operation.

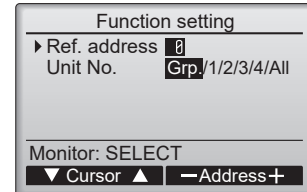

3. Toggle through the pages with the [F3] or [F4] button.  
Select the mode number with the [F1] or [F2] button, and then press the [SELECT/HOLD] button.

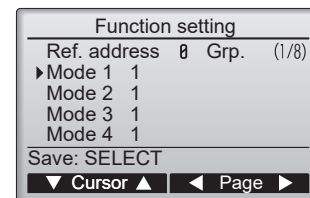

4. Select the setting number with the [F1] or [F2] button.  
Setting range for modes 1 through 28: 1 through 3  
Setting range for modes 31 through 66: 1 through 15

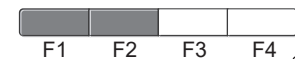
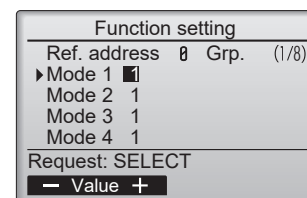

5. When the settings are completed, press the [SELECT/HOLD] button to send the setting data from the remote controller to the indoor units.  
When the transmission is successfully completed, the screen will return to the Function setting screen.

#### Note: • Make the above settings only on Mr. Slim units as necessary.

- The above function settings are not available for the CITY MULTI units.
- Refer to the indoor unit Installation Manual for the detailed information about initial settings, mode numbers, and setting numbers for the indoor units.
- Be sure to write down the settings for all functions if any of the initial settings has been changed after the completion of installation work.

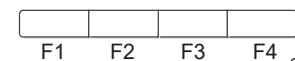
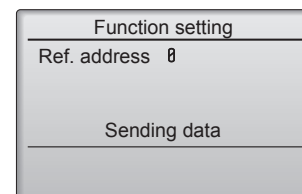



## 13-5-2. PAR-SL101A-E

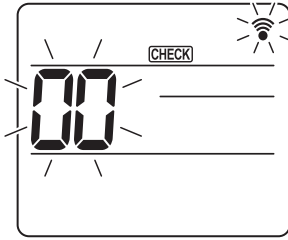

Fig. 1

### 1. Going to the function select mode

Press the **MENU** button between of 5 seconds.

(Start this operation from the status of remote controller display turned off.)

[CHECK] is lit and "00" blinks. (Fig. 1)

Press the **↓** button to set the "50".

Direct the wireless remote controller toward the receiver of the indoor unit and press the **SET** button.

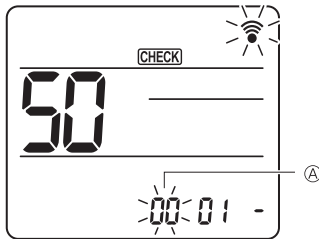

Fig. 2

### 2. Setting the unit number

Press the **↓** button to set unit number **A**. (Fig. 2)

Direct the wireless remote controller toward the receiver of the indoor unit and press the **SET** button.

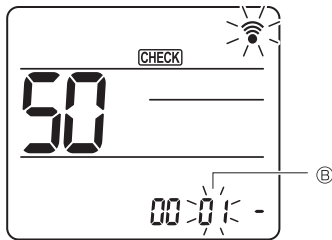

Fig. 3

### 3. Select a mode

Press the **↓** button to set Mode number **B**. (Fig. 3)

Direct the wireless remote controller toward the receiver of the indoor unit and press the **SET** button.

Current setting number:

1=1 beep (1 second)

2=2 beep (1 second each)

3=3 beep (1 second each)

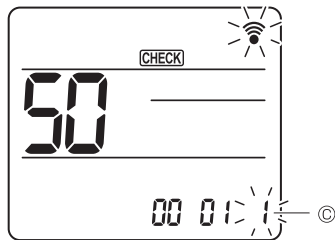

Fig. 4

### 4. Selecting the setting number

Use the **↓** button to change the Setting number **C**. (Fig. 4)

Direct the wireless remote controller toward the receiver of the indoor unit and press the **SET** button.

### 5. To select multiple functions continuously

Repeat select **3** and **4** to change multiple function settings continuously.

### 6. Complete function selection

Direct the wireless remote controller toward the sensor of the indoor unit and press the **OFF/ON** button.

**Note: Be sure to write down the settings for all functions if any of the initial settings has been changed after the completion of installation work.**

## 13-6. ERROR HISTORY

1. Select "Service" from the Main menu, and press the [SELECT/HOLD] button.



Select "Check" with the **[F1]** or **[F2]** button, and press the [SELECT/HOLD] button.

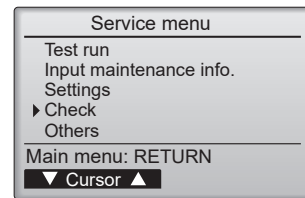

2. Select "Error history" with the **[F1]** or **[F2]** button, and press the [SELECT/HOLD] button.



Select "Error history" from the Error history menu, and press the [SELECT/HOLD] button.

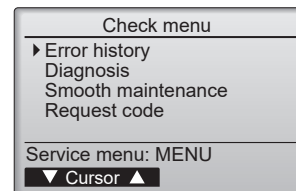

3. 16 error history records will appear.

4 records are shown per page, and the top record on the first page indicates the latest error record.

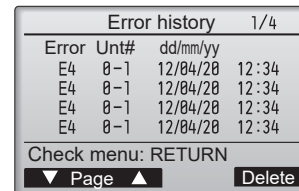

4. Deleting the error history

To delete the error history, press the **[F4]** button (Delete) on the screen that shows error history.

A confirmation screen will appear asking if you want to delete the error history.



Press the **[F4]** button (OK) to delete the history.



"Error history deleted" will appear on the screen.

Press the [RETURN] button to go back to the Check menu screen.

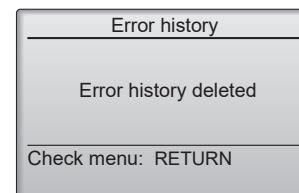
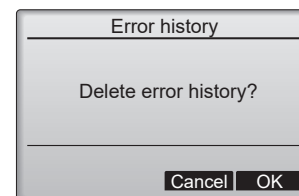

## 13-7. SELF-DIAGNOSIS

### 13-7-1. PAR-42MAAUB

1. Select "Service" from the Main menu, and press the [SELECT/HOLD] button.



Select "Check" from the Service menu, and press the [SELECT/HOLD] button.



Select "Diagnosis" from the Check menu, and press the [SELECT/HOLD] button.



Select "Self check" with the [F1] or [F2] button, and press the [SELECT/HOLD] button.

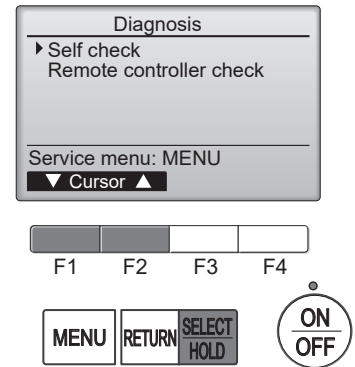

2. With the [F1] or [F2] button, enter the refrigerant address, and press the [SELECT/HOLD] button.

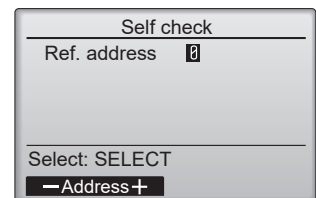

3. Check code, unit number, attribute will appear. "-" will appear if no error history is available.

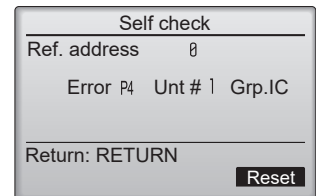

**When there is no error history**

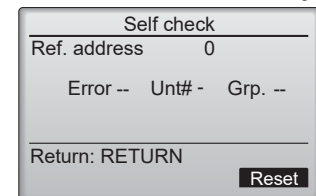

4. Resetting the error history

Press the [F4] button (Reset) on the screen that shows the error history.



A confirmation screen will appear asking if you want to delete the error history.



Press the [F4] button (OK) to delete the error history.

If deletion fails, "Request rejected" will appear. "Unit not exist" will appear if no indoor units that are correspond to the entered address are found.

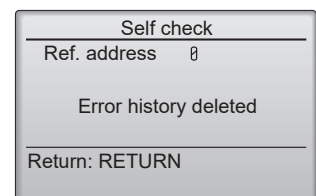
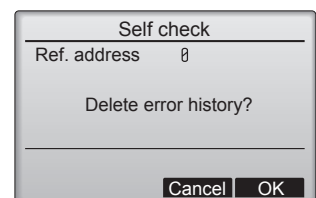

#### **Navigating through the screens**

- To go back to the Service menu ..... [MENU] button
- To return to the previous screen..... [RETURN] button

### 13-7-2. PAR-SL101A-E

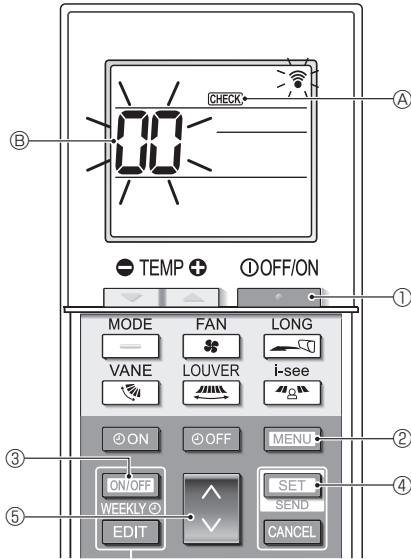

1. Press the button ① to stop the air conditioner.
  - If the weekly timer is enabled (**WEEKLY** is on), press the button ③ to disable it (**WEEKLY** is off).
2. Press the button ② for 5 seconds.
  - **CHECK** ① comes on and the unit enters the self-check mode.
3. Press the button ⑤ to select the refrigerant address (M-NET address) ② of the indoor unit for which you want to perform the self-check.
4. Press the button ④.
  - If an error is detected, the check code is indicated by the number of beeps from the indoor unit and the number of blinks of the OPERATION INDICATOR lamp.
5. Press the button ①.
  - **CHECK** ① and the refrigerant address (M-NET address) ② go off and the self-check is completed.

## 13-8. REMOTE CONTROLLER CHECK

If operations cannot be completed with the remote controller, diagnose the remote controller with this function.

1. Select "Service" from the Main menu, and press the [SELECT/HOLD] button.

Select "Check" from the Service menu, and press the [SELECT/HOLD] button.

Select "Diagnosis" from the Check menu, and press the [SELECT/HOLD] button.

Select "Remote controller check" with the [F1] or [F2] button, and press the [SELECT/HOLD] button.

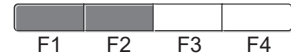
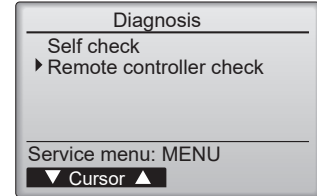

2. Select "Remote controller check" from the Diagnosis menu, and press the [SELECT/HOLD] button to start the remote controller check and see the check results.

To cancel the remote controller check and exit the "Remote controller check" menu screen, press the [MENU] or the [RETURN] button.

The remote controller will not reboot itself.

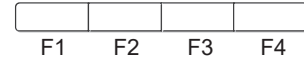
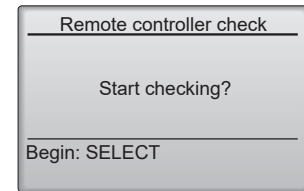

3.
  - OK: No problems are found with the remote controller. Check other parts for problems.
  - E3, 6832: There is noise on the transmission line, or the indoor unit or another remote controller is faulty. Check the transmission line and the other remote controllers.
  - NG (ALL0, ALL1): Send-receive circuit fault. The remote controller needs replacing.
  - ERC: The number of data errors is the discrepancy between the number of bits in the data transmitted from the remote controller and that of the data that was actually transmitted over the transmission line. If data errors are found, check the transmission line for external noise interference.

### Remote controller check results screen

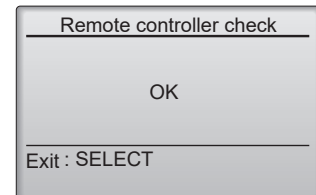

If the [SELECT/HOLD] button is pressed after the remote controller check results are displayed, remote controller check will end, and the remote controller will automatically reboot itself.

**Check the remote controller display and see if anything is displayed (including lines). Nothing will appear on the remote controller display if the correct voltage (8.5–12 VDC) is not supplied to the remote controller. If this is the case, check the remote controller wiring and indoor units.**

## 13-9. SMOOTH MAINTENANCE

1. Select "Service" from the Main menu, and press the [SELECT/HOLD] button.



Select "Check" with the [F1] or [F2] button, and press the [SELECT/HOLD] button.



Select "Smooth maintenance" with the [F1] or [F2] button, and press the [SELECT/HOLD] button.

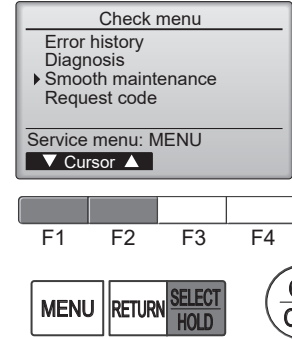

2. Set each item.

Select the item to be changed with the [F1] or [F2] button.

Select the required setting with the [F3] or [F4] button.

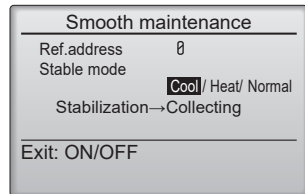
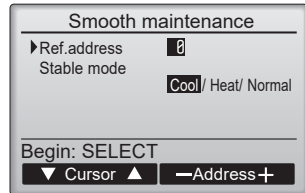

- <Ref.address> setting [ 0 ] – [ 15 ]
- <Stable mode> setting [ Cool ] / [ Heat ] / [ Normal ]

Press the [SELECT/HOLD] button, Fixed operation will start.

Note: Stable mode will take approx. 20 minutes.

3. The operation data will appear.

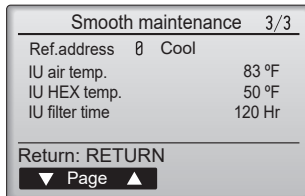
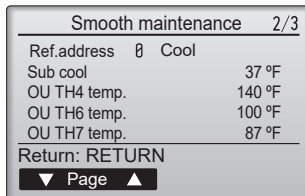
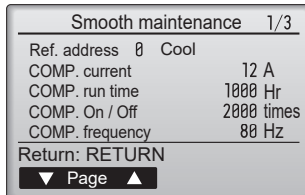

The Compressor-Accumulated operating (COMP. run) time is 10-hour unit, and the Compressor-Number of operation times (COMP. ON/OFF) is a 100-time unit (fractions discarded).

### Navigating through the screens

- To go back to the Service menu ..... [MENU] button
- To return to the previous screen ..... [RETURN] button

■ Refrigerant address

Single refrigerant system

In the case of single refrigerant system, the refrigerant address is "00" and no operation is required.

Simultaneous twin, triple units belong to this category (single refrigerant system).

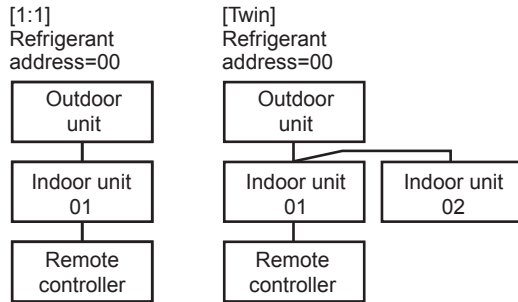

Multi refrigerant system (group control)

Up to 16 refrigerant systems (16 outdoor units) can be connected as a group by 1 remote controller. To check or set the refrigerant addresses.

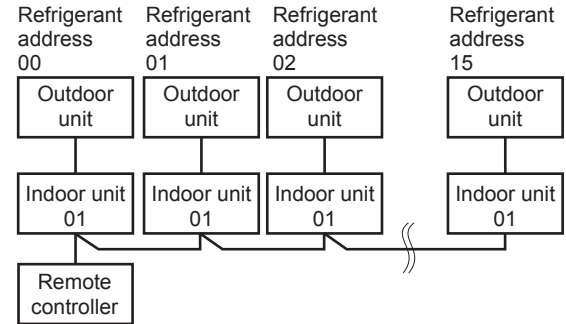

### 13-10. REQUEST CODE

Details on the operation data including each thermistor temperature and error history can be confirmed with the remote controller.

1. Select "Service" from the Main menu, and press the [SELECT/HOLD] button.

Select "Check" with the [F1] or [F2] button, and press the [SELECT/HOLD] button.

Select "Request code" with the [F1] or [F2] button, and press the [SELECT/HOLD] button.

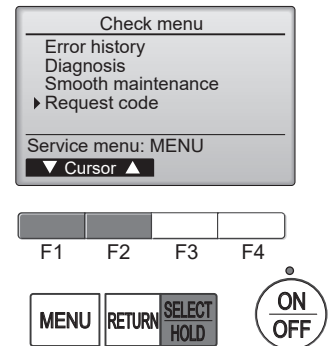

2. Set the Refrigerant address and Request code.

Select the item to be changed with the [F1] or [F2] button.

Select the required setting with the [F3] or [F4] button.

- <Ref.address>setting [ 0 ] – [ 15 ]
- <Request code>setting

Press the [SELECT/HOLD] button, Data will be collected and displayed.

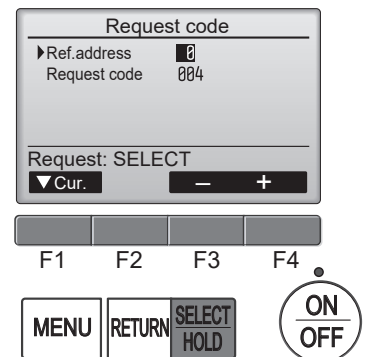

**Request code: 004**  
**Discharge temperature: 69°C**

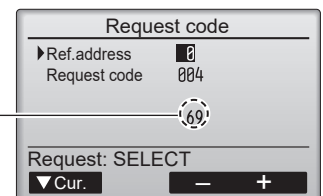

# **mitsubishi electric corporation**

HEAD OFFICE: TOKYO BUILDING, 2-7-3, MARUNOUCHI, CHIYODA-KU, TOKYO 100-8310, JAPAN

---